

Long Carbon Europe



ArcelorMittal

Perfiles y Barras Comerciales
Sections and Merchant Bars
Profili e Laminati Mercantili

Programa de Ventas / Sales Programme / Programma di vendita





Índice

Table of contents

Indice

5	Gamas de perfiles
159	Grados y calidades de acero
187	Datos técnicos
215	Datos comerciales y agencias

5	Section ranges
159	Steel grades and qualities
187	Technical data
215	Commercial data and agencies

5	Gamma dei profili
159	Qualità e caratteristiche degli acciai
187	Dati tecnici
215	Dati commerciali e consulenza



ArcelorMittal

ArcelorMittal es el líder mundial en la industria siderúrgica, con

Una plantilla de 320.000 empleados en más de 60 países, una presencia industrial en más de 27 países, un volumen de negocios de más de 70.000 millones de euros y una producción que supera los 120 millones de toneladas.

El grupo ofrece a su clientela multinacional una gama completa de productos de calidad así como soluciones globales que satisfacen las expectativas de los utilizadores en los principales ámbitos de aplicación.

Long Carbon Europe

es una de las principales unidades estratégicas en ArcelorMittal. Su principal mercado es el sector de la construcción que representa, para los actores de la industria del acero, una fuente de rentabilidad y de crecimiento sostenible.

Commercial Sections

es una de las unidades operacionales de Long Carbon Europe. Es responsable de las ventas, marketing y desarrollo de perfiles y barras comerciales.

Comercializa por todo el mundo una extensa gama de productos que satisfacen los más estrictos requisitos técnicos, cualitativos y ambientales. La satisfacción de los clientes, los buenos resultados y la innovación son sus objetivos prioritarios.

Una asistencia técnica y un software de fácil utilización están a disposición de los clientes para ayudarles en el diseño de proyectos económicos, seguros y sostenibles.

ArcelorMittal is the world leader in steel industry, with

320,000 employees in over 60 countries, an industrial presence in more than 27 countries, a turnover of more than 70 billion euro and a production output exceeding 120 million tonnes.

The group offers its multinational customers a full range of quality products as well as global solutions which meet the users' expectations in their main application domains.

Long Carbon Europe

is one of the major strategic units in ArcelorMittal. Its principal market is the construction sector which represents a source of profitability and sustainable growth for the key players of the steel industry.

Commercial Sections

is the operational unit in Long Carbon Europe responsible for sales, marketing and development of sections and merchant bars.

Throughout the world it offers an extensive range of products meeting the strictest technical, quality and environmental requirements. Customer satisfaction, performance and innovation are its priority objectives.

Technical assistance and user-friendly software are made available to customers as a support in their design of economic, safe, and sustainable projects.

ArcelorMittal è il leader mondiale nell'industria siderurgica con

320,000 dipendenti in più di 60 paesi, una presenza produttiva in più di 27 paesi, un fatturato di oltre 70 miliardi di euro e una produzione che supera i 120 milioni di tonnellate.

Il gruppo offre ai suoi clienti internazionali una gamma completa di prodotti e soluzioni per soddisfare le aspettative dei clienti nei rispettivi ambiti di applicazione.

Long Carbon Europe

una delle principali unità strategiche della ArcelorMittal. Il suo principale mercato è il settore delle costruzioni che rappresenta, per gli attori dell'industria dell'acciaio fonte di redditività e crescita sostenibile.

Commercial Sections

È l'unità operativa all'interno di Long Carbon Europe responsabile per le vendite, marketing e sviluppo per i Profili a lunghezza fissa e i laminati mercantili.

Offre in tutto il mondo una vasta gamma di prodotti che soddisfano i più severi requisiti tecnici, qualitativi e ambientali. Soddisfazione della clientela, innovazione e sviluppo del prodotto sono i suoi obiettivi prioritari.

Assistenza tecnica e software di facile uso sono disponibili come supporto ai clienti per permettere loro lo sviluppo di progetti in modo economico, sicuro e sostenibile.



Gamas de perfiles

- 15 Perfiles europeos y comerciales
- 75 Perfiles derivados y soluciones innovadoras
- 97 Perfiles británicos
- 115 Perfiles americanos
- 153 Perfiles japoneses

Section ranges

- 15 European sections and merchant bars
- 75 Derived sections and innovative solutions
- 97 British sections
- 115 American sections
- 153 Japanese sections

Gamma dei profili

- 15 Profili europei e laminati mercantili
- 75 Travi derivate e soluzioni innovative
- 97 Profili britannici
- 115 Profili americani
- 153 Profili giapponesi

Gamas de perfiles europeos 1









Dimensiones nominales: altura en mm

European section ranges 1

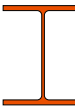
Nominal sizes: depth in mm

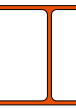
Gamma dei profili europei 1

Dimensioni nominali: altezza in mm

										
	IPE	IPN	HE	HL	HD	HP	UPE	UPN	U	UE
	páginas/pages/ pagine 16-21	páginas/pages/ pagine 22-23	páginas/pages/ pagine 24-31	páginas/pages/ pagine 32-35	páginas/pages/ pagine 36-39	páginas/pages/ pagine 40-43	páginas/pages/ pagine 44-45	páginas/pages/ pagine 46-47	páginas/pages/ pagine 48-49	páginas/pages/ pagine 50-51
Altura	Perfiles I de alas paralelas	Perfiles I de alas inclinadas	Perfiles H de alas anchas	Perfiles H de alas muy anchas	Perfiles H de alas anchas para pilares	Perfiles H de alas anchas para pilotes	Perfiles U de alas paralelas	Perfiles U estándar de alas inclinadas	Perfiles U comerciales de alas inclinadas	Perfiles U comerciales de alas inclinadas
Depth	Parallel flange I sections	Taper flange I sections	Wide flange beams	Extra wide flange beams	Wide flange columns	Wide flange bearing piles	Channels with parallel flanges	Standard channels	Channels with taper flanges	Channels with taper flanges
Altezza	Profili I ad ali parallele	Profili I ad ali inclinate	Profili H ad ali larghe	Profili H ad ali extra larghe	Profili H portanti a spessore maggiorato	Profili H portanti ad ali extra larghe	Profili U ad ali parallele	Profili U ad ali inclinate	Profili U ad ali inclinate	Profili U ad ali inclinate

40									U 40	
50									U 50	
60								UPN 50	U 60	
65								UPN 65	U 65	
80	IPE 80	IPN 80					UPE 80	UPN 80		UE 80
100	IPE 100	IPN 100	HE 100				UPE 100	UPN 100		UE 100
120	IPE 120	IPN 120	HE 120				UPE 120	UPN 120		UE 120
140	IPE 140	IPN 140	HE 140				UPE 140	UPN 140		UE 140
160	IPE 160	IPN 160	HE 160				UPE 160	UPN 160		UE 160
180	IPE 180	IPN 180	HE 180				UPE 180	UPN 180		UE 180
200	IPE 200	IPN 200	HE 200			HP 200	UPE 200	UPN 200		UE 200
220	IPE 220	IPN 220	HE 220			HP 220	UPE 220	UPN 220		
240	IPE 240	IPN 240	HE 240				UPE 240	UPN 240		
250										
260		IPN 260	HE 260		HD 260	HP 260		UPN 260		
270	IPE 270						UPE 270	UPN 280		
280		IPN 280	HE 280							
300	IPE 300	IPN 300	HE 300			HP 305	UPE 300	UPN 300		
320		IPN 320	HE 320		HD 320	HP 320		UPN 320		
330	IPE 330						UPE 330			
340		IPN 340	HE 340							
360	IPE 360	IPN 360	HE 360		HD 360	HP 360	UPE 360	UPN 350		
380		IPN 380						UPN 380		
400	IPE 400	IPN 400	HE 400		HD 400	HP 400	UPE 400	UPN 400		
450	IPE 450	IPN 450	HE 450							
500	IPE 500	IPN 500	HE 500							
550	IPE 550	IPN 550	HE 550							
600	IPE 600	IPN 600	HE 600							
650			HE 650							
700			HE 700							
750	IPE 750									
800			HE 800							
900			HE 900							
920					HL 920					
1000			HE 1000		HL 1000					
1100					HL1100					

Gamas de perfiles europeos 2







Dimensiones nominales: altura/diámetro en mm

European section ranges 2

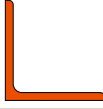
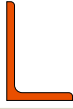
Nominal sizes: depth/ diameter in mm

Gamma dei profili europei 2

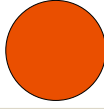
Dimensioni nominali: altezza/diametro in mm

							
	L	L	FL	SQ	SQ	R	T
	páginas/pages/pagine 52-63	páginas/pages/pagine 64-69	página/page/pagina 70	página/page/pagina 71	página/page/pagina 71	página/page/pagina 72	página/page/pagina 73
Altura/ Diámetro	Perfiles angulares de lados iguales	Perfiles angulares de lados desiguales	Pletinas y llantas (ancho para FL)	Barras cuadradas con aristas redondeadas	Barras cuadradas con aristas vivas	Barras redondas de acero laminadas en caliente	Perfil en T de alas iguales
Depth/ Diameter	Equal leg angles	Unequal leg angles	Flat bars (width for FL)	Square bars with rounded edges	Square bars with sharp edges	Hot rolled steel bars	Equal flange tees
Altezza/ Diametro	Angolari a lati uguali	Angolari a lati diseguali	Piatti e larghi piatti	Quadri a spigoli arrotondati	Quadri a spigoli vivi	Tondi laminati a caldo	Profili T ad ali uguali

10						R 10	
20	L 20					↑	
25	L 25						
30	L 30						T 30
35	L 35						T 35
40	L 40		40				T 40
45	L 45			45	45		
50	L 50		50	50	50		T 50
55	L 55			55	55		
60	L 60		60	60	60		T 60
65	L 65			65			
70	L 70		70	70			T 70
75	L 75						
80	L 80		80	80			T 80
85				85			
90	L 90		90		90		
95				95			
100	L 100	L 100	100	100	100		
110	L 110	L 110	110		110		
120	L 120	L 120	120		120		
125		L 125					
130	L 130	L 130	130		130		
140		L 140	140	140			
150	L 150	L 150	150	150			
160	L 160		160	160			
170			170				
180	L 180		180				
200	L 200	L 200	200				
203							
220							
250	L 250						
300							
350							
400							

Perfiles derivados / Derived sections / Travi derivate

Vigas alveolares

Castellated beams

Travi alveolari

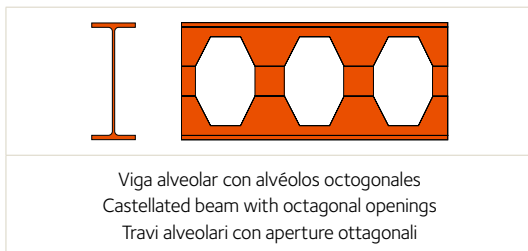
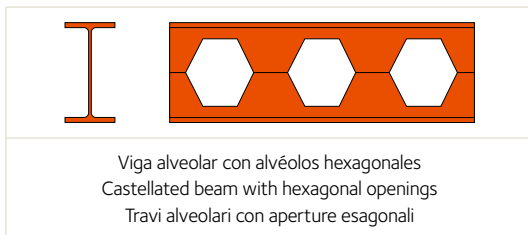
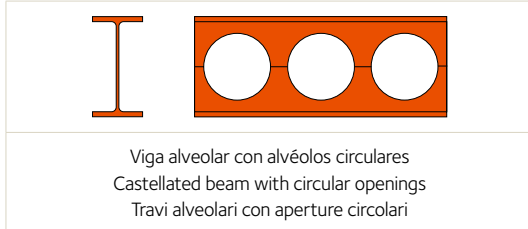

IPE	HE	HL
páginas/pages/pagine 76-90	páginas/pages/pagine 76-90	páginas/pages/pagine 76-90
Perfiles básicos Base profiles Profili di base		

200		
220		
240		
	260	
270		
	280	
300	300	
	320	
330		
	340	
360	360	
400	400	
450	450	
500	500	
550	550	
600	600	
	650	
	700	
750		
	800	
	900	
	1000	920
		1000
		1100

Selección de perfiles IFB y SFB

Integrated Floor Beam IFB; Slim Floor Beam SFB

Vigas fabricadas a partir de perfiles y chapas laminadas en caliente

Selection of IFB and SFB beams

Integrated Floor Beam IFB; Slim Floor Beam SFB

Beams built-up from hot-rolled sections and plates

Gamma di travi IFB e SFB

Travi IFB e SFB integrate in spessore per solai

Travi ricavate da profili e lamiere laminate a caldo

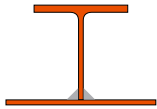
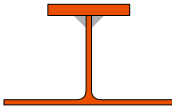
		
IFB		SFB
páginas/pages/pagine 91-93		páginas/pages/pagine 91-93
Perfiles qualità A Type A beams Travi qualità A		páginas/pages/pagine 94-96 Perfiles Beams Travi

				HE 140 + □
				HE 160 + □
				HE 180 + □
				HE 200 + □
				HE 220 + □
				HE 240 + □
				HE 260 + □
				HE 280 + □
				HE 300 + □
				HE 320 + □
	1/2 HE 220 + □			
	1/2 HE 240 + □			
	1/2 HE 260 + □			
	1/2 HE 280 + □	1/2 HE 280 + □		
	1/2 HE 300 + □	1/2 HE 300 + □		
	1/2 HE 320 + □			
	1/2 HE 340 + □			
	1/2 HE 360 + □		1/2 HP 360 + □	
1/2 IPE 400 + □	1/2 HE 400 + □		1/2 HP 400 + □	
1/2 IPE 450 + □	1/2 HE 450 + □			
1/2 IPE 500 + □	1/2 HE 500 + □			
1/2 IPE 550 + □	1/2 HE 550 + □			
1/2 IPE 600 + □	1/2 HE 600 + □			
	1/2 HE 650 + □			

Gamas de perfiles británicos*





Dimensiones nominales: altura x ancho en mm

British section ranges*



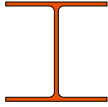

Nominal sizes: depth x width in mm

Gamma dei profili britannici*

Dimensioni nominali: altezza x larghezza in mm

						
	UB	J	UC	UBP	PFC	CH
	páginas/pages/pagine 98-103	páginas/pages/pagine 104-105	páginas/pages/pagine 106-107	páginas/pages/pagine 108-109	páginas/pages/pagine 110-111	páginas/pages/pagine 112-113
Altura	Perfiles I de alas paralelas	Perfiles I de alas inclinadas	Perfiles H de alas anchas y caras paralelas para pilares	Perfiles H de alas anchas y caras paralelas para pilotes	Perfiles U de alas paralelas	Perfiles U comerciales de alas inclinadas
Depth	Universal beams	Joists with taper flanges	Universal columns	Wide flange bearing piles	Parallel flange channels	Channels with taper flanges
Altezza	Profili I ad ali parallele	Profili I ad ali inclinate	Profili H portanti	Profili H portanti ad ali larghe	Profili U ad ali parallele	Profili U ad ali inclinate

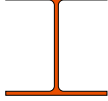
76		J 76x76				CH 76x38
89		J 89x89				
100					PFC 100x50	
102		J 102x44/102				CH 102x51
114		J 114x114				
125					PFC 125x65	
127	UB 127x76	J 127x76/114				CH 127x64
150					PFC 150x75/90	
152	UB 152x89	J152x127	UC 152x152			CH 152x76/89
178	UB 178x102					CH 178x76/89
180					PFC 180x75/90	
200					PFC 200x75/90	
203	UB 203x102/133	J 203x152	UC 203x203	UBP 203x203		CH 203x76/89
229						CH 229x76/89
230					PFC 230x75/90	
245						CH 254x76/89
254	UB 254x102/146	J 254x114/203	UC 254 x 254	UBP 254x254		
260					PFC 260x75/90	
300					PFC 300x90/100	
305	UB 305x102/127/165		UC 305x305	UBP 305x305		CH 305x89/102
356	UB 356x127/171		UC 356x368/406	UBP 356x368		
380					PFC 380x100	CH 381x102

						
	UB	J	UC	UBP	PFC	CH
	páginas/pages/pagine 98-103	páginas/pages/pagine 104-105	páginas/pages/pagine 106-107	páginas/pages/pagine 108-109	páginas/pages/pagine 110-111	páginas/pages/pagine 112-113
Altura	Perfiles I de alas paralelas	Perfiles I de alas inclinadas	Perfiles H de alas anchas y caras paralelas para pilares	Perfiles H de alas anchas y caras paralelas para pilotes	Perfiles U de alas paralelas	Perfiles U de alas inclinadas
Depth	Universal beams	Taper flange I sections	Universal columns	Wide flange bearing piles	Parallel flange channels	Taper flange channels
Altezza	Profili I ad ali parallele	Profili I ad ali inclinate	Profili H portanti	Profili H portanti ad ali larghe	Profili U ad ali parallele	Profili U ad ali inclinate

406	UB 406x140/178					
430						
457	UB 457x152/191					
533	UB 533x210					
610	UB 610x229/305					
686	UB 686x254					
762	UB 762x267					
838	UB 838x292					
914	UB 914x305/419					
1016	UB 1016x305					
					PFC 430x100	CH 432x102

* Tonelaje mínimo y condiciones de suministro previo acuerdo.

* Minimum tonnage and delivery conditions upon agreement.

* Tonnellaggio minimo e condizioni di fornitura da concordare.

Gamas de perfiles americanos*





Dimensiones nominales: altura en mm (pulgadas)

American section ranges*

Nominal sizes: depth in mm (inch)

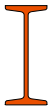
Gamma dei profili americani*

Dimensioni nominali: altezza in mm (pollici)

						
	W	S	HP	C	MC	L
	páginas/pages/pagine 116-133	páginas/pages/pagine 134-135	páginas/pages/pagine 136-137	páginas/pages/pagine 138-139	páginas/pages/pagine 140-143	páginas/pages/pagine 144-152
Altura mm / in	Perfiles de alas paralelas	Perfiles I de alas inclinadas	Perfiles H de alas anchas para pilotes	Perfiles U estándar de alas inclinadas	Perfiles U de alas inclinadas	Perfiles angulares de lados iguales
Depth mm / in	Wide flange beams	Standard Beams	Wide flange bearing piles	Standard channels	MC channels	Equal leg angles
Altezza mm / in	Profili I ad ali parallele	Profili I ad ali inclinate	Profili H ad ali larghe	Profili U standard ad ali inclinate	Profili U ad ali inclinate	Angolari ad ali uguali
	metric imperial	metric imperial	metric imperial	metric imperial	metric imperial	metric imperial

19 / ¾						L 19	L ¾	
25 / 1						L 25	L 1	
32 / 1 ¼						L 32	L 1 ¼	
38 / 1 ½						L 38	L 1 ½	
44 / 1 ¾						L 44	L 1 ¾	
51 / 2						L 51	L 2	
64 / 2 ½						L 64	L 2 ½	
75 / 3		S 75	S 3		C 75	C 3	L 76	L 3
89 / 3 ½							L 89	L 3 ½
100 / 4	W 100	W 4	S 100	S 4	C 100	C 4	L 102	L 4
130 / 5	W 130	W 5	S 130	S 5	C 130	C 5	L 127	L 5
150 / 6	W 150	W 6	S 150	S 6	C 150	C 6	L 152	L 6
180 / 7					C 180	C 7	MC 150	MC 6
200 / 8	W 200	W 8	S 200	S 8	HP 200	HP 8	C 200	C 8
230 / 9							MC 180	MC 7
250 / 10	W 250	W 10	S 250	S 10	HP 250	HP 10	C 230	C 9
310 / 12	W 310	W 12	S 310	S 12	HP 310	HP 12	C 250	C 10
330 / 13							C 310	C 12
360 / 14	W 360	W 14			HP 360	HP 14	MC 310	MC 12
380 / 15			S 380	S 15			MC 330	MC 13
410 / 16	W 410	W 16						
460 / 18	W 460	W 18	S 460	S 18			MC 460	MC 18
510 / 20			S 510	S 20				
530 / 21	W 530	W 21						
610 / 24	W 610	W 24	S 610	S 24				
690 / 27	W 690	W 27						
760 / 30	W 760	W 30						
840 / 33	W 840	W 33						
920 / 36	W 920	W 36						
1000 / 40	W 1000	W 40						
1100 / 44	W 1100	W 44						

* Tonelaje mínimo y condiciones de suministro previo acuerdo.

* Minimum tonnage and delivery conditions upon agreement.

* Tonnellaggio minimo e condizioni di fornitura da concordare.

Gamas de perfiles japoneses*

Dimensiones nominales: altura x ancho en mm

Japanese section ranges*

Nominal sizes: depth x width in mm

Gamma dei profili giapponesi*

Dimensioni nominali: altezza x larghezza in mm

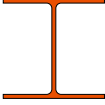
		
	H	H
	páginas/pages/pagine 154-157	páginas/pages/pagine 154-157
Altura	Perfiles	Perfiles de ala ancha para pilotes
Depth	Beams	Wide flange bearing piles
Altezza	Profili	Profili portanti ad ali larghe

100	H 100 x 100	
125	H 125 x 125	
150	H 150 x 75	
150	H 150 x 150	
175	H 175 x 175	
200	H 200 x 100	
200	H 200 x 150	
200	H 200 x 200	H 200 x 200
250	H 250 x 125	
250	H 250 x 250	H 250 x 250
300	H 300 x 150	
300	H 300 x 300	H 300 x 300
350	H 350 x 175	
350	H 350 x 350	H 350 x 350
400	H 400 x 200	
400	H 400 x 300	
400	H 400 x 400	H 400 x 400
500	H 500 x 200	
500	H 500 x 300	
600	H 600 x 300	
700	H 700 x 300	
800	H 800 x 300	
900	H 900 x 300	

* Tonelaje mínimo y condiciones de suministro previo acuerdo.

* Minimum tonnage and delivery conditions upon agreement.

* Tonnellaggio minimo e condizioni di fornitura da concordare.

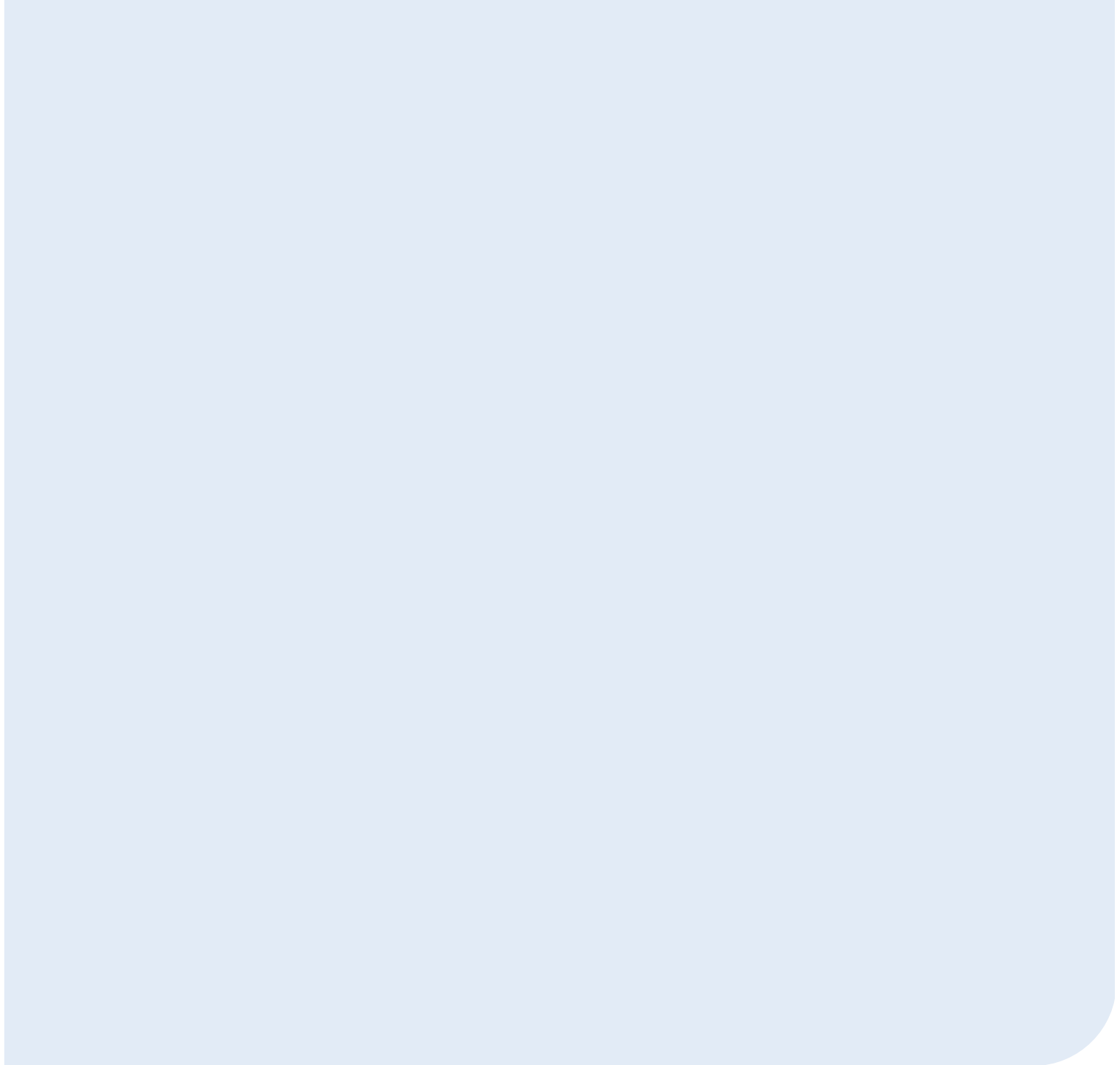

Perfiles europeos y comerciales

- 16 IPE Perfiles I de alas paralelas
- 22 IPN Perfiles I de alas inclinadas
- 24 HE Perfiles H de alas anchas
- 32 HL Perfiles H de alas muy anchas
- 36 HD Perfiles H de alas anchas para pilares
- 40 HP Perfiles H de alas anchas para pilotes
- 44 UPE Perfiles U de alas paralelas
- 46 UPN Perfiles U de alas inclinadas
- 48 U Perfiles U comerciales de alas inclinadas
- 50 UE Perfiles U comerciales de alas inclinadas
- 52 L Perfiles angulares de lados iguales
- 64 L Perfiles angulares de lados desiguales
- 70 Pletinas y llantas estrechas + pletinas y llantas
- 71 Barras cuadradas
- 72 Barras redondas de acero laminadas en caliente
- 73 Perfil en T de alas iguales

European sections and merchant bars

- 16 IPE European I beams
- 22 IPN European standard beams
- 24 HE European wide flange beams
- 32 HL European extra wide flange beams
- 36 HD Wide flange columns
- 40 HP Wide flange bearing piles
- 44 UPE Channels with parallel flanges
- 46 UPN European standard channels
- 48 U Channels with taper flanges
- 50 UE Channels with taper flanges
- 52 L Equal leg angles
- 64 L Unequal leg angles
- 70 Narrow flat bars + Flat bars
- 71 Square bars
- 72 Hot rolled round steel bars
- 73 Equal flange tees

Profili europei e laminati mercantili

- 16 IPE Profili I ad ali parallele
- 22 IPN Profili I ad ali inclinate
- 24 HE Profili H ad ali larghe
- 32 HL Profili H ad ali extra larghe
- 36 HD Profili H portanti a spessore maggiorato
- 40 HP Profili H portanti ad ali extra larghe
- 44 UPE Profili U ad ali parallele
- 46 UPN Profili U ad ali inclinate
- 48 U Profili U ad ali inclinate
- 50 UE Profili U ad ali inclinate
- 52 L Angolari a lati uguali
- 64 L Angolari a lati diseguali
- 70 Piatti e larghi piatti
- 71 Quadri
- 72 Tondi laminati a caldo
- 73 Profili T ad ali uguali



Perfiles I de alas paralelas

Dimensiones: IPE 80 - 600 conforme a la norma anterior EU 19-57
IPE AA 80 - 550, IPE A 80 - 600, IPE O 180 - 600, IPE 750 conforme a la norma de fábrica
Tolerancias: EN 10034: 1993
Estado de la superficie: conforme a EN 10163-3: 2004, clase C, subclase 1

European I beams

Dimensions: IPE 80 - 600 in accordance with former standard EU 19-57
IPE AA 80 - 550, IPE A 80 - 600, IPE O 180 - 600, IPE 750 in accordance with mill standard
Tolerances: EN 10034: 1993
Surface condition: according to EN 10163-3: 2004, class C, subclass 1

Profili I ad ali paralele

Dimensioni: IPE 80 - 600 secondo il vecchio standard EU 19-57
IPE AA 80 - 550, IPE A 80 - 600, IPE O 180 - 600, IPE 750 secondo lo standard dell'acciaieria
Tolleranze: EN 10034: 1993
Condizioni di superficie: secondo EN 10163-3: 2004, classe C, sottoclasse 1

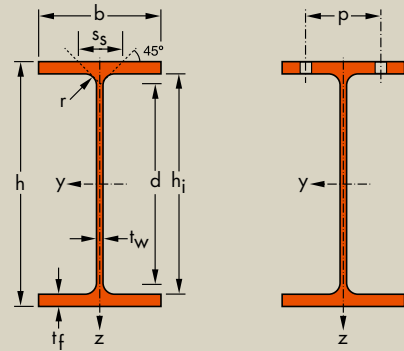

Denominación Designation Designazione	Dimensiones Dimensions Dimensioni						A mm ² x10 ²	Dimensiones de construcción Dimensions for detailing Dimensioni di dettaglio					Superficie Surface Superficie	
	G kg/m	h mm	b mm	t _w mm	t _r mm	r mm		h _i mm	d mm	Ø	p _{min} mm	p _{max} mm	A _L m ² /m	A _G m ² /t
IPE AA 80*	4,9	78	46	3,2	4,2	5,0	6,31	69,6	59,6	-	-	-	0,325	65,62
IPE A 80·/*	5,0	78	46	3,3	4,2	5,0	6,38	69,6	59,6	-	-	-	0,325	64,90
IPE 80*	6,0	80	46	3,8	5,2	5,0	7,64	69,6	59,6	-	-	-	0,328	54,64
IPE AA 100*	6,7	97,6	55	3,6	4,5	7,0	8,56	88,6	74,6	-	-	-	0,396	58,93
IPE A 100·/*	6,9	98	55	3,6	4,7	7,0	8,8	88,6	74,6	-	-	-	0,397	57,57
IPE 100*	8,1	100	55	4,1	5,7	7,0	10,3	88,6	74,6	-	-	-	0,400	49,33
IPE AA 120*	8,4	117	64	3,8	4,8	7,0	10,7	107,4	93,4	-	-	-	0,470	56,26
IPE A 120·	8,7	117,6	64	3,8	5,1	7,0	11,0	107,4	93,4	-	-	-	0,472	54,47
IPE 120	10,4	120	64	4,4	6,3	7,0	13,2	107,4	93,4	-	-	-	0,475	45,82
IPE AA 140*	10,1	136,6	73	3,8	5,2	7,0	12,8	126,2	112,2	-	-	-	0,546	54,26
IPE A 140·	10,5	137,4	73	3,8	5,6	7,0	13,4	126,2	112,2	-	-	-	0,547	52,05
IPE 140	12,9	140	73	4,7	6,9	7,0	16,4	126,2	112,2	-	-	-	0,551	42,70
IPE AA 160*	12,1	156,4	82	4,0	5,6	7,0	15,4	145,2	131,2	-	-	-	0,621	50,40
IPE A 160·	12,7	157	82	4,0	5,9	9,0	16,2	145,2	127,2	-	-	-	0,619	48,70
IPE 160	15,8	160	82	5,0	7,4	9,0	20,1	145,2	127,2	-	-	-	0,623	39,47
IPE AA 180*	14,9	176,4	91	4,3	6,2	9,0	19,0	164,0	146,0	M 10	48	48	0,693	46,37
IPE A 180·	15,4	177	91	4,3	6,5	9,0	19,6	164,0	146,0	M 10	48	48	0,694	45,15
IPE 180	18,8	180	91	5,3	8,0	9,0	23,9	164,0	146,0	M 10	48	48	0,698	37,13
IPE O 180+	21,3	182	92	6,0	9,0	9,0	27,1	164,0	146,0	M 10	50	50	0,705	33,12
IPE AA 200*	18,0	196,4	100	4,5	6,7	12,0	22,9	183,0	159,0	M 10	54	58	0,763	42,51
IPE A 200·	18,4	197	100	4,5	7,0	12,0	23,5	183,0	159,0	M 10	54	58	0,764	41,49
IPE 200	22,4	200	100	5,6	8,5	12,0	28,5	183,0	159,0	M 10	54	58	0,768	34,36
IPE O 200+	25,1	202	102	6,2	9,5	12,0	32,0	183,0	159,0	M 10	56	60	0,779	31,05
IPE AA 220*	21,2	216,4	110	4,7	7,4	12,0	27,0	201,6	177,6	M 12	60	62	0,843	39,78
IPE A 220·	22,2	217	110	5,0	7,7	12,0	28,3	201,6	177,6	M 12	60	62	0,843	38,02
IPE 220	26,2	220	110	5,9	9,2	12,0	33,4	201,6	177,6	M 12	60	62	0,848	32,36
IPE O 220+	29,4	222	112	6,6	10,2	12,0	37,4	201,6	177,6	M 10	58	66	0,858	29,24

· Pedido mínimo: para calidad S235 JR véanse condiciones de suministro en pág. 216; para cualquier otra calidad 40 t o según acuerdo.

+ Pedido mínimo: 40 t por perfil y calidad o según acuerdo.

* Tonelaje mínimo y condiciones de suministro previo acuerdo.

· Minimum order: for the S235 JR grade cf. delivery conditions page 216; for any other grade 40t or upon agreement.

+ Minimum order: 40t per section and grade or upon agreement.

* Minimum tonnage and delivery conditions upon agreement.

· Ordine minimo: Per la qualità S235 JR vedere le condizioni di fornitura a pagina 216; per qualunque altra qualità: 40t o da concordare.

+ Ordine minimo: 40t per sezione e qualità o da concordare.

* Tonnellaggio minimo e condizioni di fornitura da concordare.

Páginas de notaciones 199-203 / Notations pages 199-203 / Pagine di annotazioni 199-203

Denominación Designation Designazione	Propiedades del perfil / Section properties / Proprietà geometriche del profilo												Classification EN 1993-1-1: 2005						EN 10025-2: 2004	EN 10025-4: 2004	EN 10225:2001	
	eje fuerte y-y strong axis y-y asse forte y-y						eje débil z-z weak axis z-z asse debole z-z						Pure bending y-y			Pure compression						
	G kg/m	I_y mm ⁴ x10 ⁴	W_{ely} mm ³ x10 ³	W_{ply} ♦ mm ³ x10 ³	i_y mm x10	A_z mm ² x10 ²	I_z mm ⁴ x10 ⁴	W_{elz} mm ³ x10 ³	W_{plz} ♦ mm ³ x10 ³	i_z mm x10	s_s mm	I_t mm ⁴ x10 ⁴	I_w mm ⁶ x10 ⁹	S235	S355	S460	S235	S355				S460
IPE AA 80	4,9	64,1	16,4	18,9	3,19	3,00	6,85	2,98	4,7	1,04	17,5	0,40	0,09	1	1	-	1	1	-	✓		
IPE A 80	5,0	64,4	16,5	19,0	3,18	3,07	6,85	2,98	4,7	1,04	17,6	0,42	0,09	1	1	-	1	1	-	✓		
IPE 80	6,0	80,1	20,0	23,2	3,24	3,58	8,49	3,69	5,8	1,05	20,1	0,70	0,12	1	1	-	1	1	-	✓		
IPE AA 100	6,7	136	27,9	31,9	3,98	4,40	12,6	4,57	7,2	1,21	20,8	0,73	0,27	1	1	-	1	1	-	✓		
IPE A 100	6,9	141	28,8	33,0	4,01	4,44	13,1	4,77	7,5	1,22	21,2	0,77	0,28	1	1	-	1	1	-	✓		
IPE 100	8,1	171	34,2	39,4	4,07	5,08	15,9	5,79	9,2	1,24	23,7	1,20	0,35	1	1	-	1	1	-	✓		
IPE AA 120	8,4	244	41,7	47,6	4,79	5,36	21,1	6,59	10,4	1,41	21,6	0,95	0,66	1	1	-	1	1	-	✓		
IPE A 120	8,7	257	43,8	49,9	4,83	5,41	22,4	7,00	11,0	1,42	22,2	1,04	0,71	1	1	-	1	1	-	✓		
IPE 120	10,4	318	53,0	60,7	4,90	6,31	27,7	8,65	13,6	1,45	25,2	1,74	0,89	1	1	-	1	1	-	✓		
IPE AA 140	10,1	407	59,7	67,6	5,64	6,14	33,8	9,27	14,5	1,63	22,4	1,19	1,46	1	1	-	1	2	-	✓		
IPE A 140	10,5	435	63,3	71,6	5,70	6,21	36,4	10,0	15,5	1,65	23,2	1,36	1,58	1	1	1	1	2	3	✓	✓	✓
IPE 140	12,9	541	77,3	88,3	5,74	7,64	44,9	12,3	19,3	1,65	26,7	2,45	1,98	1	1	1	1	1	2	✓	✓	✓
IPE AA 160	12,1	646	82,6	93,3	6,47	7,24	51,6	12,6	19,6	1,83	23,4	1,57	2,93	1	1	-	1	3	-	✓		
IPE A 160	12,7	689	87,8	99,1	6,53	7,80	54,4	13,3	20,7	1,83	26,3	1,96	3,09	1	1	1	1	3	4	✓	✓	✓
IPE 160	15,8	869	109	124	6,58	9,66	68,3	16,7	26,1	1,84	30,3	3,60	3,96	1	1	1	1	1	2	✓	✓	✓
IPE AA 180	14,9	1020	116	131	7,32	9,13	78,1	17,2	26,7	2,03	27,2	2,48	5,64	1	1	-	2	3	-	✓		
IPE A 180	15,4	1063	120	135	7,37	9,20	81,9	18,0	28,0	2,05	27,8	2,70	5,93	1	1	1	2	3	4	✓	✓	✓
IPE 180	18,8	1317	146	166	7,42	11,3	101	22,2	34,6	2,05	31,8	4,79	7,43	1	1	1	1	2	3	✓	✓	✓
IPE O 180	21,3	1505	165	189	7,45	12,7	117	25,5	39,9	2,08	34,5	6,76	8,74	1	1	1	1	1	2	✓	✓	✓
IPE AA 200	18,0	1533	156	176	8,19	11,4	112	22,4	35,0	2,21	32,0	3,84	10,1	1	1	-	2	4	-	✓		
IPE A 200	18,4	1591	162	182	8,23	11,5	117	23,4	36,5	2,23	32,6	4,11	10,5	1	1	1	2	4	4	✓	✓	✓
IPE 200	22,4	1943	194	221	8,26	14,0	142	28,5	44,6	2,24	36,7	6,98	13,0	1	1	1	1	2	3	✓	✓	✓
IPE O 200	25,1	2211	219	249	8,32	15,5	169	33,1	51,9	2,30	39,3	9,45	15,6	1	1	1	1	1	2	✓	✓	✓
IPE AA 220	21,2	2219	205	230	9,07	12,8	165	29,9	46,5	2,47	33,6	5,02	17,9	1	1	-	2	4	-	✓		
IPE A 220	22,2	2317	214	240	9,05	13,6	171	31,2	48,5	2,46	34,5	5,69	18,7	1	1	1	2	4	4	✓	✓	✓
IPE 220	26,2	2772	252	285	9,11	15,9	205	37,3	58,1	2,48	38,4	9,07	22,7	1	1	1	1	2	4	✓	✓	✓
IPE O 220	29,4	3134	282	321	9,16	17,7	240	42,8	66,9	2,53	41,1	12,3	26,8	1	1	1	1	2	2	✓	✓	✓

♦ W_{pl} : para el diseño plástico la sección debe pertenecer a la clase 1 o 2 según la capacidad de rotación que se precise. Véase pág. 203.
 ♦ W_{pl} : for plastic design, the shape must belong to class 1 or 2 according to the required rotation capacity. See page 203.
 ♦ W_{pl} : per il calcolo plastico, la sezione trasversale deve appartenere alla classe 1 o 2, conformemente alla capacità di rotazione richiesta. Vedere pagina 203.

Perfiles I de alas paralelas (continúa)

Dimensiones: IPE 80 - 600 conforme a la norma anterior EU 19-57
 IPE AA 80 - 550, IPE A 80 - 600, IPE O 180 - 600, IPE 750 conforme a la norma de fábrica
 Tolerancias: EN 10034: 1993
 Estado de la superficie: conforme a EN 10163-3: 2004, clase C, subclase 1

European I beams (continued)

Dimensions: IPE 80 - 600 in accordance with former standard EU 19-57
 IPE AA 80 - 550, IPE A 80 - 600, IPE O 180 - 600, IPE 750 in accordance with mill standard
 Tolerances: EN 10034: 1993
 Surface condition: according to EN 10163-3: 2004, class C, subclass 1

Profili I ad ali paralele (continua)

Dimensioni: IPE 80 - 600 secondo il vecchio standard EU 19-57
 IPE AA 80 - 550, IPE A 80 - 600, IPE O 180 - 600, IPE 750 secondo lo standard dell'acciaieria
 Tolleranze: EN 10034: 1993
 Condizioni di superficie: secondo EN 10163-3: 2004, classe C, sottoclasse 1

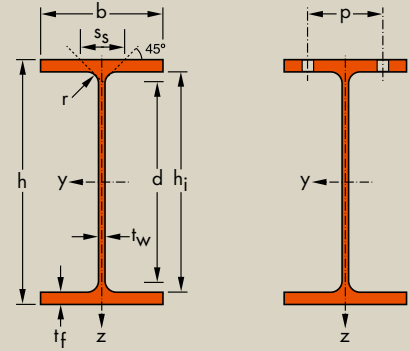

Denominación Designation Designazione	Dimensiones Dimensions Dimensioni						A mm ² x10 ²	Dimensiones de construcción Dimensions for detailing Dimensioni di dettaglio					Superficie Surface Superficie	
	G kg/m	h mm	b mm	t _w mm	t _f mm	r mm		h _i mm	d mm	Ø mm	p _{min} mm	p _{max} mm	A _L m ² /m	A _C m ² /t
IPE AA 240*	24,9	236,4	120	4,8	8,0	15,0	31,7	220,4	190,4	M 12	64	68	0,917	36,86
IPE A 240·	26,2	237	120	5,2	8,3	15,0	33,3	220,4	190,4	M 12	64	68	0,918	35,10
IPE 240	30,7	240	120	6,2	9,8	15,0	39,1	220,4	190,4	M 12	66	68	0,922	30,02
IPE O 240+	34,3	242	122	7,0	10,8	15,0	43,7	220,4	190,4	M 12	66	70	0,932	27,17
IPE A 270·	30,7	267	135	5,5	8,7	15,0	39,2	249,6	219,6	M 16	70	72	1,037	33,75
IPE 270	36,1	270	135	6,6	10,2	15,0	45,9	249,6	219,6	M 16	72	72	1,041	28,86
IPE O 270+	42,3	274	136	7,5	12,2	15,0	53,8	249,6	219,6	M 16	72	72	1,051	24,88
IPE A 300·	36,5	297	150	6,1	9,2	15,0	46,5	278,6	248,6	M 16	72	86	1,156	31,65
IPE 300	42,2	300	150	7,1	10,7	15,0	53,8	278,6	248,6	M 16	72	86	1,160	27,46
IPE O 300+	49,3	304	152	8,0	12,7	15,0	62,8	278,6	248,6	M 16	74	88	1,174	23,81
IPE A 330·	43,0	327	160	6,5	10,0	18,0	54,7	307,0	271,0	M 16	78	96	1,250	29,09
IPE 330	49,1	330	160	7,5	11,5	18,0	62,6	307,0	271,0	M 16	78	96	1,254	25,52
IPE O 330+	57,0	334	162	8,5	13,5	18,0	72,6	307,0	271,0	M 16	80	98	1,268	22,24
IPE A 360·	50,2	357,6	170	6,6	11,5	18,0	64,0	334,6	298,6	M 22	86	88	1,351	26,91
IPE 360	57,1	360	170	8,0	12,7	18,0	72,7	334,6	298,6	M 22	88	88	1,353	23,70
IPE O 360+	66,0	364	172	9,2	14,7	18,0	84,1	334,6	298,6	M 22	90	90	1,367	20,69
IPE A 400·	57,4	397	180	7,0	12,0	21,0	73,1	373,0	331,0	M 22	94	98	1,464	25,51
IPE 400	66,3	400	180	8,6	13,5	21,0	84,5	373,0	331,0	M 22	96	98	1,467	22,12
IPE O 400+	75,7	404	182	9,7	15,5	21,0	96,4	373,0	331,0	M 22	96	100	1,481	19,57
IPE A 450·	67,2	447	190	7,6	13,1	21,0	85,6	420,8	378,8	M 24	100	102	1,603	23,87
IPE 450	77,6	450	190	9,4	14,6	21,0	98,8	420,8	378,8	M 24	100	102	1,605	20,69
IPE O 450+	92,4	456	192	11,0	17,6	21,0	118	420,8	378,8	M 24	102	104	1,622	17,56
IPE A 500·	79,4	497	200	8,4	14,5	21,0	101	468,0	426,0	M 24	100	112	1,741	21,94
IPE 500	90,7	500	200	10,2	16,0	21,0	116	468,0	426,0	M 24	102	112	1,744	19,23
IPE O 500+	107	506	202	12,0	19,0	21,0	137	468,0	426,0	M 24	104	114	1,76	16,4

· Pedido mínimo: para calidad S235 JR véanse condiciones de suministro en pág. 216; para cualquier otra calidad 40 t o según acuerdo.

+ Pedido mínimo: 40 t por perfil y calidad o según acuerdo.

* Tonelaje mínimo y condiciones de suministro previo acuerdo.

· Minimum order: for the S235 JR grade cf. delivery conditions page 216; for any other grade 40t or upon agreement.

+ Minimum order: 40t per section and grade or upon agreement.

* Minimum tonnage and delivery conditions upon agreement.

· Ordine minimo: Per la qualità S235 JR vedere le condizioni di fornitura a pagina 216; per qualunque altra qualità: 40t o da concordare.

+ Ordine minimo: 40t per sezione e qualità o da concordare.

* Tonnellaggio minimo e condizioni di fornitura da concordare.

Páginas de notaciones 199-203 / Notations pages 199-203 / Pagine di annotazioni 199-203

Denominación Designation Designazione	Propiedades del perfil / Section properties / Proprietà geometriche del profilo													Classification EN 1993-1-1: 2005						EN 10025-2: 2004	EN 10025-4: 2004	EN 10225:2001
	eje fuerte y-y strong axis y-y asse forte y-y						eje débil z-z weak axis z-z asse debole z-z				Pure bending y-y			Pure compression								
	G kg/m	I_y mm ⁴ x10 ⁴	$W_{el,y}$ mm ³ x10 ³	$W_{pl,y} \blacklozenge$ mm ³ x10 ³	i_y mm x10	A_z mm ² x10 ²	I_z mm ⁴ x10 ⁴	$W_{el,z}$ mm ³ x10 ³	$W_{pl,z} \blacklozenge$ mm ³ x10 ³	i_z mm x10	s_s mm	I_t mm ⁴ x10 ⁴	I_w mm ⁶ x10 ⁹	S235	S355	S460	S235	S355	S460			
IPE AA 240	24,9	3154	267	298	9,97	15,3	231	38,6	60,0	2,70	38,4	7,33	30,1	1	1	-	3	4	-	✓	✓	✓
IPE A 240	26,2	3290	278	312	9,94	16,3	240	40,0	62,4	2,68	39,4	8,35	31,3	1	1	1	2	4	4	✓	✓	✓
IPE 240	30,7	3892	324	367	9,97	19,1	284	47,3	73,9	2,69	43,4	12,9	37,4	1	1	1	1	2	4	✓	✓	✓
IPE O 240	34,3	4369	361	410	10,0	21,4	329	53,9	84,4	2,74	46,2	17,2	43,7	1	1	1	1	2	3	✓	✓	✓
IPE A 270	30,7	4917	368	413	11,2	18,8	358	53,0	82,3	3,02	40,5	10,3	59,5	1	1	1	3	4	4	✓	✓	✓
IPE 270	36,1	5790	429	484	11,2	22,1	420	62,2	97,0	3,02	44,6	15,9	70,6	1	1	1	2	3	4	✓	✓	✓
IPE O 270	42,3	6947	507	575	11,4	25,2	514	75,5	118	3,09	49,5	24,9	87,6	1	1	1	1	2	3	✓	✓	✓
IPE A 300	36,5	7173	483	542	12,4	22,3	519	69,2	107	3,34	42,1	13,4	107	1	1	1	3	4	4	✓	✓	✓
IPE 300	42,2	8356	557	628	12,5	25,7	604	80,5	125	3,35	46,1	20,1	126	1	1	1	2	4	4	✓	✓	✓
IPE O 300	49,3	9994	658	744	12,6	29,1	746	98,1	153	3,45	51,0	31,1	158	1	1	1	1	3	4	✓	✓	✓
IPE A 330	43	10230	626	702	13,7	27,0	685	85,6	133	3,54	47,6	19,6	172	1	1	1	3	4	4	✓	✓	✓
IPE 330	49,1	11770	713	804	13,7	30,8	788	98,5	154	3,55	51,6	28,2	199	1	1	1	2	4	4	✓	✓	✓
IPE O 330	57	13910	833	943	13,8	34,9	960	119	185	3,64	56,6	42,2	246	1	1	1	1	3	4	✓	✓	✓
IPE A 360	50,2	14520	812	907	15,1	29,8	944	111	172	3,84	50,7	26,5	282	1	1	1	4	4	4	✓	✓	✓
IPE 360	57,1	16270	904	1019	15,0	35,1	1043	123	191	3,79	54,5	37,3	314	1	1	1	2	4	4	✓	✓	✓
IPE O 360	66	19050	1047	1186	15,1	40,2	1251	146	227	3,86	59,7	55,8	380	1	1	1	1	3	4	✓	✓	✓
IPE A 400	57,4	20290	1022	1144	16,7	35,8	1171	130	202	4,00	55,6	34,8	432	1	1	1	4	4	4	✓	✓	✓
IPE 400	66,3	23130	1160	1307	16,6	42,7	1318	146	229	3,95	60,2	51,1	490	1	1	1	3	4	4	✓	✓	✓
IPE O 400	75,7	26750	1324	1502	16,7	48,0	1564	172	269	4,03	65,3	73,1	588	1	1	1	2	3	4	✓	✓	✓
IPE A 450	67,2	29760	1331	1494	18,7	42,3	1502	158	246	4,19	58,4	45,7	705	1	1	1	4	4	4	✓	✓	✓
IPE 450	77,6	33740	1500	1702	18,5	50,9	1676	176	276	4,12	63,2	66,9	791	1	1	1	3	4	4	✓	✓	✓
IPE O 450	92,4	40920	1795	2046	18,7	59,4	2085	217	341	4,21	70,8	109	998	1	1	1	2	4	4	✓	✓	✓
IPE A 500	79,4	42930	1728	1946	20,6	50,4	1939	194	302	4,38	62,0	62,8	1125	1	1	1	4	4	4	✓	✓	✓
IPE 500	90,7	48200	1930	2194	20,4	59,9	2142	214	336	4,31	66,8	89,3	1249	1	1	1	3	4	4	✓	✓	✓
IPE O 500	107	57780	2284	2613	20,6	70,2	2622	260	409	4,38	74,6	144	1548	1	1	1	2	4	4	✓	✓	✓

◆ W_{pl} : para el diseño plástico la sección debe pertenecer a la clase 1 o 2 según la capacidad de rotación que se precise. Véase pág. 203.

◆ W_{pl} : for plastic design, the shape must belong to class 1 or 2 according to the required rotation capacity. See page 203.

◆ W_{pl} : per il calcolo plastico, la sezione trasversale deve appartenere alla classe 1 o 2, conformemente alla capacità di rotazione richiesta. Vedere pagina 203.

Perfiles I de alas paralelas (continúa)

Dimensiones: IPE 80 - 600 conforme a la norma anterior EU 19-57
 IPE AA 80 - 550, IPE A 80 - 600, IPE O 180 - 600, IPE 750 conforme a la norma de fábrica
 Tolerancias: EN 10034: 1993
 Estado de la superficie: conforme a EN 10163-3: 2004, clase C, subclase 1

European I beams (continued)

Dimensions: IPE 80 - 600 in accordance with former standard EU 19-57
 IPE AA 80 - 550, IPE A 80 - 600, IPE O 180 - 600, IPE 750 in accordance with mill standard
 Tolerances: EN 10034: 1993
 Surface condition: according to EN 10163-3: 2004, class C, subclass 1

Profili I ad ali paralele (continua)

Dimensioni: IPE 80 - 600 secondo il vecchio standard EU 19-57
 IPE AA 80 - 550, IPE A 80 - 600, IPE O 180 - 600, IPE 750 secondo lo standard dell'acciaieria
 Tolleranze: EN 10034: 1993
 Condizioni di superficie: secondo EN 10163-3: 2004, classe C, sottoclasse 1

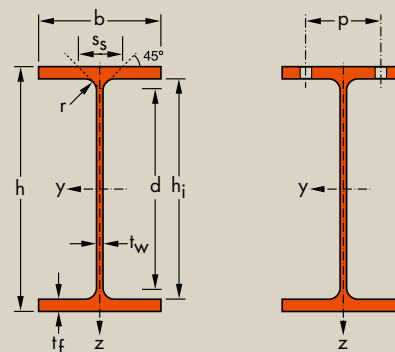

Denominación Designation Designazione	Dimensiones Dimensions Dimensioni						A mm ² x10 ²	Dimensiones de construcción Dimensions for detailing Dimensioni di dettaglio					Superficie Surface Superficie	
	G kg/m	h mm	b mm	t _w mm	t _f mm	r mm		h _i mm	d mm	Ø mm	p _{min} mm	p _{max} mm	A _L m ² /m	A _G m ² /t
IPE A 550•	92,1	547	210	9,0	15,7	24,0	117	515,6	467,6	M 24	106	122	1,875	20,36
IPE 550	106	550	210	11,1	17,2	24,0	134	515,6	467,6	M 24	110	122	1,877	17,78
IPE O 550+	123	556	212	12,7	20,2	24,0	156	515,6	467,6	M 24	110	122	1,893	15,45
IPE A 600•	108	597	220	9,8	17,5	24,0	137	562,0	514,0	M 27	114	118	2,013	18,72
IPE 600	122	600	220	12,0	19,0	24,0	156	562,0	514,0	M 27	116	118	2,015	16,45
IPE O 600+	154	610	224	15,0	24,0	24,0	197	562,0	514,0	M 27	118	122	2,045	13,24
IPE 750 x 137*	137	753	263	11,5	17,0	17,0	175	719,0	685,0	M 27	102	162	2,506	18,28
IPE 750 x 147	147	753	265	13,2	17,0	17,0	188	719,0	685,0	M 27	104	164	2,51	17,06
IPE 750 x 173+	173	762	267	14,4	21,6	17,0	221	718,8	684,8	M 27	104	166	2,534	14,58
IPE 750 x 196+	196	770	268	15,6	25,4	17,0	251	719,2	685,2	M 27	106	166	2,552	12,96

• Pedido mínimo: para calidad S235 JR véanse condiciones de suministro en pág. 216; para cualquier otra calidad 40 t o según acuerdo.

+ Pedido mínimo: 40 t por perfil y calidad o según acuerdo.

* Tonelaje mínimo y condiciones de suministro previo acuerdo.

• Minimum order: for the S235 JR grade cf. delivery conditions page 216; for any other grade 40t or upon agreement.

+ Minimum order: 40t per section and grade or upon agreement.

* Minimum tonnage and delivery conditions upon agreement.

• Ordine minimo: Per la qualità S235 JR vedere le condizioni di fornitura a pagina 216; per qualunque altra qualità: 40t o da concordare.

+ Ordine minimo: 40t per sezione e qualità o da concordare.

* Tonnellaggio minimo e condizioni di fornitura da concordare.

Páginas de notaciones 199-203 / Notations pages 199-203 / Pagine di annotazioni 199-203

Denominación Designation Designazione	Propiedades del perfil / Section properties / Proprietà geometriche del profilo													Classification EN 1993-1-1: 2005						EN 10025-2: 2004	EN 10025-4: 2004	EN 10225:2001
	eje fuerte y-y strong axis y-y asse forte y-y						eje débil z-z weak axis z-z asse debole z-z					Pure bending y-y			Pure compression							
	G	I_y	$W_{el,y}$	$W_{pl,y} \blacklozenge$	i_y	A_z	I_z	$W_{el,z}$	$W_{pl,z} \blacklozenge$	i_z	s_s	I_t	I_w	S235	S355	S460	S235	S355	S460			
kg/m	mm ⁴ x10 ⁴	mm ³ x10 ³	mm ³ x10 ³	mm x10	mm ² x10 ²	mm ⁴ x10 ⁴	mm ³ x10 ³	mm ³ x10 ³	mm x10	mm	mm ⁴ x10 ⁴	mm ⁶ x10 ⁹										
IPE A 550	92,1	59980	2193	2475	22,6	60,3	2432	232	362	4,55	68,5	86,5	1710	1	1	2	4	4	4	✓	✓	✓
IPE 550	106	67120	2440	2787	22,4	72,3	2668	254	401	4,45	73,6	123	1884	1	1	1	4	4	4	✓	HI	HI
IPE O 550	123	79160	2847	3263	22,5	82,7	3224	304	481	4,55	81,2	188	2302	1	1	1	2	4	4	✓	HI	HI
IPE A 600	108	82920	2778	3141	24,6	70,1	3116	283	442	4,77	72,9	119	2607	1	1	2	4	4	4	✓	✓	✓
IPE 600	122	92080	3070	3512	24,3	83,8	3387	308	486	4,66	78,1	165	2846	1	1	1	4	4	4	✓	HI	HI
IPE O 600	154	118300	3879	4471	24,5	104	4521	404	640	4,79	91,1	318	3860	1	1	1	2	4	4	✓	HI	HI
IPE 750 x 137	137	159900	4246	4865	30,3	92,9	5166	393	614	5,44	65,4	137	6980	1	2	-	4	4	-	✓	✓	✓
IPE 750 x 147	147	166100	4411	5110	29,8	105	5289	399	631	5,31	67,1	162	7141	1	1	2	4	4	4	✓	✓	✓
IPE 750 x 173	173	205800	5402	6218	30,5	116	6873	515	810	5,57	77,5	274	9391	1	1	1	4	4	4	✓	HI	HI
IPE 750 x 196	196	240300	6241	7174	31,0	127	8175	610	959	5,71	86,3	409	11290	1	1	1	4	4	4	✓	HI	HI

HI = HISTAR®

\blacklozenge W_{pl} : para el diseño plástico la sección debe pertenecer a la clase 1 o 2 según la capacidad de rotación que se precise. Véase pág. 203.
 \blacklozenge W_{pl} : for plastic design, the shape must belong to class 1 or 2 according to the required rotation capacity. See page 203.
 \blacklozenge W_{pl} : per il calcolo plastico, la sezione trasversale deve appartenere alla classe 1 o 2, conformemente alla capacità di rotazione richiesta. Vedere pagina 203.

Perfiles I de alas inclinadas

Inclinación de las alas: 14%
 Dimensiones: IPN 80 - IPN 550 DIN 1025-1: 1995, NF A 45-209: 1983
 IPN 600 DIN 1025-1: 1963
 Tolerancias: EN 10024: 1995
 Estado de la superficie: conforme a norma EN 10163-3: 2004, clase C, subclase 1

European standard beams

Flange slope: 14%
 Dimensions: IPN 80 - IPN 550 DIN 1025-1: 1995, NF A 45-209: 1983
 IPN 600 DIN 1025-1: 1963
 Tolerances: EN 10024: 1995
 Surface condition: according to EN 10163-3: 2004, class C, subclass 1

Profili I ad ali inclinate

Inclinazione dell'ala: 14%
 Dimensioni: IPN 80 - IPN 550 DIN 1025-1: 1995, NF A 45-209: 1983
 IPN 600 DIN 1025-1: 1963
 Tolleranze: EN 10024: 1995
 Condizioni di superficie: secondo EN 10163-3: 2004, classe C, sottoclasse 1

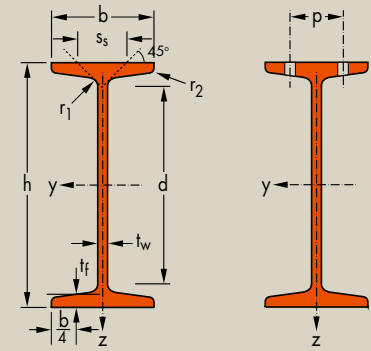

Denominación Designation Designazione	Dimensiones Dimensions Dimensioni							A mm ² x10 ²	Dimensiones de construcción Dimensions for detailing Dimensioni di dettaglio				Superficie Surface Superficie	
	G kg/m	h mm	b mm	tw mm	tf mm	r1 mm	r2 mm		d mm	Ø	p _{min} mm	p _{max} mm	Ac m ² /m	Ac m ² /t
IPN 80*	5,94	80	42	3,9	5,9	3,9	2,3	7,57	59	-	-	-	0,304	51,09
IPN 100*	8,34	100	50	4,5	6,8	4,5	2,7	10,6	75,7	-	-	-	0,370	44,47
IPN 120*	11,1	120	58	5,1	7,7	5,1	3,1	14,2	92,4	-	-	-	0,439	39,38
IPN 140*	14,3	140	66	5,7	8,6	5,7	3,4	18,2	109,1	-	-	-	0,502	34,94
IPN 160*	17,9	160	74	6,3	9,5	6,3	3,8	22,8	125,8	-	-	-	0,575	32,13
IPN 180*	21,9	180	82	6,9	10,4	6,9	4,1	27,9	142,4	-	-	-	0,640	29,22
IPN 200*	26,2	200	90	7,5	11,3	7,5	4,5	33,4	159,1	-	-	-	0,709	27,04
IPN 220*	31,1	220	98	8,1	12,2	8,1	4,9	39,5	175,8	M 10	50	56	0,775	24,99
IPN 240*	36,2	240	106	8,7	13,1	8,7	5,2	46,1	192,5	M 10	54	60	0,844	23,32
IPN 260*	41,9	260	113	9,4	14,1	9,4	5,6	53,3	208,9	M 12	62	62	0,906	21,65
IPN 280*	47,9	280	119	10,1	15,2	10,1	6,1	61,0	225,1	M 12	68	68	0,966	20,17
IPN 300*	54,2	300	125	10,8	16,2	10,8	6,5	69,0	241,6	M 12	70	74	1,03	19,02
IPN 320*	61,0	320	131	11,5	17,3	11,5	6,9	77,7	257,9	M 12	70	80	1,09	17,87
IPN 340*	68,0	340	137	12,2	18,3	12,2	7,3	86,7	274,3	M 12	78	86	1,15	16,90
IPN 360*	76,1	360	143	13	19,5	13	7,8	97,0	290,2	M 12	78	92	1,21	15,89
IPN 380*	84,0	380	149	13,7	20,5	13,7	8,2	107	306,7	M 16	84	86	1,27	15,12
IPN 400*	92,4	400	155	14,4	21,6	14,4	8,6	118	322,9	M 16	86	92	1,33	14,36
IPN 450*	115	450	170	16,2	24,3	16,2	9,7	147	363,6	M 16	92	106	1,48	12,83
IPN 500*	141	500	185	18	27	18	10,8	179	404,3	M 20	102	110	1,63	11,60
IPN 550*	166	550	200	19	30	19	11,9	212	445,6	M 22	112	118	1,80	10,80
IPN 600*	199	600	215	21,6	32,4	21,6	13	254	485,8	M 24	126	128	1,92	9,89

* Tonelaje mínimo y condiciones de suministro previo acuerdo.
 * Minimum tonnage and delivery conditions upon agreement.
 * Tonnellaggio minimo e condizioni di fornitura da concordare.

Páginas de notaciones 199-203 / Notations pages 199-203 / Pagine di annotazioni 199-203

Denominación Designation Designazione	Propiedades del perfil / Section properties / Proprietà geometriche del profilo												Classification EN 1993-1-1: 2005				EN 10025-2: 2004	EN 10025-4: 2004	EN 10225:2001	
	eje fuerte y-y strong axis y-y asse forte y-y						eje débil z-z weak axis z-z asse debole z-z				Pure bending y-y		Pure compression							
	G	I_y	$W_{el,y}$	W_{ply} ♦	i_y	A_{vz}	I_z	$W_{el,z}$	$W_{pl,z}$ ♦	i_z	s_s	I_t	I_w	S235	S355	S235				S355
kg/m	mm ⁴ x10 ⁴	mm ³ x10 ³	mm ³ x10 ³	mm x10	mm ² x10 ²	mm ⁴ x10 ⁴	mm ³ x10 ³	mm ³ x10 ³	mm x10	mm	mm ⁴ x10 ⁴	mm ⁶ x10 ⁹								
IPN 80	5,94	77,8	19,5	22,8	3,20	3,41	6,29	3,00	5,00	0,91	21,6	0,87	0,09	1	1	1	1	✓		
IPN 100	8,34	171	34,2	39,8	4,01	4,85	12,2	4,88	8,10	1,07	25,0	1,60	0,27	1	1	1	1	✓		
IPN 120	11,1	328	54,7	63,6	4,81	6,63	21,5	7,41	12,4	1,23	28,4	2,71	0,69	1	1	1	1	✓		
IPN 140	14,3	573	81,9	95,4	5,61	8,65	35,2	10,7	17,9	1,40	31,8	4,32	1,54	1	1	1	1	✓		
IPN 160	17,9	935	117	136	6,40	10,83	54,7	14,8	24,9	1,55	35,2	6,57	3,14	1	1	1	1	✓		
IPN 180	21,9	1450	161	187	7,20	13,35	81,3	19,8	33,2	1,71	38,6	9,58	5,92	1	1	1	1	✓		
IPN 200	26,2	2140	214	250	8,00	16,03	117	26,0	43,5	1,87	42,0	13,5	10,5	1	1	1	1	✓		
IPN 220	31,1	3060	278	324	8,80	19,06	162	33,1	55,7	2,02	45,4	18,6	17,8	1	1	1	1	✓		
IPN 240	36,2	4250	354	412	9,59	22,33	221	41,7	70,0	2,20	48,9	25,0	28,7	1	1	1	1	✓		
IPN 260	41,9	5740	442	514	10,40	26,08	288	51,0	85,9	2,32	52,6	33,5	44,1	1	1	1	1	✓		
IPN 280	47,9	7590	542	632	11,1	30,18	364	61,2	103	2,45	56,4	44,2	64,6	1	1	1	1	✓		
IPN 300	54,2	9800	653	762	11,9	34,58	451	72,2	121	2,56	60,1	56,8	91,8	1	1	1	1	✓		
IPN 320	61,0	12510	782	914	12,7	39,26	555	84,7	143	2,67	63,9	72,5	129	1	1	1	1	✓		
IPN 340	68,0	15700	923	1080	13,5	44,27	674	98,4	166	2,80	67,6	90,4	176	1	1	1	1	✓		
IPN 360	76,1	19610	1090	1276	14,2	49,95	818	114	194	2,90	71,8	115	240	1	1	1	1	✓		
IPN 380	84,0	24010	1260	1482	15,0	55,55	975	131	221	3,02	75,4	141	319	1	1	1	1	✓		
IPN 400	92,4	29210	1460	1714	15,7	61,69	1160	149	253	3,13	79,3	170	420	1	1	1	1	✓		
IPN 450	115	45850	2040	2400	17,7	77,79	1730	203	345	3,43	88,9	267	791	1	1	1	1	✓		
IPN 500	141	68740	2750	3240	19,6	95,60	2480	268	456	3,72	98,5	402	1400	1	1	1	1	✓		
IPN 550	166	99180	3610	4240	21,6	111,3	3490	349	592	4,02	107,3	544	2390	1	1	1	1	✓		
IPN 600	199	139000	4630	5452	23,4	138,0	4670	434	752	4,30	117,6	787	3814	1	1	1	1	✓		

♦ W_{pl} : para el diseño plástico la sección debe pertenecer a la clase 1 o 2 según la capacidad de rotación que se precise. Véase pág. 203.

♦ W_{pl} : for plastic design, the shape must belong to class 1 or 2 according to the required rotation capacity. See page 203.

♦ W_{pl} : per il calcolo plastico, la sezione trasversale deve appartenere alla classe 1 o 2, conformemente alla capacità di rotazione richiesta. Vedere pagina 203.

Perfiles H de alas anchas

Dim.: HE A, HE B y HE M 100 - 1000 conforme a la norma anterior EU 53-62; HE 1000 con $G_{HE} > G_{HEM}$ conforme a ASTM A 6/A 6M - 07
 HE C conforme a PN-H-93452: 2005; HE AA 100-1000 conforme a la norma de fábrica
 Tolerancias: EN 10034: 1993 HE 100 - 900; HE 1000 AA-M
 ASTM A 6/A 6M - 07 HE 1000 with $G_{HE} > G_{HEM}$

Estado de la superficie: conforme a norma EN 10163-3: 2004, clase C, subclase 1

European wide flange beams

Dim.: HE A, HE B and HE M 100 - 1000 in accordance with former standard EU 53-62; HE 1000 with $G_{HE} > G_{HEM}$ in accordance with ASTM A 6/A 6M - 07
 HE C in accordance with PN-H-93452: 2005; HE AA 100-1000 in accordance with mill standard
 Tolerances: EN 10034: 1993 HE 100 - 900; HE 1000 AA-M
 ASTM A 6/A 6M - 07 HE 1000 with $G_{HE} > G_{HEM}$

Surface condition: according to EN 10163-3: 2004, class C, subclass 1

Profili H ad ali larghe

Dim.: HE A, HE B and HE M 100 - 1000 secondo il vecchio standard EU 53-62; HE 1000 con $G_{HE} > G_{HEM}$ secondo ASTM A 6/A 6M - 07
 HE C secondo PN-H-93452: 2005; HE AA 100-1000 secondo lo standard dell'acciaieria
 Tolleranze: EN 10034: 1993 HE 100 - 900; HE 1000 AA-M
 ASTM A 6/A 6M - 07 HE 1000 con $G_{HE} > G_{HEM}$

Condizioni di superficie: secondo EN 10163-3: 2004, classe C, sottoclasse 1

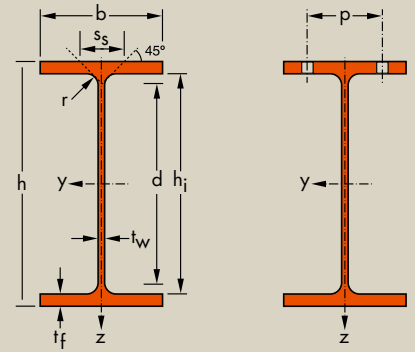

Denominación Designation Designazione	Dimensiones Dimensions Dimensioni						A mm ² x10 ²	Dimensiones de construcción Dimensions for detailing Dimensioni di dettaglio					Superficie Surface Superficie	
	G kg/m	h mm	b mm	t _w mm	t _r mm	r mm		h _i mm	d mm	Ø mm	p _{min} mm	p _{max} mm	A _L m ² /m	A _G m ² /t
HE 100 AA*	12,2	91	100	4,2	5,5	12	15,6	80	56	M 10	54	58	0,553	45,17
HE 100 A	16,7	96	100	5	8	12	21,2	80	56	M 10	54	58	0,561	33,68
HE 100 B	20,4	100	100	6	10	12	26,0	80	56	M 10	56	58	0,567	27,76
HE 100 C*	30,9	110	103	9	15	12	39,3	80	56	M 10	59	61	0,593	19,23
HE 100 M	41,8	120	106	12	20	12	53,2	80	56	M 10	62	64	0,619	14,82
HE 120 AA*	14,6	109	120	4,2	5,5	12	18,6	98	74	M 12	58	68	0,669	45,94
HE 120 A	19,9	114	120	5	8	12	25,3	98	74	M 12	58	68	0,677	34,06
HE 120 B	26,7	120	120	6,5	11	12	34,0	98	74	M 12	60	68	0,686	25,71
HE 120 C*	39,2	130	123	9,5	16	12	49,9	98	74	M 12	63	72	0,712	18,19
HE 120 M	52,1	140	126	12,5	21	12	66,4	98	74	M 12	66	74	0,738	14,16
HE 140 AA*	18,1	128	140	4,3	6	12	23,0	116	92	M 16	64	76	0,787	43,53
HE 140 A	24,7	133	140	5,5	8,5	12	31,4	116	92	M 16	64	76	0,794	32,21
HE 140 B	33,7	140	140	7	12	12	43,0	116	92	M 16	66	76	0,805	23,88
HE 140 C*	48,2	150	143	10	17	12	61,5	116	92	M 16	69	79	0,831	17,22
HE 140 M	63,2	160	146	13	22	12	80,6	116	92	M 16	72	82	0,857	13,56
HE 160 AA*	23,8	148	160	4,5	7	15	30,4	134	104	M 20	76	84	0,901	37,81
HE 160 A	30,4	152	160	6	9	15	38,8	134	104	M 20	78	84	0,906	29,78
HE 160 B	42,6	160	160	8	13	15	54,3	134	104	M 20	80	84	0,918	21,56
HE 160 C*	59,2	170	163	11	18	15	75,4	134	104	M 20	84	88	0,944	15,95
HE 160 M	76,2	180	166	14	23	15	97,1	134	104	M 20	86	90	0,970	12,74
HE 180 AA*	28,7	167	180	5	7,5	15	36,5	152	122	M 24	84	92	1,018	35,51
HE 180 A	35,5	171	180	6	9,5	15	45,3	152	122	M 24	86	92	1,024	28,83
HE 180 B	51,2	180	180	8,5	14	15	65,3	152	122	M 24	88	92	1,037	20,25
HE 180 C*	69,8	190	183	11,5	19	15	89,0	152	122	M 27	92	96	1,063	15,22
HE 180 M	88,9	200	186	14,5	24	15	113,3	152	122	M 24	94	98	1,089	12,25
HE 200 AA*	34,6	186	200	5,5	8	18	44,1	170	134	M 27	96	100	1,130	32,62
HE 200 A	42,3	190	200	6,5	10	18	53,8	170	134	M 27	98	100	1,136	26,89
HE 200 B	61,3	200	200	9	15	18	78,1	170	134	M 27	100	100	1,151	18,78
HE 200 C*	81,9	210	203	12	20	18	104,4	170	134	M 27	104	104	1,177	14,36
HE 200 M	103	220	206	15	25	18	131,3	170	134	M 27	106	106	1,203	11,67

· Pedido mínimo: para calidad S235 JR véase condiciones de suministro en pág. 216; para cualquier otra calidad 40 t o según acuerdo.
 * Tonelaje mínimo y condiciones de suministro previo acuerdo.

· Minimum order: for the S235 JR grade cf. delivery conditions page 216; for any other grade 40t or upon agreement.
 * Minimum tonnage and delivery conditions upon agreement.

· Ordine minimo: Per la qualità S235 JR vedere le condizioni di fornitura a pagina 216; per qualunque altra qualità: 40t o da concordare.
 * Tonnellaggio minimo e condizioni di fornitura da concordare.

Páginas de notaciones 199-203 / Notations pages 199-203 / Pagine di annotazioni 199-203

Denominación Designation Designazione	Propiedades del perfil / Section properties / Proprietà geometriche del profilo												Classification EN 1993-1-1: 2005						EN 10025-2: 2004	EN 10025-4: 2004	EN 10225:2001	
	eje fuerte y-y strong axis y-y asse forte y-y						eje débil z-z weak axis z-z asse debole z-z						Pure bending y-y			Pure compression						
	G kg/m	I _y mm ⁴ x10 ⁴	W _{ely} mm ³ x10 ³	W _{ply} ♦ mm ³ x10 ³	i _y mm x10	A _{vz} mm ² x10 ²	I _z mm ⁴ x10 ⁴	W _{elz} mm ³ x10 ³	W _{plz} ♦ mm ³ x10 ³	i _z mm x10	s _s mm	I _t mm ⁴ x10 ⁴	I _w mm ⁶ x10 ⁹	S235	S355	S460	S235	S355				S460
HE 100 AA	12,2	236,5	51,98	58,36	3,89	6,15	92,06	18,41	28,44	2,43	29,26	2,51	1,68	1	1	2	1	1	2	✓	✓	✓
HE 100 A	16,7	349,2	72,76	83,01	4,06	7,56	133,8	26,76	41,14	2,51	35,06	5,24	2,58	1	1	1	1	1	1	✓	✓	✓
HE 100 B	20,4	449,5	89,91	104,2	4,16	9,04	167,3	33,45	51,42	2,53	40,06	9,25	3,38	1	1	1	1	1	1	✓	✓	✓
HE 100 C	30,9	758,7	137,9	165,8	4,39	13,39	274,4	53,28	82,08	2,64	53,06	29,30	6,16	1	1	-	1	1	-	✓		
HE 100 M	41,8	1143	190,4	235,8	4,63	18,04	399,2	75,31	116,3	2,74	66,06	68,21	9,93	1	1	1	1	1	1	✓	✓	✓
HE 120 AA	14,6	413,4	75,85	84,12	4,72	6,90	158,8	26,47	40,62	2,93	29,26	2,78	4,24	1	3	3	1	3	3	✓	✓	✓
HE 120 A	19,9	606,2	106,3	119,5	4,89	8,46	230,9	38,48	58,85	3,02	35,06	5,99	6,47	1	1	1	1	1	1	✓	✓	✓
HE 120 B	26,7	864,4	144,1	165,2	5,04	10,96	317,5	52,92	80,97	3,06	42,56	13,84	9,41	1	1	1	1	1	1	✓	✓	✓
HE 120 C	39,2	1388	213,6	252,9	5,27	15,91	497,7	80,92	124,2	3,16	55,56	40,96	16,12	1	1	-	1	1	-	✓		
HE 120 M	52,1	2018	288,2	350,6	5,51	21,15	702,8	111,6	171,6	3,25	68,56	91,66	24,79	1	1	1	1	1	1	✓	✓	✓
HE 140 AA	18,1	719,5	112,4	123,8	5,59	7,92	274,8	39,26	59,93	3,45	30,36	3,54	10,21	2	3	3	2	3	3	✓	✓	✓
HE 140 A	24,7	1033	155,4	173,5	5,73	10,12	389,3	55,62	84,85	3,52	36,56	8,13	15,06	1	1	2	1	1	2	✓	✓	✓
HE 140 B	33,7	1509	215,6	245,4	5,93	13,08	549,7	78,52	119,8	3,58	45,06	20,06	22,48	1	1	1	1	1	1	✓	✓	✓
HE 140 C	48,2	2330	310,6	363,8	6,16	18,62	830,3	116,1	177,7	3,68	58,06	55,68	36,64	1	1	-	1	1	-	✓		
HE 140 M	63,2	3291	411,4	493,8	6,39	24,46	1144	156,8	240,5	3,77	71,06	120,0	54,33	1	1	1	1	1	1	✓	✓	✓
HE 160 AA	23,8	1283	173,4	190,4	6,50	10,38	478,7	59,84	91,36	3,97	36,07	6,33	23,75	1	3	3	1	3	3	✓	✓	✓
HE 160 A	30,4	1673	220,1	245,1	6,57	13,21	615,6	76,95	117,6	3,98	41,57	12,19	31,41	1	1	2	1	1	2	✓	✓	✓
HE 160 B	42,6	2492	311,5	354,0	6,78	17,59	889,2	111,2	170,0	4,05	51,57	31,24	47,94	1	1	1	1	1	1	✓	✓	✓
HE 160 C	59,2	3704	435,8	507,6	7,01	24,05	1302	159,8	244,9	4,16	64,57	79,21	75,04	1	1	-	1	1	-	✓		
HE 160 M	76,2	5098	566,5	674,6	7,25	30,81	1759	211,9	325,5	4,26	77,57	162,4	108,1	1	1	1	1	1	1	✓	✓	✓
HE 180 AA	28,7	1967	235,6	258,2	7,34	12,16	730,0	81,11	123,6	4,47	37,57	8,33	46,36	2	3	3	2	3	3	✓	✓	✓
HE 180 A	35,5	2510	293,6	324,9	7,45	14,47	924,6	102,7	156,5	4,52	42,57	14,80	60,21	1	2	3	1	2	3	✓	✓	✓
HE 180 B	51,2	3831	425,7	481,4	7,66	20,24	1363	151,4	231,0	4,57	54,07	42,16	93,75	1	1	1	1	1	1	✓	✓	✓
HE 180 C	69,8	5543	583,5	675,0	7,89	27,30	1944	212,5	324,9	4,68	67,07	102,1	141,9	1	1	-	1	1	-	✓		
HE 180 M	88,9	7483	748,3	883,4	8,13	34,65	2580	277,4	425,2	4,77	80,07	203,3	199,3	1	1	1	1	1	1	✓	✓	✓
HE 200 AA	34,6	2944	316,6	347,1	8,17	15,45	1068	106,8	163,2	4,92	42,59	12,69	84,49	2	3	3	2	3	3	✓	✓	✓
HE 200 A	42,3	3692	388,6	429,5	8,28	18,08	1336	133,6	203,8	4,98	47,59	20,98	108,0	1	2	3	1	2	3	✓	✓	✓
HE 200 B	61,3	5696	569,6	642,5	8,54	24,83	2003	200,3	305,8	5,07	60,09	59,28	171,1	1	1	1	1	1	1	✓	✓	✓
HE 200 C	81,9	8029	764,7	880,6	8,77	32,78	2794	275,3	421,0	5,17	73,09	135,1	251,7	1	1	-	1	1	-	✓		
HE 200 M	103	10640	967,4	1135	9,00	41,03	3651	354,5	543,2	5,27	86,09	259,4	346,3	1	1	1	1	1	1	✓	✓	✓

♦ W_{pl}: para el diseño plástico la sección debe pertenecer a la clase 1 o 2 según la capacidad de rotación que se precise. Véase pág. 203.
 ♦ W_{pl}: for plastic design, the shape must belong to class 1 or 2 according to the required rotation capacity. See page 203.
 ♦ W_{pl}: per il calcolo plastico, la sezione trasversale deve appartenere alla classe 1 o 2, conformemente alla capacità di rotazione richiesta. Vedere pagina 203.

Perfiles H de alas anchas (continúa)

Dim.: HE A, HE B y HE M 100 - 1000 conforme a la norma anterior EU 53-62; HE 1000 con $G_{HE} > G_{HEM}$ conforme a ASTM A 6/A 6M - 07
 HE C conforme a PN-H-93452: 2005; HE AA 100-1000 conforme a la norma de fábrica
 Tolerancias: EN 10034: 1993 HE 100 - 900; HE 1000 AA-M
 ASTM A 6/A 6M - 07 HE 1000 with $G_{HE} > G_{HEM}$
 Estado de la superficie: conforme a norma EN 10163-3: 2004, clase C, subclase 1

European wide flange beams (continued)

Dim.: HE A, HE B and HE M 100 - 1000 in accordance with former standard EU 53-62; HE 1000 with $G_{HE} > G_{HEM}$ in accordance with ASTM A 6/A 6M - 07
 HE C in accordance with PN-H-93452: 2005; HE AA 100-1000 in accordance with mill standard
 Tolerances: EN 10034: 1993 HE 100 - 900; HE 1000 AA-M
 ASTM A 6/A 6M - 07 HE 1000 with $G_{HE} > G_{HEM}$
 Surface condition: according to EN 10163-3: 2004, class C, subclass 1

Profili H ad ali larghe (continua)

Dim.: HE A, HE B and HE M 100 - 1000 secondo il vecchio standard EU 53-62; HE 1000 con $G_{HE} > G_{HEM}$ secondo ASTM A 6/A 6M - 07
 HE C secondo PN-H-93452: 2005; HE AA 100-1000 secondo lo standard dell'acciaieria
 Tolleranze: EN 10034: 1993 HE 100 - 900; HE 1000 AA-M
 ASTM A 6/A 6M - 07 HE 1000 con $G_{HE} > G_{HEM}$
 Condizioni di superficie: secondo EN 10163-3: 2004, classe C, sottoclasse 1

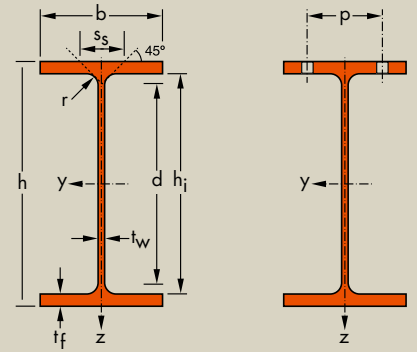

Denominación Designation Designazione	Dimensiones Dimensions Dimensioni						A mm ² x10 ²	Dimensiones de construcción Dimensions for detailing Dimensioni di dettaglio					Superficie Surface Superficie	
	G kg/m	h mm	b mm	t _w mm	t _r mm	r mm		h _i mm	d mm	Ø mm	p _{min} mm	p _{max} mm	A _L m ² /m	A _G m ² /t
HE 220 AA*	40,4	205	220	6	8,5	18	51,5	188	152	M 27	98	118	1,247	30,87
HE 220 A	50,5	210	220	7	11	18	64,3	188	152	M 27	98	118	1,255	24,85
HE 220 B	71,5	220	220	9,5	16	18	91,0	188	152	M 27	100	118	1,270	17,77
HE 220 C*	94,1	230	223	12,5	21	18	119,9	188	152	M 27	104	122	1,296	13,77
HE 220 M	117	240	226	15,5	26	18	149,4	188	152	M 27	108	124	1,322	11,27
HE 240 AA*	47,4	224	240	6,5	9	21	60,4	206	164	M 27	104	138	1,359	28,67
HE 240 A	60,3	230	240	7,5	12	21	76,8	206	164	M 27	104	138	1,369	22,70
HE 240 B	83,2	240	240	10	17	21	106,0	206	164	M 27	108	138	1,384	16,63
HE 240 C*	119	255	244	14	24,5	21	152,2	206	164	M 27	112	142	1,422	11,90
HE 240 M	157	270	248	18	32	21	199,6	206	164	M 27	116	146	1,460	9,318
HE 260 AA*	54,1	244	260	6,5	9,5	24	69,0	225	177	M 27	110	158	1,474	27,22
HE 260 A	68,2	250	260	7,5	12,5	24	86,8	225	177	M 27	110	158	1,484	21,77
HE 260 B	93,0	260	260	10	17,5	24	118,4	225	177	M 27	114	158	1,499	16,12
HE 260 C*	132	275	264	14	25	24	168,4	225	177	M 27	118	162	1,537	11,63
HE 260 M	172	290	268	18	32,5	24	219,6	225	177	M 27	122	166	1,575	9,133
HE 280 AA*	61,2	264	280	7	10	24	78,0	244	196	M 27	110	178	1,593	26,01
HE 280 A	76,4	270	280	8	13	24	97,3	244	196	M 27	112	178	1,603	20,99
HE 280 B	103	280	280	10,5	18	24	131,4	244	196	M 27	114	178	1,618	15,69
HE 280 C*	145	295	284	14,5	25,5	24	185,2	244	196	M 27	118	182	1,656	11,39
HE 280 M	189	310	288	18,5	33	24	240,2	244	196	M 27	122	186	1,694	8,984
HE 300 AA*	69,8	283	300	7,5	10,5	27	88,9	262	208	M 27	116	198	1,705	24,42
HE 300 A	88,3	290	300	8,5	14	27	112,5	262	208	M 27	118	198	1,717	19,43
HE 300 B	117	300	300	11	19	27	149,1	262	208	M 27	120	198	1,732	14,80
HE 300 C*	177	320	305	16	29	27	225,1	262	208	M 27	126	204	1,782	10,08
HE 300 M	238	340	310	21	39	27	303,1	262	208	M 27	132	208	1,832	7,699
HE 320 AA*	74,2	301	300	8	11	27	94,6	279	225	M 27	118	198	1,740	23,43
HE 320 A	97,6	310	300	9	15,5	27	124,4	279	225	M 27	118	198	1,756	17,98
HE 320 B	127	320	300	11,5	20,5	27	161,3	279	225	M 27	122	198	1,771	13,98
HE 320 C*	186	340	305	16	30,5	27	236,9	279	225	M 27	126	204	1,822	9,796
HE 320 M	245	359	309	21	40	27	312,0	279	225	M 27	132	204	1,866	7,616

· Pedido mínimo: para calidad S235 JR véase condiciones de suministro en pág. 216; para cualquier otra calidad 40 t o según acuerdo.
 * Tonelaje mínimo y condiciones de suministro previo acuerdo.

· Minimum order: for the S235 JR grade cf. delivery conditions page 216; for any other grade 40t or upon agreement.
 * Minimum tonnage and delivery conditions upon agreement.

· Ordine minimo: Per la qualità S235 JR vedere le condizioni di fornitura a pagina 216; per qualunque altra qualità: 40t o da concordare.
 * Tonnellaggio minimo e condizioni di fornitura da concordare.

Páginas de notaciones 199-203 / Notations pages 199-203 / Pagine di annotazioni 199-203

Denominación Designation Designazione	Propiedades del perfil / Section properties / Proprietà geometriche del profilo												Classification EN 1993-1-1: 2005						EN 10025-2: 2004	EN 10025-4: 2004	EN 10225:2001	
	eje fuerte y-y strong axis y-y asse forte y-y						eje débil z-z weak axis z-z asse debole z-z						Pure bending y-y			Pure compression						
	G	I_y	W_{ely}	$W_{ply}♦$	i_y	A_vz	I_z	W_{elz}	$W_{plz}♦$	i_z	s_s	I_t	I_w	S235	S355	S460	S235	S355				S460
kg/m	mm ⁴ x10 ⁴	mm ³ x10 ³	mm ³ x10 ³	mm x10	mm ² x10 ²	mm ⁴ x10 ⁴	mm ³ x10 ³	mm ³ x10 ³	mm x10	mm	mm ⁴ x10 ⁴	mm ⁶ x10 ⁹										
HE 220 AA	40,4	4170	406,9	445,5	9,00	17,63	1510	137,3	209,3	5,42	44,09	15,93	145,6	3	3	4	3	3	4	✓	✓	✓
HE 220 A	50,5	5410	515,2	568,5	9,17	20,67	1955	177,7	270,6	5,51	50,09	28,46	193,3	1	2	3	1	2	3	✓	✓	✓
HE 220 B	71,5	8091	735,5	827,0	9,43	27,92	2843	258,5	393,9	5,59	62,59	76,57	295,4	1	1	1	1	1	1	✓	✓	✓
HE 220 C	94,1	11180	972,2	1114	9,65	36,47	3888	348,7	532,4	5,69	75,59	168,2	423,9	1	1	-	1	1	-	✓		
HE 220 M	117	14600	1217	1419	9,89	45,31	5012	443,5	678,6	5,79	88,59	315,3	572,7	1	1	-	1	1	-	✓	✓	✓
HE 240 AA	47,4	5835	521,0	570,6	9,83	21,54	2077	173,1	264,4	5,87	49,10	22,98	239,6	3	3	4	3	3	4	✓	✓	✓
HE 240 A	60,3	7763	675,1	744,6	10,05	25,18	2769	230,7	351,7	6,00	56,10	41,55	328,5	1	2	3	1	2	3	✓	✓	✓
HE 240 B	83,2	11260	938,3	1053	10,31	33,23	3923	326,9	498,4	6,08	68,60	102,7	486,9	1	1	1	1	1	1	✓	✓	✓
HE 240 C	119	17330	1359	1564	10,67	46,35	5942	487,1	743,8	6,25	87,60	288,7	787,9	1	1	-	1	1	-	✓		
HE 240 M	157	24290	1799	2117	11,03	60,07	8153	657,5	1006	6,39	106,6	627,9	1152	1	1	-	1	1	-	✓	✓	✓
HE 260 AA	54,1	7981	654,1	714,5	10,76	24,75	2788	214,5	327,7	6,36	53,62	30,31	382,6	3	3	4	3	3	4	✓	✓	✓
HE 260 A	68,2	10450	836,4	919,8	10,97	28,76	3668	282,1	430,2	6,50	60,62	52,37	516,4	1	3	3	1	3	3	✓	HI	HI
HE 260 B	93,0	14920	1148	1283	11,22	37,59	5135	395,0	602,2	6,58	73,12	123,8	753,7	1	1	1	1	1	1	✓	HI	HI
HE 260 C	132	22590	1643	1880	11,58	51,94	7680	581,8	888,3	6,75	92,12	336,4	1198	1	1	-	1	1	-	✓		
HE 260 M	172	31310	2159	2524	11,94	66,89	10450	779,7	1192	6,90	111,1	719,0	1728	1	1	1	1	1	1	✓	HI	HI
HE 280 AA	61,2	10560	799,8	873,1	11,63	27,52	3664	261,7	399,4	6,85	55,12	36,22	590,1	3	3	4	3	3	4	✓	✓	✓
HE 280 A	76,4	13670	1013	1112	11,86	31,74	4763	340,2	518,1	7,00	62,12	62,10	785,4	1	3	3	1	3	3	✓	HI	HI
HE 280 B	103	19270	1376	1534	12,11	41,09	6595	471,0	717,6	7,09	74,62	143,7	1130	1	1	1	1	1	1	✓	HI	HI
HE 280 C	145	28810	1953	2225	12,47	56,26	9750	686,6	1047	7,26	93,62	382,5	1768	1	1	-	1	1	-	✓		
HE 280 M	189	39550	2551	2966	12,83	72,03	13160	914,1	1397	7,40	112,6	807,3	2520	1	1	1	1	1	1	✓	HI	HI
HE 300 AA	69,8	13800	975,6	1065	12,46	32,37	4734	315,6	482,3	7,30	60,13	49,35	877,2	3	3	4	3	3	4	✓	✓	✓
HE 300 A	88,3	18260	1260	1383	12,74	37,28	6310	420,6	641,2	7,49	68,13	85,17	1200	1	3	3	1	3	3	✓	HI	HI
HE 300 B	117	25170	1678	1869	12,99	47,43	8563	570,9	870,1	7,58	80,63	185,0	1688	1	1	1	1	1	1	✓	HI	HI
HE 300 C	177	40950	2559	2927	13,49	68,48	13736	900,7	1374	7,81	105,6	598,3	2903	1	1	-	1	1	-	✓		
HE 300 M	238	59200	3482	4078	13,98	90,53	19400	1252	1913	8,00	130,6	1408	4386	1	1	1	1	1	1	✓	HI	HI
HE 320 AA	74,2	16450	1093	1196	13,19	35,40	4959	330,6	505,7	7,24	61,63	55,87	1041	3	3	4	3	3	4	✓	✓	✓
HE 320 A	97,6	22930	1479	1628	13,58	41,13	6985	465,7	709,7	7,49	71,63	108,0	1512	1	2	3	1	2	3	✓	HI	HI
HE 320 B	127	30820	1926	2149	13,82	51,77	9239	615,9	939,1	7,57	84,13	225,1	2069	1	1	1	1	1	1	✓	HI	HI
HE 320 C	186	48710	2865	3274	14,34	72,25	14446	947	1445	7,81	108,6	679,1	3454	1	1	-	1	1	-	✓		
HE 320 M	245	68130	3796	4435	14,78	94,85	19710	1276	1951	7,95	132,6	1501	5004	1	1	1	1	1	1	✓	HI	HI

HI = HISTAR®

♦ W_{pl} : para el diseño plástico la sección debe pertenecer a la clase 1 o 2 según la capacidad de rotación que se precise. Véase pág. 203.
 ♦ W_{pl} : for plastic design, the shape must belong to class 1 or 2 according to the required rotation capacity. See page 203.
 ♦ W_{pl} : per di calcolo plastico, la sezione trasversale deve appartenere alla classe 1 o 2, conformemente alla capacità di rotazione richiesta. Vedere pagina 203.

Perfiles H de alas anchas (continúa)

Dim.: HE A, HE B y HE M 100 - 1000 conforme a la norma anterior EU 53-62; HE 1000 con $G_{HE} > G_{HEM}$ conforme a ASTM A 6/A 6M - 07
 HE C conforme a PN-H-93452: 2005; HE AA 100-1000 conforme a la norma de fábrica
 Tolerancias: EN 10034: 1993 HE 100 - 900; HE 1000 AA-M
 ASTM A 6/A 6M - 07 HE 1000 with $G_{HE} > G_{HEM}$

Estado de la superficie: conforme a norma EN 10163-3: 2004, clase C, subclase 1

European wide flange beams (continued)

Dim.: HE A, HE B and HE M 100 - 1000 in accordance with former standard EU 53-62; HE 1000 with $G_{HE} > G_{HEM}$ in accordance with ASTM A 6/A 6M - 07
 HE C in accordance with PN-H-93452: 2005; HE AA 100-1000 in accordance with mill standard
 Tolerances: EN 10034: 1993 HE 100 - 900; HE 1000 AA-M
 ASTM A 6/A 6M - 07 HE 1000 with $G_{HE} > G_{HEM}$

Surface condition: according to EN 10163-3: 2004, class C, subclass 1

Profili H ad ali larghe (continua)

Dim.: HE A, HE B and HE M 100 - 1000 secondo il vecchio standard EU 53-62; HE 1000 con $G_{HE} > G_{HEM}$ secondo ASTM A 6/A 6M - 07
 HE C secondo PN-H-93452: 2005; HE AA 100-1000 secondo lo standard dell'acciaieria
 Tolleranze: EN 10034: 1993 HE 100 - 900; HE 1000 AA-M
 ASTM A 6/A 6M - 07 HE 1000 con $G_{HE} > G_{HEM}$

Condizioni di superficie: secondo EN 10163-3: 2004, classe C, sottoclasse 1

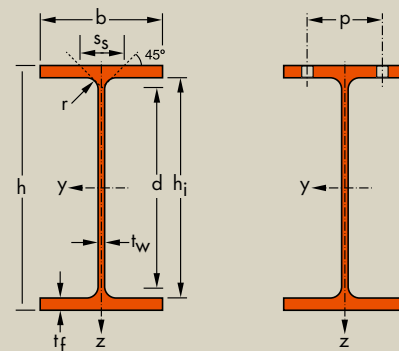

Denominación Designation Designazione	Dimensiones Dimensions Dimensioni						A mm ² x10 ²	Dimensiones de construcción Dimensions for detailing Dimensioni di dettaglio					Superficie Surface Superficie	
	G kg/m	h mm	b mm	t _w mm	t _r mm	r mm		h _i mm	d mm	Ø mm	p _{min} mm	p _{max} mm	A _L m ² /m	A _G m ² /t
HE 340 AA*	78,9	320	300	8,5	11,5	27	100,5	297	243	M 27	118	198	1,777	22,52
HE 340 A	105	330	300	9,5	16,5	27	133,5	297	243	M 27	118	198	1,795	17,13
HE 340 B	134	340	300	12	21,5	27	170,9	297	243	M 27	122	198	1,810	13,49
HE 340 M	248	377	309	21	40	27	315,8	297	243	M 27	132	204	1,902	7,670
HE 360 AA*	83,7	339	300	9	12	27	106,6	315	261	M 27	118	198	1,814	21,67
HE 360 A	112	350	300	10	17,5	27	142,8	315	261	M 27	120	198	1,834	16,36
HE 360 B	142	360	300	12,5	22,5	27	180,6	315	261	M 27	122	198	1,849	13,04
HE 360 M	250	395	308	21	40	27	318,8	315	261	M 27	132	204	1,934	7,730
HE 400 AA*	92,4	378	300	9,5	13	27	117,7	352	298	M 27	118	198	1,891	20,46
HE 400 A	125	390	300	11	19	27	159,0	352	298	M 27	120	198	1,912	15,32
HE 400 B	155	400	300	13,5	24	27	197,8	352	298	M 27	124	198	1,927	12,41
HE 400 M	256	432	307	21	40	27	325,8	352	298	M 27	132	202	2,004	7,835
HE 450 AA*	99,7	425	300	10	13,5	27	127,1	398	344	M 27	120	198	1,984	19,89
HE 450 A	140	440	300	11,5	21	27	178,0	398	344	M 27	122	198	2,011	14,39
HE 450 B	171	450	300	14	26	27	218,0	398	344	M 27	124	198	2,026	11,84
HE 450 M	263	478	307	21	40	27	335,4	398	344	M 27	132	202	2,096	7,959
HE 500 AA*	107	472	300	10,5	14	27	136,9	444	390	M 27	120	198	2,077	19,33
HE 500 A	155	490	300	12	23	27	197,5	444	390	M 27	122	198	2,110	13,60
HE 500 B	187	500	300	14,5	28	27	238,6	444	390	M 27	124	198	2,125	11,34
HE 500 M	270	524	306	21	40	27	344,3	444	390	M 27	132	202	2,184	8,079
HE 550 AA*	120	522	300	11,5	15	27	152,8	492	438	M 27	122	198	2,175	18,13
HE 550 A	166	540	300	12,5	24	27	211,8	492	438	M 27	122	198	2,209	13,29
HE 550 B	199	550	300	15	29	27	254,1	492	438	M 27	124	198	2,224	11,15
HE 550 M	278	572	306	21	40	27	354,4	492	438	M 27	132	202	2,280	8,195
HE 600 AA*	129	571	300	12	15,5	27	164,1	540	486	M 27	122	198	2,272	17,64
HE 600 A	178	590	300	13	25	27	226,5	540	486	M 27	122	198	2,308	12,98
HE 600 B	212	600	300	15,5	30	27	270,0	540	486	M 27	126	198	2,323	10,96
HE 600 M	285	620	305	21	40	27	363,7	540	486	M 27	132	200	2,372	8,308
HE 600 x 337*	337	632	310	25,5	46	27	429,2	540	486	M 27	138	202	2,407	7,144
HE 600 x 399*	399	648	315	30	54	27	508,5	540	486	M 27	142	208	2,450	6,137

- Pedido mínimo: para calidad S235 JR véase condiciones de suministro en pág. 216; para cualquier otra calidad 40 t o según acuerdo.
- Minimum order: for the S235 JR grade cf. delivery conditions page 216; for any other grade 40t or upon agreement.
- Ordine minimo: Per la qualità S235 JR vedere le condizioni di fornitura a pagina 216; per qualunque altra qualità: 40t o da concordare.

Páginas de notaciones 199-203 / Notations pages 199-203 / Pagine di annotazioni 199-203

Denominación Designation Designazione	Propiedades del perfil / Section properties / Proprietà geometriche del profilo													Classification EN 1993-1-1: 2005						EN 10025-2: 2004	EN 10025-4: 2004	EN 10225:2001
	eje fuerte y-y strong axis y-y asse forte y-y						eje débil z-z weak axis z-z asse debole z-z				Pure bending y-y			Pure compression								
	G kg/m	I_y mm ⁴ x10 ⁴	W_{ely} mm ³ x10 ³	$W_{ply}♦$ mm ³ x10 ³	i_y mm x10	A_{vz} mm ² x10 ²	I_z mm ⁴ x10 ⁴	W_{elz} mm ³ x10 ³	$W_{plz}♦$ mm ³ x10 ³	i_z mm x10	s_s mm	I_t mm ⁴ x10 ⁴	I_w mm ⁶ x10 ⁹	S235	S355	S460	S235	S355	S460			
HE 340 AA	78,9	19550	1222	1341	13,95	38,69	5185	345,6	529,3	7,18	63,13	63,07	1231	3	3	4	3	3	4	✓	✓	✓
HE 340 A	105	27690	1678	1850	14,40	44,95	7436	495,7	755,9	7,46	74,13	127,2	1824	1	1	3	1	1	3	✓	HI	HI
HE 340 B	134	36660	2156	2408	14,65	56,09	9690	646,0	985,7	7,53	86,63	257,2	2454	1	1	1	1	1	1	✓	HI	HI
HE 340 M	248	76370	4052	4718	15,55	98,63	19710	1276	1953	7,90	132,6	1506	5584	1	1	1	1	1	1	✓	HI	HI
HE 360 AA	83,7	23040	1359	1495	14,70	42,17	5410	360,7	553,0	7,12	64,63	70,99	1444	2	3	3	2	3	3	✓	✓	✓
HE 360 A	112	33090	1891	2088	15,22	48,96	7887	525,8	802,3	7,43	76,63	148,8	2177	1	1	2	1	1	2	✓	HI	HI
HE 360 B	142	43190	2400	2683	15,46	60,60	10140	676,1	1032	7,49	89,13	292,5	2883	1	1	1	1	1	1	✓	HI	HI
HE 360 M	250	84870	4297	4989	16,32	102,4	19520	1268	1942	7,83	132,6	1507	6137	1	1	1	1	1	1	✓	HI	HI
HE 400 AA	92,4	31250	1654	1824	16,30	47,95	5861	390,8	599,7	7,06	67,13	84,69	1948	2	3	3	2	3	4	✓	✓	✓
HE 400 A	125	45070	2311	2562	16,84	57,33	8564	570,9	872,9	7,34	80,63	189,0	2942	1	1	1	1	2	2	✓	HI	HI
HE 400 B	155	57680	2884	3232	17,08	69,98	10820	721,3	1104	7,40	93,13	355,7	3817	1	1	1	1	1	1	✓	HI	HI
HE 400 M	256	104100	4820	5571	17,88	110,2	19340	1260	1934	7,70	132,6	1515	7410	1	1	1	1	1	1	✓	HI	HI
HE 450 AA	99,7	41890,0	1971	2183	18,16	54,70	6088	405,8	624,4	6,92	68,63	95,61	2572	1	3	3	2	4	4	✓	✓	✓
HE 450 A	140	63720	2896	3216	18,92	65,78	9465	631,0	965,5	7,29	85,13	243,8	4148	1	1	1	1	2	3	✓	HI	HI
HE 450 B	171	79890	3551	3982	19,14	79,66	11720	781,4	1198	7,33	97,63	440,5	5258	1	1	1	1	1	2	✓	HI	HI
HE 450 M	263	131500	5501	6331	19,80	119,8	19340	1260	1939	7,59	132,6	1529	9251	1	1	1	1	1	1	✓	HI	HI
HE 500 AA	107	54640	2315	2576	19,98	61,91	6314	420,9	649,3	6,79	70,13	107,7	3304	1	3	3	2	4	4	✓	✓	✓
HE 500 A	155	86970	3550	3949	20,98	74,72	10370	691,1	1059	7,24	89,63	309,3	5643	1	1	1	1	3	4	✓	HI	HI
HE 500 B	187	107200	4287	4815	21,19	89,82	12620	841,6	1292	7,27	102,1	538,4	7018	1	1	1	1	2	2	✓	HI	HI
HE 500 M	270	161900	6180	7094	21,69	129,5	19150	1252	1932	7,46	132,6	1539	11190	1	1	1	1	1	1	✓	HI	HI
HE 550 AA	120	72870	2792	3128	21,84	72,66	6767	451,1	698,6	6,65	73,13	133,7	4338	1	2	3	3	4	4	✓	✓	✓
HE 550 A	166	111900	4146	4622	22,99	83,72	10820	721,3	1107	7,15	92,13	351,5	7189	1	1	1	2	4	4	✓	HI	HI
HE 550 B	199	136700	4971	5591	23,20	100,1	13080	871,8	1341	7,17	104,6	600,3	8856	1	1	1	1	2	3	✓	HI	HI
HE 550 M	278	198000	6923	7933	23,64	139,6	19160	1252	1937	7,35	132,6	1554	13520	1	1	1	1	1	1	✓	HI	HI
HE 600 AA	129	91900	3218	3623	23,66	81,29	6993	466,2	724,5	6,53	74,63	149,8	5381	1	2	3	3	4	4	✓	✓	✓
HE 600 A	178	141200	4787	5350	24,97	93,21	11270	751,4	1156	7,05	94,63	397,8	8978	1	1	1	2	4	4	✓	HI	HI
HE 600 B	212	171000	5701	6425	25,17	110,8	13530	902,0	1391	7,08	107,1	667,2	10970	1	1	1	1	3	4	✓	HI	HI
HE 600 M	285	237400	7660	8772	25,55	149,7	18980	1244	1930	7,22	132,6	1564	15910	1	1	1	1	1	1	✓	HI	HI
HE 600 x 337	337	283200	8961	10380	25,69	180,5	22940	1480	2310	7,31	149,1	2451	19610	1	1	1	1	1	1	✓	HI	
HE 600 x 399	399	344600	10640	12460	26,03	213,6	28280	1796	2814	7,46	169,6	3966	24810	1	1	1	1	1	1	✓	HI	

HI = HISTAR®

♦ W_{pl} : para el diseño plástico la sección debe pertenecer a la clase 1 o 2 según la capacidad de rotación que se precise. Véase pág. 203.
 ♦ W_{pl} : for plastic design, the shape must belong to class 1 or 2 according to the required rotation capacity. See page 203.
 ♦ W_{pl} : per di calcolo plastico, la sezione trasversale deve appartenere alla classe 1 o 2, conformemente alla capacità di rotazione richiesta. Vedere pagina 203.

Perfiles H de alas anchas (continúa)

Dim.: HE A, HE B y HE M 100 - 1000 conforme a la norma anterior EU 53-62; HE 1000 con $G_{HE} > G_{HEM}$ conforme a ASTM A 6/A 6M - 07
HE C conforme a PN-H-93452: 2005; HE AA 100-1000 conforme a la norma de fábrica
Tolerancias: EN 10034: 1993 HE 100 - 900; HE 1000 AA-M
ASTM A 6/A 6M - 07 HE 1000 with $G_{HE} > G_{HEM}$

Estado de la superficie: conforme a norma EN 10163-3: 2004, clase C, subclase 1

European wide flange beams (continued)

Dim.: HE A, HE B and HE M 100 - 1000 in accordance with former standard EU 53-62; HE 1000 with $G_{HE} > G_{HEM}$ in accordance with ASTM A 6/A 6M - 07
HE C in accordance with PN-H-93452: 2005; HE AA 100-1000 according to mill standard
Tolerances: EN 10034: 1993 HE 100 - 900; HE 1000 AA-M
ASTM A 6/A 6M - 07 HE 1000 with $G_{HE} > G_{HEM}$

Surface condition: according to EN 10163-3: 2004, class C, subclass 1

Profili H ad ali larghe (continua)

Dim.: HE A, HE B and HE M 100 - 1000 secondo il vecchio standard EU 53-62; HE 1000 con $G_{HE} > G_{HEM}$ secondo ASTM A 6/A 6M - 07
HE C secondo PN-H-93452: 2005; HE AA 100-1000 secondo lo standard dell'acciaieria
Tolleranze: EN 10034: 1993 HE 100 - 900; HE 1000 AA-M
ASTM A 6/A 6M - 07 HE 1000 con $G_{HE} > G_{HEM}$

Condizioni di superficie: secondo EN 10163-3: 2004, classe C, sottoclasse 1

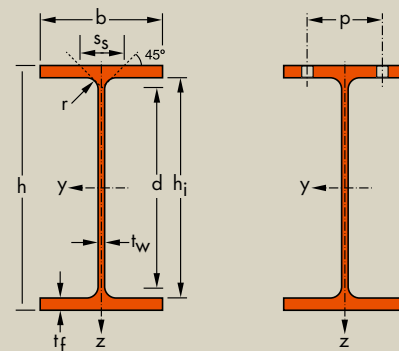

Denominación Designation Designazione	Dimensiones Dimensions Dimensioni						A mm ² x10 ²	Dimensiones de construcción Dimensions for detailing Dimensioni di dettaglio					Superficie Surface Superficie	
	G kg/m	h mm	b mm	t _w mm	t _r mm	r mm		h _i mm	d mm	Ø mm	p _{min} mm	p _{max} mm	A _L m ² /m	A _G m ² /t
HE 650 AA*	138	620	300	12,5	16	27	175,8	588	534	M 27	122	198	2,369	17,17
HE 650 A	190	640	300	13,5	26	27	241,6	588	534	M 27	124	198	2,407	12,69
HE 650 B	225	650	300	16	31	27	286,3	588	534	M 27	126	198	2,422	10,77
HE 650 M	293	668	305	21	40	27	373,7	588	534	M 27	132	200	2,468	8,411
HE 650 x 343*	343	680	309	25	46	27	437,5	588	534	M 27	138	202	2,500	7,278
HE 650 x 407*	407	696	314	29,5	54	27	518,8	588	534	M 27	142	206	2,543	6,243
HE 700 AA*	150	670	300	13	17	27	190,9	636	582	M 27	122	198	2,468	16,46
HE 700 A	204	690	300	14,5	27	27	260,5	636	582	M 27	124	198	2,505	12,25
HE 700 B	241	700	300	17	32	27	306,4	636	582	M 27	126	198	2,520	10,48
HE 700 M	301	716	304	21	40	27	383,0	636	582	M 27	132	200	2,560	8,513
HE 700 x 352*	352	728	308	25	46	27	448,6	636	582	M 27	138	200	2,592	7,359
HE 700 x 418*	418	744	313	29,5	54	27	531,9	636	582	M 27	142	206	2,635	6,310
HE 800 AA*	172	770	300	14	18	30	218,5	734	674	M 27	130	198	2,660	15,51
HE 800 A	224	790	300	15	28	30	285,8	734	674	M 27	130	198	2,698	12,03
HE 800 B	262	800	300	17,5	33	30	334,2	734	674	M 27	134	198	2,713	10,34
HE 800 M	317	814	303	21	40	30	404,3	734	674	M 27	138	198	2,746	8,655
HE 800 x 373*	373	826	308	25	46	30	474,6	734	674	M 27	144	200	2,782	7,469
HE 800 x 444*	444	842	313	30	54	30	566,0	734	674	M 27	148	206	2,824	6,357
HE 900 AA*	198	870	300	15	20	30	252,2	830	770	M 27	130	198	2,858	14,44
HE 900 A	252	890	300	16	30	30	320,5	830	770	M 27	132	198	2,896	11,51
HE 900 B	291	900	300	18,5	35	30	371,3	830	770	M 27	134	198	2,911	9,99
HE 900 M	333	910	302	21	40	30	423,6	830	770	M 27	138	198	2,934	8,824
HE 900 x 391*	391	922	307	25	46	30	497,7	830	770	M 27	144	200	2,970	7,604
HE 900 x 466*	466	938	312	30	54	30	593,7	830	770	M 27	148	204	3,012	6,464
HE 1000 AA*	222	970	300	16	21	30	282,2	928	868	M 27	132	198	3,056	13,80
HE 1000 x 249*	249	980	300	16,5	26	30	316,8	928	868	M 27	134	194	3,080	12,37
HE 1000 A	272	990	300	16,5	31	30	346,8	928	868	M 27	132	198	3,095	11,37
HE 1000 B	314	1000	300	19	36	30	400,0	928	868	M 27	134	198	3,110	9,905
HE 1000 M	349	1008	302	21	40	30	444,2	928	868	M 27	138	198	3,130	8,978
HE 1000 x 393*	393	1016	303	24,4	43,9	30	500,2	928	868	M 27	142	198	3,140	8,010
HE 1000 x 415*	415	1020	304	26	46	30	528,7	928	868	M 27	144	198	3,150	7,600
HE 1000 x 438*	438	1026	305	26,9	49	30	556,0	928	868	M 27	146	198	3,170	7,250
HE 1000 x 494*	494	1036	309	31	54	30	629,1	928	868	M 27	148	204	3,190	6,470
HE 1000 x 584*	584	1056	314	36	64	30	743,7	928	868	M 27	154	208	3,240	5,560

- Pedido mínimo: para calidad S235 JR véase condiciones de suministro en pág. 216; para cualquier otra calidad 40 t o según acuerdo.
- Minimum order: for the S235 JR grade cf. delivery conditions page 216; for any other grade 40t or upon agreement.
- Ordine minimo: Per la qualità S235 JR vedere le condizioni di fornitura a pagina 216; per qualunque altra qualità: 40t o da concordare.

Páginas de notaciones 199-203 / Notations pages 199-203 / Pagine di annotazioni 199-203

Denominación Designation Designazione	Propiedades del perfil / Section properties / Proprietà geometriche del profilo													Classification EN 1993-1-1: 2005						EN 10025-2: 2004	EN 10025-4: 2004	EN 10225:2001
	eje fuerte y-y strong axis y-y asse forte y-y						eje débil z-z weak axis z-z asse debole z-z				Pure bending y-y			Pure compression								
	G kg/m	I _y mm ⁴ x10 ⁴	W _{ely} mm ³ x10 ³	W _{ply} ♦ mm ³ x10 ³	i _y mm x10	A _{vz} mm ² x10 ²	I _z mm ⁴ x10 ⁴	W _{elz} mm ³ x10 ³	W _{plz} ♦ mm ³ x10 ³	i _z mm x10	s _s mm	I _t mm ⁴ x10 ⁴	I _w mm ⁶ x10 ⁹	S235	S355	S460	S235	S355	S460			
HE 650 AA	138	113900	3676	4160	25,46	90,40	7221	481,4	750,7	6,41	76,13	167,5	6567	1	1	3	4	4	4	✓	✓	✓
HE 650 A	190	175200	5474	6136	26,93	103,2	11720	781,6	1205	6,97	97,13	448,3	11030	1	1	1	3	4	4	✓	HI	HI
HE 650 B	225	210600	6480	7320	27,12	122,0	13980	932,3	1441	6,99	109,6	739,2	13360	1	1	1	2	3	4	✓	HI	HI
HE 650 M	293	281700	8433	9657	27,45	159,7	18980	1245	1936	7,13	132,6	1579	18650	1	1	1	1	1	2	✓	HI	HI
HE 650 x 343	343	333700	9815	11350	27,62	189,6	22720	1470	2300	7,21	148,6	2442	22730	1	1	1	1	1	1	✓	HI	
HE 650 x 407	407	405400	11650	13620	27,95	224,8	28020	1785	2803	7,35	169,1	3958	28710	1	1	1	1	1	1	✓	HI	
HE 700 AA	150	142700	4260	4840	27,34	100,3	7673	511,5	799,7	6,34	78,63	195,2	8155	1	1	2	4	4	4	✓	✓	✓
HE 700 A	204	215300	6241	7032	28,75	117,0	12180	811,9	1257	6,84	100,1	513,9	13350	1	1	1	3	4	4	✓	HI	HI
HE 700 B	241	256900	7340	8327	28,96	137,1	14440	962,7	1495	6,87	112,6	830,9	16060	1	1	1	2	4	4	✓	HI	HI
HE 700 M	301	329300	9198	10540	29,32	169,8	18800	1240	1929	7,01	132,6	1589	21400	1	1	1	1	2	3	✓	HI	HI
HE 700 x 352	352	389700	10710	12390	29,47	201,6	22510	1461	2293	7,08	148,6	2461	26050	1	1	1	1	1	1	✓	HI	
HE 700 x 418	418	472500	12700	14840	29,80	239,0	27760	1774	2797	7,22	169,1	3989	32850	1	1	1	1	1	1	✓	HI	
HE 800 AA	172	208900	5426	6225	30,92	123,8	8134	542,2	856,6	6,10	85,15	256,8	11450	1	1	1	4	4	4	✓	✓	✓
HE 800 A	224	303400	7682	8699	32,58	138,8	12640	842,6	1312	6,65	106,1	596,9	18290	1	1	1	4	4	4	✓	HI	HI
HE 800 B	262	359100	8977	10230	32,78	161,8	14900	993,6	1553	6,68	118,6	946,0	21840	1	1	1	3	4	4	✓	HI	HI
HE 800 M	317	442600	10870	12490	33,09	194,3	18630	1230	1930	6,79	136,1	1646	27780	1	1	1	1	3	4	✓	HI	HI
HE 800 x 373	373	523900	12690	14700	33,23	230,3	22530	1463	2311	6,89	152,1	2554	34070	1	1	1	1	2	2	✓	HI	
HE 800 x 444	444	634500	15070	17640	33,48	276,5	27800	1776	2827	7,01	173,1	4180	42840	1	1	1	1	1	1	✓	HI	
HE 900 AA	198	301100	6923	7999	34,55	147,2	9041	602,8	957,7	5,99	90,15	334,9	16260	1	1	1	4	4	4	✓	✓	✓
HE 900 A	252	422100	9485	10810	36,29	163,3	13550	903,2	1414	6,50	111,1	736,8	24960	1	1	1	4	4	4	✓	HI	HI
HE 900 B	291	494100	10980	12580	36,48	188,8	15820	1050	1658	6,53	123,6	1137	29460	1	1	1	3	4	4	✓	HI	HI
HE 900 M	333	570400	12540	14440	36,70	214,4	18450	1220	1929	6,60	136,1	1671	34750	1	1	1	2	4	4	✓	HI	HI
HE 900 x 391	391	674300	14630	16990	36,81	254,3	22320	1454	2312	6,70	152,1	2597	42560	1	1	1	1	2	4	✓	HI	
HE 900 x 466	466	814900	17380	20380	37,05	305,3	27560	1767	2832	6,81	173,1	4256	53400	1	1	1	1	1	2	✓	HI	
HE 1000 AA	222	406500	8380	9777	37,95	172,2	9501	633,4	1016	5,80	93,15	403,4	21280	1	1	-	4	4	-	✓		
HE 1000 x 249	249	481100	9818	11350	38,97	180,7	11750	784,0	1245	6,09	103,6	584,4	26620	1	1	2	4	4	4	✓	HI	HI
HE 1000 A	272	553800	11190	12820	39,96	184,6	14000	933,6	1470	6,35	113,6	822,4	32070	1	1	2	4	4	4	✓	HI	HI
HE 1000 B	314	644700	12890	14860	40,15	212,5	16280	1085	1716	6,38	126,1	1254	37640	1	1	1	4	4	4	✓	HI	HI
HE 1000 M	349	722300	14330	16570	40,32	235,0	18460	1222	1940	6,45	136,1	1701	43020	1	1	1	3	4	4	✓	HI	HI
HE 1000 x 393	393	807700	15900	18540	40,18	271,3	20500	1353	2168	6,40	147,3	2332	48080	1	1	1	2	4	4	✓	HI	
HE 1000 x 415	415	853100	16728	19571	40,17	288,6	21710	1428	2298	6,41	153,1	2713	51080	1	1	1	2	3	4	✓	HI	
HE 1000 x 438	438	909200	17720	20750	40,43	299,9	23360	1531	2463	6,48	160,0	3190	55290	1	1	1	1	3	4	✓	HI	
HE 1000 x 494	494	1028000	19845	23413	40,42	344,5	26820	1736	2818	6,53	174,1	4433	64010	1	1	1	1	2	3	✓	HI	
HE 1000 x 584	584	1246100	23600	28039	40,93	403,2	33430	2130	3475	6,70	199,1	7230	81240	1	1	1	1	1	2	✓	HI	

HI = HISTAR®

♦ W_{pl}: para el diseño plástico la sección debe pertenecer a la clase 1 o 2 según la capacidad de rotación que se precise. Véase pág. 203.
 ♦ W_{pl}: for plastic design, the shape must belong to class 1 or 2 according to the required rotation capacity. See page 203.
 ♦ W_{pl}: per il calcolo plastico, la sezione trasversale deve appartenere alla classe 1 o 2, conformemente alla capacità di rotazione richiesta. Vedere pagina 203.

Perfiles H de alas muy anchas

Dimensiones: ASTM A 6/A 6M - 07

Tolerancias: ASTM A 6/A 6M - 07

Estado de la superficie: conforme a norma EN 10163-3: 2004, clase C, subclase 1

European extra wide flange beams

Dimensions: ASTM A 6/A 6M - 07

Tolerances: ASTM A 6/A 6M - 07

Surface condition: according to EN 10163-3: 2004, class C, subclass 1

Profili H ad ali extra larghe

Dimensioni: ASTM A 6/A 6M - 07

Tolleranze: ASTM A 6/A 6M - 07

Condizioni di superficie: secondo EN 10163-3: 2004, classe C, sottoclasse 1

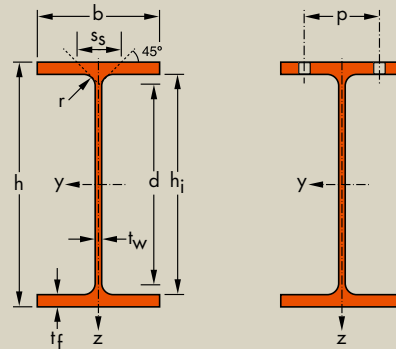

Denominación Designation Designazione	Dimensiones Dimensions Dimensioni						A mm ² x10 ²	Dimensiones de construcción Dimensions for detailing Dimensioni di dettaglio					Superficie Surface Superficie	
	G kg/m	h mm	b mm	t _w mm	t _r mm	r mm		h _i mm	d mm	Ø mm	p _{min} mm	p _{max} mm	A _L m ² /m	A _G m ² /t
HL 920 X 342*	342	912	418	19,3	32,0	24	436,1	848,0	800,0	M 27	126	312	3,416	9,978
HL 920 X 365*	365	916	419	20,3	34,3	24	464,4	847,4	799,4	M 27	128	314	3,426	9,398
HL 920 X 387*	387	921	420	21,3	36,6	24	493,0	847,8	799,8	M 27	128	314	3,438	8,885
HL 920 X 417*	417	928	422	22,5	39,9	24	532,5	848,2	800,2	M 27	130	316	3,458	8,271
HL 920 X 446*	446	933	423	24,0	42,7	24	569,6	847,6	799,6	M 27	130	318	3,469	7,758
HL 920 X 488*	488	942	422	25,9	47,0	24	621,3	848,0	800,0	M 27	132	316	3,479	7,134
HL 920 X 534*	534	950	425	28,4	51,1	24	680,1	847,8	799,8	M 27	136	320	3,502	6,560
HL 920 X 585*	585	960	427	31,0	55,9	24	745,3	848,2	800,2	M 27	138	322	3,525	6,025
HL 920 X 653*	653	972	431	34,5	62,0	24	831,9	848,0	800,0	M 27	144	320	3,558	5,448
HL 920 X 784*	784	996	437	40,9	73,9	24	997,7	848,2	800,2	M 27	152	326	3,617	4,618
HL 920 X 967*	967	1028	446	50,0	89,9	24	1231	848,2	800,2	M 27	160	334	3,699	3,828
HL 920 x 344*	344	927	418	19,3	32,0	19	437,2	863,0	825,0	M 27	126	312	3,455	10,07
HL 920 x 368*	368	931	419	20,3	34,3	19	465,6	862,4	824,4	M 27	128	314	3,465	9,480
HL 920 x 390*	390	936	420	21,3	36,6	19	494,3	862,8	824,8	M 27	128	314	3,477	8,960
HL 920 x 420*	420	943	422	22,5	39,9	19	534,1	863,2	825,2	M 27	130	316	3,496	8,340
HL 920 x 449*	449	948	423	24,0	42,7	19	571,4	862,6	824,6	M 27	130	318	3,507	7,820
HL 920 x 491*	491	957	422	25,9	47,0	19	623,3	863,0	825,0	M 27	132	316	3,518	7,189
HL 920 x 537*	537	965	425	28,4	51,1	19	682,5	862,8	824,8	M 27	136	320	3,541	6,609
HL 920 x 588*	588	975	427	31,0	55,9	19	748,1	863,2	825,2	M 27	138	322	3,563	6,068
HL 920 x 656*	656	987	431	34,5	62,0	19	835,3	863,0	825,0	M 27	144	320	3,596	5,485
HL 920 x 725*	725	999	434	38,1	68,1	19	922,9	862,8	824,8	M 27	148	323	3,625	5,004
HL 920 x 787*	787	1011	437	40,9	73,9	19	1002	863,2	825,2	M 27	152	326	3,656	4,647
HL 920 x 970*	970	1043	446	50,0	89,9	19	1237	863,2	825,2	M 27	160	334	3,737	3,850
HL 1000 AA*	296	982	400	16,5	27,1	30	377,6	928,0	868,0	M 27	134	294	3,479	11,74
HL 1000 A*	321	990	400	16,5	31,0	30	408,8	928,0	868,0	M 27	134	294	3,495	10,89
HL 1000 B*	371	1000	400	19,0	36,1	30	472,8	928,0	868,0	M 27	136	294	3,510	9,458
HL 1000 M*	412	1008	402	21,1	40,0	30	525,1	928,0	868,0	M 27	140	296	3,530	8,564
HL 1000 x 443*	443	1012	402	23,6	41,9	30	563,7	928,2	868,2	M 27	142	296	3,533	7,985
HL 1000 x 483*	483	1020	404	25,4	46,0	30	615,1	928,0	868,0	M 27	144	298	3,554	7,360
HL 1000 x 539*	539	1030	407	28,4	51,1	30	687,2	927,8	867,8	M 27	146	302	3,580	6,636

* Pedido mínimo: para calidad S235 JR véanse condiciones de suministro en pág. 216; para cualquier otra calidad 40 t o según acuerdo.

* Tonelaje mínimo y condiciones de suministro previo acuerdo.

* Perfil conforme a ASTM A 6/A 6M - 03c

* Minimum order: for the S235 JR grade cf. delivery conditions page 216; for any other grade 40t or upon agreement.

* Minimum tonnage and delivery conditions upon agreement.

* Section in accordance with ASTM A 6/A 6M - 03c

* Ordine minimo: Per la qualità S235 JR vedere le condizioni di fornitura a pagina 216; per qualunque altra qualità: 40t o da concordare.

* Tonnellaggio minimo e condizioni di fornitura da concordare.

* Sezione secondo ASTM A 6/A 6M - 03c

Páginas de notaciones 199-203 / Notations pages 199-203 / Pagine di annotazioni 199-203

Denominación Designation Designazione	Propiedades del perfil / Section properties / Proprietà geometriche del profilo													Classification EN 1993-1-1: 2005						EN 10025-2: 2004	EN 10025-4: 2004	EN 10225:2001
	eje fuerte y-y strong axis y-y asse forte y-y						eje débil z-z weak axis z-z asse debole z-z				Pure bending y-y			Pure compression								
	G	I_y	W_{ely}	$W_{ply} \blacklozenge$	i_y	A_{vz}	I_z	W_{elz}	$W_{plz} \blacklozenge$	i_z	s_s	I_t	I_w	S235	S355	S460	S235	S355	S460			
kg/m	mm ⁴ x10 ⁴	mm ³ x10 ³	mm ³ x10 ³	mm x10	mm ² x10 ²	mm ⁴ x10 ⁴	mm ³ x10 ³	mm ³ x10 ³	mm x10	mm	mm ⁴ x10 ⁴	mm ⁶ x10 ⁹										
HL 920 X 342	230	624900	13700	15450	37,85	190,1	39010	1867	2882	9,46	111,4	1193	75410	1	1	1	3	4	4	✓	HI	HI
HL 920 X 365	245	670500	14640	16520	38,00	200,4	42120	2011	3106	9,52	117,0	1446	81730	1	1	1	3	4	4	✓	HI	HI
HL 920 X 387	260	718300	15600	17630	38,17	210,9	45280	2156	3332	9,58	122,6	1734	88370	1	1	1	2	4	4	✓	HI	HI
HL 920 X 417	280	787600	16970	19210	38,46	223,9	50070	2373	3668	9,70	130,4	2200	98540	1	1	1	2	4	4	✓	HI	HI
HL 920 X 446	300	846800	18150	20600	38,56	239,1	53980	2552	3951	9,73	137,5	2685	106700	1	1	1	2	3	4	✓	HI	
HL 920 X 488	328	935400	19860	22610	38,80	259,3	59010	2797	4336	9,75	148,0	3514	117900	1	1	1	1	2	4	✓	HI	
HL 920 X 534	359	1031000	21710	24830	38,94	284,8	65560	3085	4796	9,82	158,7	4542	132100	1	1	1	1	2	3	✓	HI	
HL 920 X 585	393	1143000	23810	27360	39,16	312,0	72770	3408	5310	9,88	170,9	5932	148200	1	1	1	1	1	2	✓	HI	
HL 920 X 653	439	1292000	26590	30730	39,41	348,7	83050	3854	6022	9,99	186,6	8124	171300	1	1	1	1	1	1	✓	HI	
HL 920 X 784	527	1593000	31980	37340	39,95	417,6	103300	4728	7424	10,18	216,8	13730	218500	1	1	-	1	1	-	○		
HL 920 X 967	650	2033000	39540	46810	40,64	517,1	133900	6003	9486	10,43	257,9	24930	292400	1	1	-	1	1	-	○		
HL 920 x 344	344	645000	13920	15700	38,41	188,0	39010	1867	2880	9,45	105,6	1159	78120	1	1	1	4	4	4	✓	HI	HI
HL 920 x 368	368	692200	14870	16790	38,56	198,2	42120	2010	3104	9,51	111,2	1408	84670	1	1	1	3	4	4	✓	HI	HI
HL 920 x 390	390	741700	15850	17920	38,74	208,6	45270	2156	3331	9,57	116,8	1691	91550	1	1	1	3	4	4	✓	HI	HI
HL 920 x 420	420	813300	17250	19530	39,02	221,5	50070	2373	3667	9,68	124,6	2151	102100	1	1	1	2	4	4	✓	HI	HI
HL 920 x 449	449	874700	18450	20950	39,13	236,6	53970	2552	3949	9,72	131,7	2627	110600	1	1	1	2	4	4	✓	HI	
HL 920 x 491	491	966300	20200	23000	39,37	256,6	59000	2796	4335	9,73	142,2	3441	122200	1	1	1	1	3	4	✓	HI	
HL 920 x 537	537	1066000	22080	25270	39,51	282,1	65550	3085	4795	9,80	152,9	4447	136900	1	1	1	1	2	3	✓	HI	
HL 920 x 588	588	1181000	24230	27840	39,74	309,3	72760	3408	5310	9,86	165,1	5860	153200	1	1	1	1	1	2	✓	HI	
HL 920 x 656	656	1335000	27060	31270	39,98	345,8	83040	3853	6022	9,97	180,8	7950	177600	1	1	1	1	1	2	✓	HI	
HL 920 x 725	725	1492000	29880	34740	40,21	383,6	93200	4295	6734	10,05	196,6	10570	201900	1	1	1	1	1	1	✓	HI	
HL 920 x 787	787	1646000	32560	38010	40,53	414,5	103300	4728	7425	10,15	211,0	13430	226800	1	1	1	1	1	1	✓	HI	
HL 920 x 970	970	2100000	40270	47660	41,21	513,8	133900	6002	9490	10,40	252,1	24320	304000	1	1	1	1	1	1	✓	HI	
HL 1000 AA·	296	620300	12630	14260	40,53	181,5	28960	1448	2243	8,76	105,8	762,6	65900	1	1	2	4	4	4	✓	HI	HI
HL 1000 A·	321	696400	14070	15800	41,27	184,6	33120	1656	2555	9,00	113,6	1021	76030	1	1	2	4	4	4	✓	HI	HI
HL 1000 B·	371	813700	16270	18360	41,49	212,5	38580	1929	2984	9,03	126,3	1575	89440	1	1	1	4	4	4	✓	HI	HI
HL 1000 M·	412	910500	18070	20460	41,64	236,0	43400	2160	3349	9,09	136,2	2134	101500	1	1	1	3	4	4	✓	HI	HI
HL 1000 x 443	443	966500	19100	21780	41,41	261,8	45500	2264	3529	8,98	142,5	2545	106700	1	1	1	2	4	4	✓	HI	
HL 1000 x 483	483	1067000	20930	23920	41,66	282,7	50710	2510	3919	9,08	152,5	3311	119900	1	1	1	2	4	4	✓	HI	
HL 1000 x 539	539	1203000	23350	26820	41,83	316,4	57630	2832	4436	9,16	165,7	4546	137600	1	1	1	1	2	4	✓	HI	

HI = HITAR®

○ Disponible únicamente en JR, JO.

◆ W_{pl} : para el diseño plástico la sección debe pertenecer a la clase 1 o 2 según la capacidad de rotación que se precise. Véase pág. 203.

○ Only available in JR, JO.

◆ W_{pl} : for plastic design, the shape must belong to class 1 or 2 according to the required rotation capacity. See page 203.

○ Disponibile solo come JR, JO.

◆ W_{pl} : per il calcolo plastico, la sezione trasversale deve appartenere alla classe 1 o 2, conformemente alla capacità di rotazione richiesta. Vedere pagina 203.

Perfiles H de alas muy anchas (continúa)

Dimensiones: ASTM A 6/A 6M - 07

Tolerancias: ASTM A 6/A 6M - 07

Estado de la superficie: conforme a norma EN 10163-3: 2004, clase C, subclase 1

European extra wide flange beams (continued)

Dimensiones: ASTM A 6/A 6M - 07

Tolerancias: ASTM A 6/A 6M - 07

Surface condition: according to EN 10163-3: 2004, class C, subclass 1

Profili H ad ali extra larghe (continua)

Dimensioni: ASTM A 6/A 6M - 07

Tolleranze: ASTM A 6/A 6M - 07

Condizioni di superficie: secondo EN 10163-3: 2004, classe C, sottoclasse 1

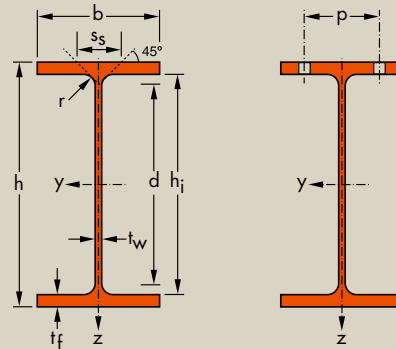

Denominación Designation Designazione	Dimensiones Dimensions Dimensioni						A	Dimensiones de construcción Dimensions for detailing Dimensioni di dettaglio					Superficie Surface Superficie	
	G	h	b	t _w	t _r	r		h _i	d	Ø	p _{min}	p _{max}	A _L	A _G
kg/m	mm	mm	mm	mm	mm	mm	mm ² x10 ²	mm	mm	mm	mm	mm	m ² /m	m ² /t
HL 1000 x 554*	554	1032	408	29,5	52,0	30	705,8	928,0	868,0	M 27	150	296	3,585	6,471
HL 1000 x 591*	591	1040	409	31,0	55,9	30	752,7	928,2	868,2	M 27	148	304	3,602	6,097
HL 1000 x 642*	642	1048	412	34,0	60,0	30	817,6	928,0	868,0	M 27	154	300	3,624	5,647
HL 1000 x 748*	748	1068	417	39,0	70,0	30	953,4	928,0	868,0	M 27	160	304	3,674	4,909
HL 1000 x 883*	883	1092	424	45,5	82,0	30	1125	928,0	868,0	M 27	166	312	3,737	4,231
HL 1100 A*	343	1090	400	18,0	31,0	20	436,5	1028	988,0	M 27	116	294	3,710	10,83
HL 1100 B*	390	1100	400	20,0	36,0	20	497,0	1028	988,0	M 27	118	294	3,726	9,549
HL 1100 M*	433	1108	402	22,0	40,0	20	551,2	1028	988,0	M 27	120	296	3,746	8,657
HL 1100 R*	499	1118	405	26,0	45,0	20	635,2	1028	988,0	M 27	124	300	3,770	7,560

* Pedido mínimo: para calidad S235 JR véanse condiciones de suministro en pág. 216; para cualquier otra calidad 40 t o según acuerdo.

* Tonelaje mínimo y condiciones de suministro previo acuerdo.

* Perfil conforme a ASTM A 6/A 6M - 03c

* Minimum order: for the S235 JR grade cf. delivery conditions page 216; for any other grade 40t or upon agreement.

* Minimum tonnage and delivery conditions upon agreement.

* Section in accordance with ASTM A 6/A 6M - 03c

* Ordine minimo: Per la qualità S235 JR vedere le condizioni di fornitura a pagina 216; per qualunque altra qualità: 40t o da concordare.

* Tonnellaggio minimo e condizioni di fornitura da concordare.

* Sezione secondo ASTM A 6/A 6M - 03c

Páginas de notaciones 199-203 / Notations pages 199-203 / Pagine di annotazioni 199-203

Denominación Designation Designazione	Propiedades del perfil / Section properties / Proprietà geometriche del profilo												Classification EN 1993-1-1: 2005						EN 10025-2: 2004	EN 10025-4: 2004	EN 10225:2001	
	eje fuerte y-y strong axis y-y asse forte y-y						eje débil z-z weak axis z-z asse debole z-z						Pure bending y-y			Pure compression						
	G	I_y	W_{ely}	$W_{ply} \blacklozenge$	i_y	A_{vz}	I_z	W_{elz}	$W_{plz} \blacklozenge$	i_z	s_s	I_t	I_w	S235	S355	S460	S235	S355				S460
kg/m	mm ⁴ x10 ⁴	mm ³ x10 ³	mm ³ x10 ³	mm x10	mm ² x10 ²	mm ⁴ x10 ⁴	mm ³ x10 ³	mm ³ x10 ³	mm x10	mm	mm ⁴ x10 ⁴	mm ⁶ x10 ⁹										
HL 1000 x 554	554	1232000	23880	27500	41,79	328,0	59100	2897	4547	9,15	168,6	4860	141300	1	1	1	1	2	3	✓	HI	
HL 1000 x 591	591	1331000	25600	29530	42,05	346,3	64010	3130	4916	9,22	177,9	5927	154300	1	1	1	1	2	3	✓	HI	
HL 1000 x 642	642	1451000	27680	32100	42,12	379,6	70280	3412	5379	9,27	189,1	7440	170700	1	1	1	1	1	2	✓	HI	
HL 1000 x 748	748	1732000	32430	37880	42,62	438,9	85110	4082	6459	9,45	214,1	11670	210600	1	1	1	1	1	1	✓	HI	
HL 1000 x 883	883	2096000	38390	45260	43,16	516,5	105000	4952	7874	9,66	244,6	18750	265700	1	1	-	1	1	-	○		
HL 1100 A	343	867400	15920	18060	44,58	206,5	33120	1656	2568	8,71	103,4	1037	92710	1	1	2	4	4	4	✓	HI	HI
HL 1100 B	390	1005000	18280	20780	44,98	230,6	38480	1924	2988	8,80	115,4	1564	108700	1	1	1	4	4	4	✓	HI	HI
HL 1100 M	433	1126000	20320	23160	45,19	254,4	43410	2160	3362	8,87	125,4	2130	123500	1	1	1	4	4	4	✓	HI	HI
HL 1100 R	499	1294000	23150	26600	45,14	300,4	49980	2468	3870	8,87	139,4	3135	143400	1	1	1	2	4	4	✓	HI	

HI = HSTAR®

○ Disponible únicamente en JR, JO.

◆ W_{pl} : para el diseño plástico la sección debe pertenecer a la clase 1 o 2 según la capacidad de rotación que se precise. Véase pág. 203.

○ Only available in JR, JO.

◆ W_{pl} : for plastic design, the shape must belong to class 1 or 2 according to the required rotation capacity. See page 203.

○ Disponibile solo come JR, JO.

◆ W_{pl} : per il calcolo plastico, la sezione trasversale deve appartenere alla classe 1 o 2, conformemente alla capacità di rotazione richiesta. Vedere pagina 203.

Perfiles H de alas anchas para pilares

Dimensiones: HD 360 / 400 conforme a ASTM A 6/A 6M - 07; HD 260, HD 320 conforme a la norma de fábrica

Tolerancias: EN 10034: 1993 HD 260/320

ASTM A 6/A 6M - 07 HD 360/400

Estado de la superficie: conforme a norma EN 10163-3: 2004, clase C, subclase 1

Wide flange columns

Dimensions: HD 360 / 400 in accordance with ASTM A 6/A 6M - 07; HD 260,

HD 320 in accordance with mill standard

Tolerances: EN 10034: 1993 HD 260/320

ASTM A 6/A 6M - 07 HD 360/400

Surface condition: according to EN 10163-3: 2004, class C, subclass 1

Profili H portanti a spessore maggiorato

Dimensioni: HD 360 / 400 secondo ASTM A 6/A 6M - 07; HD 260,

HD 320 secondo lo standard dell'acciaieria

Tolleranze: EN 10034: 1993 HD 260/320

ASTM A 6/A 6M - 07 HD 360/400

Condizioni di superficie: secondo EN 10163-3: 2004, classe C, sottoclasse 1

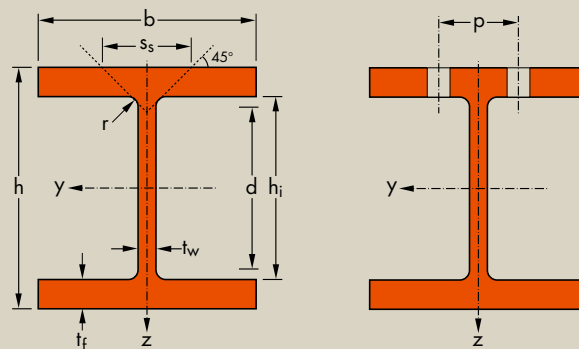

Denominación Designation Designazione	Dimensiones Dimensions Dimensioni						A mm ² x10 ²	Dimensiones de construcción Dimensions for detailing Dimensioni di dettaglio					Superficie Surface Superficie	
	G kg/m	h mm	b mm	t _w mm	t _f mm	r mm		h _i mm	d mm	Ø mm	p _{min} mm	p _{max} mm	A _L m ² /m	A _C m ² /t
HD 260 x 54,1 ^{*/}	54,1	244	260	6,5	9,5	24	69,0	225,0	177,0	M 27	110	158	1,474	27,22
HD 260 x 68,2 [*]	68,2	250	260	7,5	12,5	24	86,8	225,0	177,0	M 27	110	158	1,484	21,77
HD 260 x 93,0 [*]	93,0	260	260	10,0	17,5	24	118,4	225,0	177,0	M 27	114	158	1,499	16,12
HD 260 x 114 ^{*/}	114	268	262	12,5	21,5	24	145,7	225,0	177,0	M 27	116	160	1,518	13,27
HD 260 x 142 ^{*/}	142	278	265	15,5	26,5	24	180,3	225,0	177,0	M 27	120	164	1,544	10,91
HD 260 x 172 [*]	172	290	268	18,0	32,5	24	219,6	225,0	177,0	M 27	122	166	1,575	9,133
HD 320 x 74,2 ^{*/}	74,2	301	300	8,0	11,0	27	94,6	279,0	225,0	M 27	118	198	1,740	23,43
HD 320 x 97,6 [*]	97,6	310	300	9,0	15,5	27	124,4	279,0	225,0	M 27	118	198	1,756	17,98
HD 320 x 127 [*]	127	320	300	11,5	20,5	27	161,3	279,0	225,0	M 27	122	198	1,771	13,98
HD 320 x 158 ^{*/}	158	330	303	14,5	25,5	27	201,2	279,0	225,0	M 27	124	202	1,797	11,37
HD 320 x 198 ^{*/}	198	343	306	18,0	32,0	27	252,3	279,0	225,0	M 27	128	204	1,828	9,227
HD 320 x 245 [*]	245	359	309	21,0	40,0	27	312,0	279,0	225,0	M 27	132	204	1,866	7,616
HD 320 x 300 ^{*/}	300	375	313	27,0	48,0	27	382,1	279,0	225,0	M 27	138	208	1,902	6,340
HD 360 x 134 [*]	134	356	369	11,2	18,0	15	170,6	320,0	290,0	M 27	100	264	2,140	15,98
HD 360 x 147 [*]	147	360	370	12,3	19,8	15	187,9	320,4	290,4	M 27	100	264	2,150	14,58
HD 360 x 162 [*]	162	364	371	13,3	21,8	15	206,3	320,4	290,4	M 27	102	266	2,160	13,34
HD 360 x 179 [*]	179	368	373	15,0	23,9	15	228,3	320,2	290,2	M 27	104	268	2,172	12,12
HD 360 x 196 [*]	196	372	374	16,4	26,2	15	250,3	319,6	289,6	M 27	104	268	2,181	11,10

* Pedido mínimo: para calidad S235 JR véanse condiciones de suministro en pág. 216; para cualquier otra calidad 40 t o según acuerdo.

+ Pedido mínimo: 40 t por perfil y calidad o según acuerdo.

* Tonelaje mínimo y condiciones de suministro previo acuerdo.

* Minimum order: for the S235 JR grade cf. delivery conditions page 216; for any other grade 40t or upon agreement.

+ Minimum order: 40t per section and grade or upon agreement.

* Minimum tonnage and delivery conditions upon agreement.

* Ordine minimo: Per la qualità S235 JR vedere le condizioni di fornitura a pagina 216; per qualunque altra qualità: 40t o da concordare.

+ Ordine minimo: 40t per sezione e qualità o da concordare.

* Tonnellaggio minimo e condizioni di fornitura da concordare.

Páginas de notaciones 199-203 / Notations pages 199-203 / Pagine di annotazioni 199-203

Denominación Designation Designazione	Propiedades del perfil / Section properties / Proprietà geometriche del profilo													Classification EN 1993-1-1: 2005						EN 10025-2: 2004	EN 10025-4: 2004	EN 10225:2001
	G kg/m	eje fuerte y-y strong axis y-y asse forte y-y					eje débil z-z weak axis z-z asse debole z-z					Pure bending y-y			Pure compression							
		I_y mm ⁴ x10 ⁴	$W_{el,y}$ mm ³ x10 ³	$W_{pl,y}♦$ mm ³ x10 ³	i_y mm x10	A_{vz} mm ² x10 ²	I_z mm ⁴ x10 ⁴	$W_{el,z}$ mm ³ x10 ³	$W_{pl,z}♦$ mm ³ x10 ³	i_z mm x10	s_s mm	I_t mm ⁴ x10 ⁴	I_w mm ⁶ x10 ⁹	S235	S355	S460	S235	S355	S460			
HD 260 x 54,1	54,1	7981	654,1	714,5	10,76	24,75	2788	214,5	327,7	6,36	53,62	30,31	382,6	3	3	4	3	3	4	✓	✓	✓
HD 260 x 68,2	68,2	10450	836,4	919,8	10,97	28,76	3668	282,1	430,2	6,50	60,62	52,37	516,4	1	3	3	1	3	3	✓	HI	HI
HD 260 x 93,0	93,0	14920	1148	1283	11,22	37,59	5135	395,0	602,2	6,58	73,12	123,8	753,7	1	1	1	1	1	1	✓	HI	HI
HD 260 x 114	114	18910	1411	1600	11,39	46,08	6456	492,8	752,5	6,66	83,62	222,4	979,0	1	1	1	1	1	1	✓	HI	HI
HD 260 x 142	142	24330	1750	2015	11,62	56,65	8236	621,6	950,5	6,76	96,62	406,8	1300	1	1	1	1	1	1	✓	HI	HI
HD 260 x 172	172	31310	2159	2524	11,94	66,89	10450	779,7	1192	6,90	111,1	719,0	1728	1	1	1	1	1	1	✓	HI	HI
HD 320 x 74,2	74,2	16450	1093	1196	13,19	35,40	4959	330,6	505,7	7,24	61,63	55,87	1041	3	3	4	3	3	4	✓	✓	✓
HD 320 x 97,6	97,6	22930	1479	1628	13,58	41,13	6985	465,7	709,7	7,49	71,63	108,0	1512	1	2	3	1	2	3	✓	HI	HI
HD 320 x 127	127	30820	1926	2149	13,82	51,77	9239	615,9	939,1	7,57	84,13	225,1	2069	1	1	1	1	1	1	✓	HI	HI
HD 320 x 158	158	39640	2403	2718	14,04	64,18	11840	781,7	1194	7,67	97,13	420,5	2741	1	1	1	1	1	1	✓	HI	HI
HD 320 x 198	198	51900	3026	3479	14,34	79,52	15310	1001	1530	7,79	113,6	805,3	3695	1	1	1	1	1	1	✓	HI	HI
HD 320 x 245	245	68130	3796	4435	14,78	94,85	19710	1276	1951	7,95	132,6	1501	5004	1	1	1	1	1	1	✓	HI	HI
HD 320 x 300	300	86900	4635	5522	15,08	120,47	24600	1572	2414	8,02	154,6	2650	6558	1	1	1	1	1	1	✓	HI	HI
HD 360 x 134	134	41510	2332	2562	15,60	45,19	15080	817,3	1237	9,40	64,77	168,8	4305	2	3	3	2	3	3	✓	HI	HI
HD 360 x 147	147	46290	2572	2838	15,70	49,72	16720	903,9	1369	9,43	69,47	223,7	4836	1	3	3	1	3	3	✓	HI	HI
HD 360 x 162	162	51540	2832	3139	15,81	53,98	18560	1001	1516	9,49	74,47	295,5	5432	1	2	3	1	2	3	✓	HI	HI
HD 360 x 179	179	57440	3122	3482	15,86	60,72	20680	1109	1683	9,52	80,37	393,8	6119	1	1	2	1	1	2	✓	HI	HI
HD 360 x 196	196	63630	3421	3837	15,94	66,50	22860	1222	1856	9,56	86,37	517,1	6829	1	1	1	1	1	1	✓	HI	HI

HI = HISTAR®

♦ W_{pl} : para el diseño plástico la sección debe pertenecer a la clase 1 o 2 según la capacidad de rotación que se precise. Véase pág. 203.
 ♦ W_{pl} : for plastic design, the shape must belong to class 1 or 2 according to the required rotation capacity. See page 203.
 ♦ W_{pl} : per il calcolo plastico, la sezione trasversale deve appartenere alla classe 1 o 2, conformemente alla capacità di rotazione richiesta. Vedere pagina 203.

Perfiles H de alas anchas para pilares (continúa)

Dimensiones: HD 360 / 400 conforme a ASTM A 6/A 6M - 07; HD 260, HD 320 conforme a la norma de fábrica
Tolerancias: EN 10034: 1993 HD 260/320
ASTM A 6/A 6M - 07 HD 360/400
Estado de la superficie: conforme a norma EN 10163-3: 2004, clase C, subclase 1

Wide flange columns (continued)

Dimensions: HD 360 / 400 in accordance with ASTM A 6/A 6M - 07; HD 260, HD 320 in accordance with mill standard
Tolerances: EN 10034: 1993 HD 260/320
ASTM A 6/A 6M - 07 HD 360/400
Surface condition: according to EN 10163-3: 2004, class C, subclass 1

Profili H portanti a spessore maggiorato (continua)

Dimensioni: HD 360 / 400 secondo ASTM A 6/A 6M - 07; HD 260, HD 320 secondo lo standard dell'acciaiera
Tolleranze: EN 10034: 1993 HD 260/320
ASTM A 6/A 6M - 07 HD 360/400
Condizioni di superficie: secondo EN 10163-3: 2004, classe C, sottoclasse 1

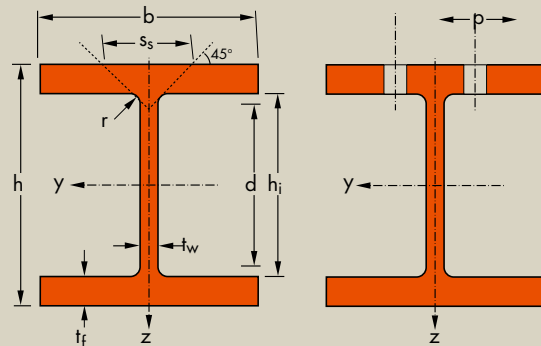

Denominación Designation Designazione	Dimensiones Dimensions Dimensioni						A mm ² x10 ²	Dimensiones de construcción Dimensions for detailing Dimensioni di dettaglio					Superficie Surface Superficie	
	G kg/m	h mm	b mm	t _w mm	t _f mm	r mm		h _i mm	d mm	Ø mm	p _{min} mm	p _{max} mm	A _L m ² /m	A _C m ² /t
HD 400 x 187*	187	368	391	15,0	24,0	15	237,6	320,0	290,0	M 27	104	286	2,244	12,03
HD 400 x 216·/*	216	375	394	17,3	27,7	15	275,5	319,6	289,6	M 27	106	288	2,266	10,48
HD 400 x 237·/*	237	380	395	18,9	30,2	15	300,9	319,6	289,6	M 27	108	290	2,276	9,637
HD 400 x 262·/*	262	387	398	21,1	33,3	15	334,6	320,4	290,4	M 27	110	292	2,298	8,749
HD 400 x 287·/*	287	393	399	22,6	36,6	15	366,3	319,8	289,8	M 27	112	294	2,311	8,038
HD 400 x 314·/*	314	399	401	24,9	39,6	15	399,2	319,8	289,8	M 27	114	296	2,326	7,425
HD 400 x 347·/*	347	407	404	27,2	43,7	15	442,0	319,6	289,6	M 27	116	298	2,350	6,773
HD 400 x 382·/*	382	416	406	29,8	48,0	15	487,1	320,0	290,0	M 27	118	300	2,371	6,200
HD 400 x 421·/*	421	425	409	32,8	52,6	15	537,1	319,8	289,8	M 27	122	304	2,395	5,680
HD 400 x 463·/*	463	435	412	35,8	57,4	15	589,5	320,2	290,2	M 27	124	306	2,421	5,231
HD 400 x 509·/*	509	446	416	39,1	62,7	15	649,0	320,6	290,6	M 27	128	310	2,452	4,813
HD 400 x 551·/*	551	455	418	42,0	67,6	15	701,4	319,8	289,8	M 27	132	312	2,472	4,490
HD 400 x 592·/*	592	465	421	45,0	72,3	15	754,9	320,4	290,4	M 27	134	316	2,498	4,216
HD 400 x 634·/*	634	474	424	47,6	77,1	15	808,0	319,8	289,8	M 27	140	312	2,523	3,978
HD 400 x 677·/*	677	483	428	51,2	81,5	15	863,4	320,0	290,0	M 27	144	316	2,550	3,762
HD 400 x 744·/*	744	498	432	55,6	88,9	15	948,1	320,2	290,2	M 27	148	320	2,587	3,476
HD 400 x 818·/*	818	514	437	60,5	97,0	15	1043	320,0	290,0	M 27	154	326	2,629	3,210
HD 400 x 900·/*	900	531	442	65,9	106	15	1149	319,0	289,0	M 27	158	330	2,672	2,962
HD 400 x 990·/*	990	550	448	71,9	115	15	1262	320,0	290,0	M 27	164	336	2,722	2,747
HD 400 x 1086·/*	1086	569	454	78,0	125	15	1386	319,0	289,0	M 27	170	342	2,772	2,548

* Pedido mínimo: para calidad S235 JR véanse condiciones de suministro en pág. 216; para cualquier otra calidad 40 t o según acuerdo.

+ Pedido mínimo: 40 t por perfil y calidad o según acuerdo.

* Tonelaje mínimo y condiciones de suministro previo acuerdo.

* Minimum order: for the S235 JR grade cf. delivery conditions page 216; for any other grade 40t or upon agreement.

+ Minimum order: 40t per section and grade or upon agreement.

* Minimum tonnage and delivery conditions upon agreement.

* Ordine minimo: Per la qualità S235 JR vedere le condizioni di fornitura a pagina 216; per qualunque altra qualità: 40t o da concordare.

+ Ordine minimo: 40t per sezione e qualità o da concordare.

* Tonnellaggio minimo e condizioni di fornitura da concordare.

Páginas de notaciones 199-203 / Notations pages 199-203 / Pagine di annotazioni 199-203

Denominación Designation Designazione	Propiedades del perfil / Section properties / Proprietà geometriche del profilo													Classification EN 1993-1-1: 2005						EN 10025-2: 2004	EN 10025-4: 2004	EN 10225:2001
	G kg/m	eje fuerte y-y strong axis y-y asse forte y-y					eje débil z-z weak axis z-z asse debole z-z					Pure bending y-y			Pure compression							
		I_y mm ⁴ x10 ⁴	$W_{el,y}$ mm ³ x10 ³	$W_{pl,y}♦$ mm ³ x10 ³	i_y mm x10	A_{vz} mm ² x10 ²	I_z mm ⁴ x10 ⁴	$W_{el,z}$ mm ³ x10 ³	$W_{pl,z}♦$ mm ³ x10 ³	i_z mm x10	s_s mm	I_t mm ⁴ x10 ⁴	I_w mm ⁶ x10 ⁹	S235	S355	S460	S235	S355	S460			
HD 400 x 187	187	60180	3271	3642	15,91	60,73	23920	1224	1855	10,03	80,57	414,6	7074	1	1	3	1	1	3	✓	HI	HI
HD 400 x 216	216	71140	3794	4262	16,07	70,32	28250	1434	2176	10,13	90,27	637,3	8515	1	1	1	1	1	1	✓	HI	HI
HD 400 x 237	237	78780	4146	4686	16,18	77,10	31040	1572	2387	10,16	96,87	825,5	9489	1	1	1	1	1	1	✓	HI	HI
HD 400 x 262	262	89410	4620	5260	16,35	86,55	35020	1760	2676	10,23	105,3	1116	10940	1	1	1	1	1	1	✓	HI	HI
HD 400 x 287	287	99710	5074	5813	16,50	93,46	38780	1944	2957	10,29	113,4	1464	12300	1	1	1	1	1	1	✓	HI	HI
HD 400 x 314	314	110200	5525	6374	16,62	103,3	42600	2125	3236	10,33	121,7	1870	13740	1	1	1	1	1	1	✓	HI	HI
HD 400 x 347	347	124900	6140	7139	16,81	113,9	48090	2380	3629	10,43	132,2	2510	15850	1	1	1	1	1	1	✓	HI	
HD 400 x 382	382	141300	6794	7965	17,03	126,0	53620	2641	4031	10,49	143,4	3326	18130	1	1	1	1	1	1	✓	HI	
HD 400 x 421	421	159600	7510	8880	17,24	139,9	60080	2938	4489	10,58	155,6	4398	20800	1	1	1	1	1	1	✓	HI	
HD 400 x 463	463	180200	8283	9878	17,48	154,3	67040	3254	4978	10,66	168,2	5735	23850	1	1	1	1	1	1	✓	HI	
HD 400 x 509	509	204500	9172	11030	17,75	170,6	75400	3625	5552	10,78	182,1	7513	27630	1	1	1	1	1	1	✓	HI	
HD 400 x 551	551	226100	9939	12050	17,95	184,9	82490	3947	6051	10,85	194,8	9410	30870	1	1	1	1	1	1	✓	HI	
HD 400 x 592	592	250200	10760	13140	18,20	200,3	90170	4284	6574	10,93	207,2	11560	34670	1	1	1	1	1	1	✓	HI	
HD 400 x 634	634	274200	11570	14220	18,42	214,0	98250	4634	7117	11,03	219,4	14020	38570	1	1	1	1	1	1	✓	HI	
HD 400 x 677	677	299500	12400	15350	18,62	231,9	106900	4994	7680	11,13	231,8	16790	42920	1	1	1	1	1	1	✓	HI	
HD 400 x 744	744	342100	13740	17170	19,00	256,1	119900	5552	8549	11,25	251,0	21840	49980	1	1	1	1	1	1	✓	HI	
HD 400 x 818	818	392200	15260	19260	19,39	283,3	135500	6203	9561	11,40	272,1	28510	58650	1	1	1	1	1	1	✓	HI	
HD 400 x 900	900	450200	16960	21620	19,79	313,8	153300	6938	10710	11,55	295,5	37350	68890	1	1	1	1	1	1	✓	HI	
HD 400 x 990	990	518900	18870	24280	20,27	349,2	173400	7739	11960	11,72	319,5	48210	81530	1	1	1	1	1	1	✓	HI	
HD 400 x 1086	1086	595700	20940	27210	20,73	385,8	196200	8645	13380	11,90	345,6	62290	96080	1	1	1	1	1	1	✓	HI	

HI = HISTAR®

♦ W_{pl} : para el diseño plástico la sección debe pertenecer a la clase 1 o 2 según la capacidad de rotación que se precise. Véase pág. 203.
 ♦ W_{pl} : for plastic design, the shape must belong to class 1 or 2 according to the required rotation capacity. See page 203.
 ♦ W_{pl} : per il calcolo plastico, la sezione trasversale deve appartenere alla classe 1 o 2, conformemente alla capacità di rotazione richiesta. Vedere pagina 203.

Perfiles H de alas anchas para pilotes

Dimensiones: conforme a la norma de fábrica

Tolerancias: EN 10034: 1993

Estado de la superficie: conforme a norma EN 10163-3: 2004, clase C, subclase 1

Wide flange bearing piles

Dimensions: in accordance with mill standard

Tolerances: EN 10034: 1993

Surface condition: according to EN 10163-3: 2004, class C, subclass 1

Profili H portanti ad ali extra larghe

Dimensioni: secondo lo standard dell'acciaieria

Tolleranze: EN 10034: 1993

Condizioni di superficie: secondo EN 10163-3: 2004, classe C, sottoclasse 1

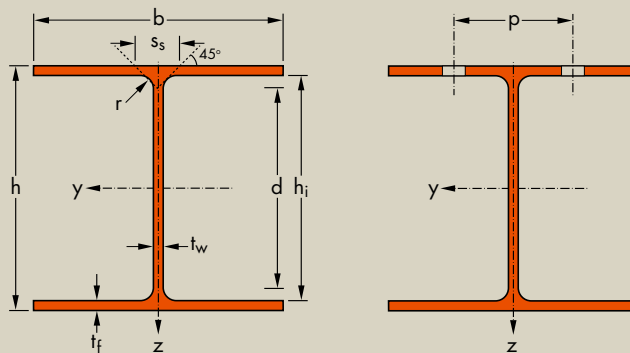

Denominación Designation Designazione	Dimensiones Dimensions Dimensioni						A mm ² x10 ²	Dimensiones de construcción Dimensions for detailing Dimensioni di dettaglio					Superficie Surface Superficie	
	G kg/m	h mm	b mm	t _w mm	t _f mm	r mm		h _i mm	d mm	Ø	p _{min} mm	p _{max} mm	A _L m ² /m	A _C m ² /t
HP 200 x 43*/*	42,5	200,0	205,0	9,0	9,0	10,0	54,1	182,0	162,0	M 27	100	106	1,185	27,88
HP 200 x 53*/*	53,5	204,0	207,0	11,3	11,3	10,0	68,4	181,4	161,4	M 27	104	108	1,196	22,36
HP 220 x 57*/*	57,2	210,0	224,5	11,0	11,0	18,0	72,9	188,0	152,0	M 27	102	122	1,265	22,12
HP 260 x 75*/*	75,0	249,0	265,0	12,0	12,0	24,0	95,5	225,0	177,0	M 27	116	164	1,493	19,90
HP 260 x 87*/*	87,3	253,0	267,0	14,0	14,0	24,0	111	225,0	177,0	M 27	118	166	1,505	17,24
HP 305 x 79*	78,9	299,3	306,4	11,0	11,1	15,2	101	277,1	246,7	M 27	102	204	1,776	22,52
HP 305 x 88*	88,0	301,7	307,8	12,4	12,3	15,2	112	277,1	246,7	M 27	104	206	1,784	20,28
HP 305 x 95*	94,9	303,7	308,7	13,3	13,3	15,2	121	277,1	246,7	M 27	106	206	1,790	18,85
HP 305 x 110*	110	307,9	310,7	15,3	15,4	15,2	140	277,1	246,7	M 27	108	208	1,802	16,39
HP 305 x 126*	126	312,3	312,9	17,5	17,6	15,2	161	277,1	246,7	M 27	110	210	1,815	14,40
HP 305 x 149*	149	318,5	316,0	20,6	20,7	15,2	190	277,1	246,7	M 27	114	214	1,834	12,30
HP 305 x 180*	180	326,7	319,7	24,8	24,8	15,2	229	277,1	246,7	M 27	118	218	1,857	10,31
HP 305 x 186*	186	328,3	320,9	25,5	25,6	15,2	237	277,1	246,7	M 27	118	218	1,863	10,02
HP 305 x 223*	223	337,9	325,7	30,3	30,4	15,2	284	277,1	246,7	M 27	124	220	1,892	8,487
HP 320 x 88*/*	88,5	303,0	304,0	12,0	12,0	27,0	113	279,0	225,0	M 27	122	202	1,752	19,80
HP 320 x 103*/*	103	307,0	306,0	14,0	14,0	27,0	131	279,0	225,0	M 27	124	204	1,764	17,15
HP 320 x 117*/*	117	311,0	308,0	16,0	16,0	27,0	150	279,0	225,0	M 27	126	206	1,776	15,13
HP 320 x 147*/*	147	319,0	312,0	20,0	20,0	27,0	187	279,0	225,0	M 27	130	210	1,800	12,27
HP 320 x 184*/*	184	329,0	317,0	25,0	25,0	27,0	235	279,0	225,0	M 27	136	216	1,830	9,939
HP 360 x 109*	109	346,4	371,0	12,8	12,9	15,2	139	320,6	290,2	M 27	102	266	2,125	19,51
HP 360 x 133*	133	352,0	373,8	15,6	15,7	15,2	169	320,6	290,2	M 27	104	268	2,142	16,11
HP 360 x 152*	152	356,4	376,0	17,8	17,9	15,2	194	320,6	290,2	M 27	106	270	2,155	14,18
HP 360 x 174*	174	361,4	378,5	20,3	20,4	15,2	222	320,6	290,2	M 27	110	272	2,170	12,48
HP 360 x 180*	180	362,9	378,8	21,1	21,1	15,2	230	320,7	290,3	M 27	110	272	2,173	12,06

+ Pedido mínimo: 40 t por perfil y calidad o según acuerdo.
* Tonelaje mínimo y condiciones de suministro previo acuerdo.

+ Minimum order: 40t per section and grade or upon agreement.
* Minimum tonnage and delivery conditions upon agreement.

+ Ordine minimo: 40t per sezione e qualità o da concordare.
* Tonnellaggio minimo e condizioni di fornitura da concordare.

Páginas de notaciones 199-203 / Notations pages 199-203 / Pagine di annotazioni 199-203

Denominación Designation Designazione	Propiedades del perfil / Section properties / Proprietà geometriche del profilo												Classification EN 1993-1-1: 2005						EN 10025-2: 2004	EN 10025-4: 2004	EN 10225:2001	
	G kg/m	eje fuerte y-y strong axis y-y asse forte y-y					eje débil z-z weak axis z-z asse debole z-z					Pure bending y-y			Pure compression							
		I_y mm ⁴ x10 ⁴	W_{ely} mm ³ x10 ³	W_{ply} ♦ mm ³ x10 ³	i_y mm x10	A_{vz} mm ² x10 ²	I_z mm ⁴ x10 ⁴	W_{elz} mm ³ x10 ³	W_{plz} ♦ mm ³ x10 ³	i_z mm x10	s_s mm	I_t mm ⁴ x10 ⁴	I_w mm ⁶ x10 ⁹	S235	S355	S460	S235	S355				S460
HP 200 x 43	42,5	3888	388,8	434,5	8,47	19,85	1294	126,2	193,4	4,89	38,72	17,68	117,9	2	3	4	2	3	4	✓	✓	
HP 200 x 53	53,5	4977	488,0	551,3	8,55	24,89	1673	161,7	248,6	4,96	45,62	34,20	155,1	1	2	3	1	2	3	✓	✓	
HP 220 x 57	57,2	5729	545,6	613,7	8,87	28,63	2079	185,2	285,5	5,34	54,09	44,18	205,4	1	2	3	1	2	3	✓	✓	✓
HP 260 x 75	75,0	10650	855,1	958,5	10,56	39,14	3733	281,7	435,1	6,25	64,12	79,29	522,6	1	3	3	1	3	3	✓	✓	✓
HP 260 x 87	87,3	12590	994,9	1124	10,64	45,12	4455	333,7	516,2	6,33	70,12	115,7	634,2	1	1	3	1	1	3	✓	✓	✓
HP 305 x 79	78,9	16440	1099	1218	12,79	37,06	5326	347,7	531,2	7,28	51,01	51,37	1105	3	4	4	3	4	4	✓	✓	✓
HP 305 x 88	88,0	18420	1221	1360	12,82	41,61	5984	388,9	595,2	7,31	54,81	70,05	1252	3	3	4	3	3	4	✓	✓	✓
HP 305 x 95	94,9	20040	1320	1474	12,87	44,65	6529	423,0	648,0	7,35	57,71	86,69	1375	2	3	3	2	3	3	✓	✓	✓
HP 305 x 110	110	23560	1531	1720	12,97	51,42	7709	496,2	761,7	7,42	63,91	131,4	1647	1	3	3	1	3	3	✓	HI	HI
HP 305 x 126	126	27410	1755	1986	13,06	58,91	9002	575,4	885,2	7,49	70,51	194,3	1951	1	2	3	1	2	3	✓	HI	HI
HP 305 x 149	149	33070	2076	2370	13,20	69,62	10910	690,5	1066	7,58	79,81	314,2	2414	1	1	1	1	1	1	✓	HI	HI
HP 305 x 180	180	40970	2508	2897	13,37	84,39	13550	847,4	1313	7,69	92,21	541,7	3077	1	1	1	1	1	1	✓	HI	HI
HP 305 x 186	186	42610	2596	3003	13,41	86,95	14140	881,5	1366	7,73	94,51	593,7	3230	1	1	1	1	1	1	✓	HI	HI
HP 305 x 223	223	52700	3119	3653	13,62	104,4	17580	1079	1680	7,87	108,9	998,4	4138	1	1	1	1	1	1	✓	HI	HI
HP 320 x 88	88,5	18740	1237	1379	12,90	47,66	5634	370,6	572,1	7,07	67,60	99,04	1190	2	3	3	2	3	3	✓	✓	✓
HP 320 x 103	103	22050	1437	1611	12,97	54,84	6704	438,2	677,3	7,15	73,60	142,3	1435	1	3	3	1	3	3	✓	HI	HI
HP 320 x 117	117	25480	1638	1849	13,06	62,10	7815	507,5	785,5	7,23	79,60	198,5	1695	1	2	3	1	2	3	✓	HI	HI
HP 320 x 147	147	32670	2048	2338	13,22	76,86	10160	651,3	1011	7,37	91,60	357,1	2263	1	1	1	1	1	1	✓	HI	HI
HP 320 x 184	184	42340	2574	2979	13,44	95,76	13330	841,2	1311	7,54	106,6	662,0	3067	1	1	1	1	1	1	✓	HI	HI
HP 360 x 109	109	30630	1769	1956	14,86	48,59	10990	592,3	902,9	8,90	56,41	90,73	3053	3	4	4	3	4	4	✓	✓	✓
HP 360 x 133	133	37980	2158	2406	14,98	59,22	13680	731,9	1119	8,99	64,81	160,7	3864	3	3	4	3	3	4	✓	HI	HI
HP 360 x 152	152	43970	2468	2767	15,07	67,68	15880	844,5	1293	9,05	71,41	236,4	4543	2	3	3	2	3	3	✓	HI	HI
HP 360 x 174	174	51010	2823	3186	15,18	77,41	18460	975,6	1497	9,13	78,91	348,5	5360	1	2	3	1	2	3	✓	HI	HI
HP 360 x 180	180	53040	2923	3306	15,20	80,52	19140	1011	1552	9,13	81,11	387,2	5583	1	2	3	1	2	3	✓	HI	HI

HI = HISTAR®

♦ W_{pl} : para el diseño plástico la sección debe pertenecer a la clase 1 o 2 según la capacidad de rotación que se precise. Véase pág. 203.
 ♦ W_{pl} : for plastic design, the shape must belong to class 1 or 2 according to the required rotation capacity. See page 203.
 ♦ W_{pl} : per il calcolo plastico, la sezione trasversale deve appartenere alla classe 1 o 2, conformemente alla capacità di rotazione richiesta. Vedere pagina 203.

Perfiles H de alas anchas para pilotes (continúa)

Dimensiones: conforme a la norma de fábrica

Tolerancias: EN 10034: 1993

Estado de la superficie: conforme a norma EN 10163-3: 2004, clase C, subclase 1

Wide flange bearing piles (continued)

Dimensions: in accordance with mill standard

Tolerances: EN 10034: 1993

Surface condition: according to EN 10163-3: 2004, class C, subclass 1

Profili H portanti ad ali extra larghe (continua)

Dimensioni: secondo lo standard dell'acciaieria

Tolleranze: EN 10034: 1993

Condizioni di superficie: secondo EN 10163-3: 2004, classe C, sottoclasse 1

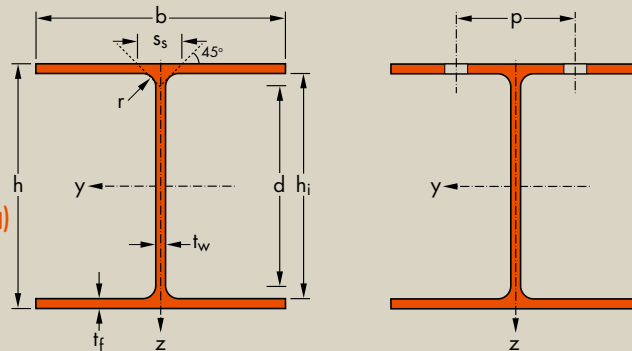

Denominación Designation Designazione	Dimensiones Dimensions Dimensioni						A mm ² x10 ²	Dimensiones de construcción Dimensions for detailing Dimensioni di dettaglio					Superficie Surface Superficie	
	h mm	b mm	t _w mm	t _f mm	r mm	h _i mm		d mm	Ø	p _{min} mm	p _{max} mm	A _L m ² /m	A _G m ² /t	
G kg/m														
HP 400 x 122 ⁺	122	348,0	390,0	14,0	14,0	15,0	156	320,0	290,0	M 27	102	284	2,202	17,99
HP 400 x 140 ⁺	140	352,0	392,0	16,0	16,0	15,0	179	320,0	290,0	M 27	104	286	2,214	15,80
HP 400 x 158 ⁺	158	356,0	394,0	18,0	18,0	15,0	201	320,0	290,0	M 27	106	288	2,226	14,08
HP 400 x 176 ⁺	176	360,0	396,0	20,0	20,0	15,0	224	320,0	290,0	M 27	108	290	2,238	12,71
HP 400 x 194 ⁺	194	364,0	398,0	22,0	22,0	15,0	248	320,0	290,0	M 27	110	292	2,250	11,58
HP 400 x 213 ⁺	213	368,0	400,0	24,0	24,0	15,0	271	320,0	290,0	M 27	112	294	2,262	10,64
HP 400 x 231 ⁺	231	372,0	402,0	26,0	26,0	15,0	294	320,0	290,0	M 27	114	296	2,274	9,848

- + Pedido mínimo: 40 t por perfil y calidad o según acuerdo.
- + Minimum order: 40t per section and grade or upon agreement.
- + Ordine minimo: 40t per sezione e qualità o da concordare.

Páginas de notaciones 199-203 / Notations pages 199-203 / Pagine di annotazioni 199-203

Denominación Designation Designazione	Propiedades del perfil / Section properties / Proprietà geometriche del profilo												Classification EN 1993-1-1: 2005						EN 10025-2: 2004	EN 10025-4: 2004	EN 10225:2001	
	eje fuerte y-y strong axis y-y asse forte y-y						eje débil z-z weak axis z-z asse debole z-z						Pure bending y-y			Pure compression						
	G	I_y	$W_{el,y}$	$W_{pl,y} \blacklozenge$	i_y	A_{vz}	I_z	$W_{el,z}$	$W_{pl,z} \blacklozenge$	i_z	s_s	I_t	I_w	S235	S355	S460	S235	S355				S460
kg/m	mm ⁴ x10 ⁴	mm ³ x10 ³	mm ³ x10 ³	mm x10	mm ² x10 ²	mm ⁴ x10 ⁴	mm ³ x10 ³	mm ³ x10 ³	mm x10	mm	mm ⁴ x10 ⁴	mm ⁶ x10 ⁹										
HP 400 x 122	122	34770	1998	2212	14,93	52,89	13850	710,3	1082	9,42	59,57	118,7	3860	3	4	4	3	4	4	✓	✓	✓
HP 400 x 140	140	40270	2288	2547	15,02	60,49	16080	820,2	1252	9,49	65,57	175,3	4534	3	3	4	3	3	4	✓	HI	HI
HP 400 x 158	158	45940	2581	2888	15,10	68,17	18370	932,4	1425	9,55	71,57	248,0	5241	2	3	3	2	3	3	✓	HI	HI
HP 400 x 176	176	51770	2876	3235	15,19	75,93	20720	1047	1603	9,61	77,57	338,9	5982	1	3	3	1	3	3	✓	HI	HI
HP 400 x 194	194	57760	3174	3588	15,28	83,77	23150	1163	1784	9,67	83,57	450,2	6759	1	2	3	1	2	3	✓	HI	HI
HP 400 x 213	213	63920	3474	3947	15,37	91,69	25640	1282	1969	9,73	89,57	584,2	7574	1	1	3	1	1	3	✓	HI	HI
HP 400 x 231	231	70260	3777	4312	15,45	99,69	28200	1403	2158	9,79	95,57	743,1	8425	1	1	2	1	1	2	✓	HI	HI

HI = HISTAR®

\blacklozenge W_{pl} : para el diseño plástico la sección debe pertenecer a la clase 1 o 2 según la capacidad de rotación que se precise. Véase pág. 203.
 \blacklozenge W_{pl} : for plastic design, the shape must belong to class 1 or 2 according to the required rotation capacity. See page 203.
 \blacklozenge W_{pl} : per il calcolo plástico, la sezione trasversale deve appartenere alla classe 1 o 2, conformemente alla capacità di rotazione richiesta. Vedere pagina 203.

Perfiles U de alas paralelas

Dimensiones: DIN 1026-2: 2002-10

Tolerancias: EN 10279: 2000

Estado de la superficie: conforme a norma EN 10163-3: 2004, clase C, subclase 1

Channels with parallel flanges

Dimensions: DIN 1026-2: 2002-10

Tolerances: EN 10279: 2000

Surface condition: according to EN 10163-3: 2004, class C, subclass 1

Profili U ad ali paralele

Dimensioni: DIN 1026-2: 2002-10

Tolleranze: EN 10279: 2000

Condizioni di superficie: secondo EN 10163-3: 2004, classe C, sottoclasse 1

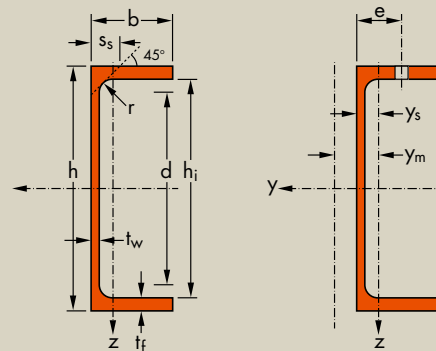

Denominación Designation Designazione	Dimensiones Dimensions Dimensioni						A mm ² x10 ²	Dimensiones de construcción Dimensions for detailing Dimensioni di dettaglio					Superficie Surface Superficie	
	h mm	b mm	t _w mm	t _r mm	r mm	h _i mm		d mm	Ø	e _{min} mm	e _{max} mm	A _L m ² /m	A _G m ² /t	
G kg/m														
UPE 80*	7,90	80	50	4,0	7,0	10	10,1	66	46	-	-	-	0,343	43,45
UPE 100*	9,82	100	55	4,5	7,5	10	12,5	85	65	M 12	35	36	0,402	41,00
UPE 120*	12,1	120	60	5,0	8,0	12	15,4	104	80	M 12	35	41	0,460	37,98
UPE 140*	14,5	140	65	5,0	9,0	12	18,4	122	98	M 16	35	38	0,520	35,95
UPE 160*	17,0	160	70	5,5	9,5	12	21,7	141	117	M 16	36	43	0,579	34,01
UPE 180*	19,7	180	75	5,5	10,5	12	25,1	159	135	M 16	36	48	0,639	32,40
UPE 200*	22,8	200	80	6,0	11,0	13	29,0	178	152	M 20	46	47	0,697	30,60
UPE 220*	26,6	220	85	6,5	12,0	13	33,9	196	170	M 22	47	49	0,756	28,43
UPE 240*	30,2	240	90	7,0	12,5	15	38,5	215	185	M 24	47	51	0,813	26,89
UPE 270*	35,2	270	95	7,5	13,5	15	44,8	243	213	M 27	48	50	0,892	25,34
UPE 300*	44,4	300	100	9,5	15,0	15	56,6	270	240	M 27	50	55	0,968	21,78
UPE 330*	53,2	330	105	11,0	16,0	18	67,8	298	262	M 27	54	60	1,043	19,60
UPE 360*	61,2	360	110	12,0	17,0	18	77,9	326	290	M 27	55	65	1,121	18,32
UPE 400*	72,2	400	115	13,5	18,0	18	91,9	364	328	M 27	57	70	1,218	16,87

* Tonelaje mínimo y condiciones de suministro previo acuerdo.

* Minimum tonnage and delivery conditions upon agreement.

* Tonnellaggio minimo e condizioni di fornitura da concordare.

Páginas de notaciones 199-203 / Notations pages 199-203 / Pagine di annotazioni 199-203

Denominación Designation Designazione	Propiedades del perfil / Section properties / Proprietà geometriche del profilo														Classification EN 1993-1-1: 2005				EN 10025-2: 2004	EN 10025-4: 2004	EN 10225:2001	
	eje fuerte y-y strong axis y-y asse forte y-y						eje débil z-z weak axis z-z asse debole z-z					Pure bending y-y		Pure compression								
	G	I_y	$W_{el,y}$	W_{ply} ■	i_y	A_{vz}	I_z	$W_{el,z}$	$W_{pl,z}$	i_z	s_s	I_t	I_w	y_s	y_m	S235	S355	S235				S355
kg/m	mm ⁴ x10 ⁴	mm ³ x10 ³	mm ³ x10 ³	mm x10	mm ² x10 ²	mm ⁴ x10 ⁴	mm ³ x10 ³	mm ³ x10 ³	mm x10	mm	mm ⁴ x10 ⁴	mm ⁶ x10 ⁹	mm x10	mm x10								
UPE 80	7,90	107	26,8	31,2	3,26	4,05	25,5	8,0	14,3	1,59	16,9	1,47	0,22	1,82	3,71	1	1	1	1	✓		
UPE 100	9,82	207	41,4	48,0	4,07	5,34	38,3	10,6	19,3	1,75	17,9	2,01	0,53	1,91	3,93	1	1	1	1	✓		
UPE 120	12,1	364	60,6	70,3	4,86	7,18	55,5	13,8	25,3	1,90	20,0	2,90	1,12	1,98	4,12	1	1	1	1	✓		
UPE 140	14,5	600	85,6	98,8	5,71	8,25	78,8	18,2	33,2	2,07	21,0	4,05	2,20	2,17	4,54	1	1	1	1	✓		
UPE 160	17,0	911	114	132	6,48	10,0	107	22,6	41,5	2,22	22,0	5,20	3,96	2,27	4,76	1	1	1	1	✓		
UPE 180	19,7	1350	150	173	7,34	11,2	144	28,6	52,3	2,39	23,0	6,99	6,81	2,47	5,19	1	1	1	1	✓		
UPE 200	22,8	1910	191	220	8,11	13,5	187	34,5	63,3	2,54	24,6	8,89	11,0	2,56	5,41	1	1	1	1	✓		
UPE 220	26,6	2680	244	281	8,90	15,8	247	42,5	78,2	2,70	26,1	12,1	17,6	2,70	5,70	1	1	1	1	✓		
UPE 240	30,2	3600	300	347	9,67	18,8	311	50,1	92,2	2,84	28,3	15,1	26,4	2,79	5,91	1	1	1	1	✓		
UPE 270	35,2	5250	389	451	10,8	22,2	401	60,7	112	2,99	29,8	19,9	43,6	2,89	6,14	1	1	1	2	✓		
UPE 300	44,4	7820	522	613	11,8	30,3	538	75,6	137	3,08	33,3	31,5	72,7	2,89	6,03	1	1	1	1	✓		
UPE 330	53,2	11010	667	792	12,7	38,8	681	89,7	156	3,17	37,5	45,2	112	2,90	6,00	1	1	1	1	✓		
UPE 360	61,2	14830	824	982	13,8	45,6	844	105	178	3,29	39,5	58,5	166	2,97	6,12	1	1	1	1	✓		
UPE 400	72,2	20980	1050	1260	15,1	56,2	1045	123	191	3,37	42,0	79,1	259	2,98	6,06	1	1	1	1	✓		

- W_{ply} se calcula según la hipótesis de un diagrama de tensiones birrectangular y sólo será aplicable cuando dos o más perfiles de sección en U estén combinados de tal manera que constituyan una sección doblemente simétrica, de tal modo que el momento de flexión que actúa en el plano del centro de gravedad no produzca torsión alguna.
- W_{ply} is determined assuming a bi-rectangular stress block distribution. Thus, the given value applies only if two or more channels are combined in such a way to form a double symmetric cross-section so that the bending moment acting in the plane of the centre of gravity will not lead to torsion.
- W_{ply} viene determinado presupponendo un diagramma delle sollecitazioni bi-rettangolare. Pertanto il valore dato vale unicamente se due o più sezioni a U vengono combinate in modo tale da formare una sezione doppiamente simmetrica cosicché il momento flettente che agisce nel piano del centro di gravità non produce torsione.

Perfiles U de alas inclinadas

Dimensiones: DIN 1026-1: 2000, NF A 45-202: 1986

Tolerancias: EN 10279: 2000

Estado de la superficie: conforme a norma EN 10163-3: 2004, clase C, subclase 1

European standard channels

Dimensions: DIN 1026-1: 2000, NF A 45-202: 1986

Tolerances: EN 10279: 2000

Surface condition: according to EN 10163-3: 2004, class C, subclass 1

Profili U ad ali inclinate

Dimensioni: DIN 1026-1: 2000, NF A 45-202: 1986

Tolleranze: EN 10279: 2000

Condizioni di superficie: secondo EN 10163-3: 2004, classe C, sottoclasse 1

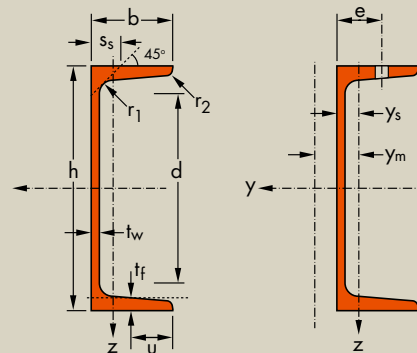

Denominación Designation Designazione	Dimensiones Dimensions Dimensioni							A mm ² x10 ²	Dimensiones de construcción Dimensions for detailing Dimensioni di dettaglio				Superficie Surface Superficie	
	G kg/m	h mm	b mm	t _w mm	t _f mm	r ₁ mm	r ₂ mm		d mm	∅	e _{min} mm	e _{max} mm	A _L m ² /m	A _C m ² /t
UPN 50*	5,59	50	38	5,0	7,0	7,0	3,5	7,12	21	-	-	-	0,232	42,22
UPN 65*	7,09	65	42	5,5	7,5	7,5	4,0	9,03	34	-	-	-	0,273	39,57
UPN 80*	8,64	80	45	6,0	8,0	8,0	4,0	11,0	47	-	-	-	0,312	37,10
UPN 100*	10,6	100	50	6,0	8,5	8,5	4,5	13,5	64	-	-	-	0,372	35,10
UPN 120	13,4	120	55	7,0	9,0	9,0	4,5	17,0	82	-	-	-	0,434	32,52
UPN 140	16,0	140	60	7,0	10,0	10,0	5,0	20,4	98	M 12	33	37	0,489	30,54
UPN 160	18,8	160	65	7,5	10,5	10,5	5,5	24,0	115	M 12	34	42	0,546	28,98
UPN 180	22,0	180	70	8,0	11,0	11,0	5,5	28,0	133	M 16	38	41	0,611	27,80
UPN 200	25,3	200	75	8,5	11,5	11,5	6,0	32,2	151	M 16	39	46	0,661	26,15
UPN 220	29,4	220	80	9,0	12,5	12,5	6,5	37,4	167	M 16	40	51	0,718	24,46
UPN 240	33,2	240	85	9,5	13,0	13,0	6,5	42,3	184	M 20	46	50	0,775	23,34
UPN 260	37,9	260	90	10,0	14,0	14,0	7,0	48,3	200	M 22	50	52	0,834	22,00
UPN 280	41,8	280	95	10,0	15,0	15,0	7,5	53,3	216	M 22	52	57	0,890	21,27
UPN 300	46,2	300	100	10,0	16,0	16,0	8,0	58,8	232	M 24	55	59	0,950	20,58
UPN 320*	59,5	320	100	14,0	17,5	17,5	8,8	75,8	246	M 22	58	62	0,982	16,50
UPN 350	60,6	350	100	14,0	16,0	16,0	8,0	77,3	282	M 22	56	62	1,05	17,25
UPN 380*	63,1	380	102	13,5	16,0	16,0	8,0	80,4	313	M 24	59	60	1,11	17,59
UPN 400*	71,8	400	110	14,0	18,0	18,0	9,0	91,5	324	M 27	61	62	1,18	16,46

	h ≤ 300	h > 300
u	$\frac{b}{2}$	$\frac{b - t_w}{2}$
Inclinación de las alas Flange slope Inclinazione ali	8%	5%

* Tonelaje mínimo y condiciones de suministro previo acuerdo.

* Minimum tonnage and delivery conditions upon agreement.

* Tonnellaggio minimo e condizioni di fornitura da concordare.

Páginas de notaciones 199-203 / Notations pages 199-203 / Pagine di annotazioni 199-203

Denominación Designation Designazione	Propiedades del perfil / Section properties / Proprietà geometriche del profilo															Classification EN 1993-1-1: 2005				EN 10025-2: 2004	EN 10025-4: 2004	EN 10225:2001	
	eje fuerte y-y strong axis y-y asse forte y-y						eje débil z-z weak axis z-z asse debole z-z					Pure bending y-y		Pure compression									
	G	I_y	$W_{el,y}$	$W_{pl,y}$ ■	i_y	A_{vz}	I_z	$W_{el,z}$	$W_{pl,z}$	i_z	s_s	I_t	I_w	y_s	y_m	S235	S355	S235	S355				
kg/m	mm ⁴ x10 ⁴	mm ³ x10 ³	mm ³ x10 ³	mm x10	mm ² x10 ²	mm ⁴ x10 ⁴	mm ³ x10 ³	mm ³ x10 ³	mm x10	mm	mm ⁴ x10 ⁴	mm ⁶ x10 ⁹	mm x10	mm x10									
UPN 50	5,59	26,4	10,6	13,1	1,92	2,77	9,12	3,75	6,78	1,13	16,7	1,12	0,03	1,37	2,47	1	1	1	1	✓			
UPN 65	7,09	57,5	17,7	21,7	2,52	3,68	14,1	5,07	9,38	1,25	18,0	1,61	0,08	1,42	2,60	1	1	1	1	✓			
UPN 80	8,64	106	26,5	32,3	3,10	4,90	19,4	6,36	11,9	1,33	19,4	2,20	0,18	1,45	2,67	1	1	1	1	✓			
UPN 100	10,6	206	41,2	49,0	3,91	6,46	29,3	8,49	16,2	1,47	20,3	2,81	0,41	1,55	2,93	1	1	1	1	✓			
UPN 120	13,4	364	60,7	72,6	4,62	8,80	43,2	11,1	21,2	1,59	22,2	4,15	0,90	1,60	3,03	1	1	1	1	✓			
UPN 140	16,0	605	86,4	103	5,45	10,4	62,7	14,8	28,3	1,75	23,9	5,68	1,80	1,75	3,37	1	1	1	1	✓			
UPN 160	18,8	925	116	138	6,21	12,6	85,3	18,3	35,2	1,89	25,3	7,39	3,26	1,84	3,56	1	1	1	1	✓			
UPN 180	22,0	1350	150	179	6,95	15,1	114	22,4	42,9	2,02	26,7	9,55	5,57	1,92	3,75	1	1	1	1	✓			
UPN 200	25,3	1910	191	228	7,70	17,7	148	27,0	51,8	2,14	28,1	11,9	9,07	2,01	3,94	1	1	1	1	✓			
UPN 220	29,4	2690	245	292	8,48	20,6	197	33,6	64,1	2,30	30,3	16,0	14,6	2,14	4,20	1	1	1	1	✓			
UPN 240	33,2	3600	300	358	9,22	23,7	248	39,6	75,7	2,42	31,7	19,7	22,1	2,23	4,39	1	1	1	1	✓			
UPN 260	37,9	4820	371	442	9,99	27,1	317	47,7	91,6	2,56	33,9	25,5	33,3	2,36	4,66	1	1	1	1	✓			
UPN 280	41,8	6280	448	532	10,9	29,3	399	57,2	109	2,74	35,6	31,0	48,5	2,53	5,02	1	1	1	1	✓			
UPN 300	46,2	8030	535	632	11,7	31,8	495	67,8	130	2,90	37,3	37,4	69,1	2,70	5,41	1	1	1	1	✓			
UPN 320	59,5	10870	679	826	12,1	47,1	597	80,6	152	2,81	43,0	66,7	96,1	2,60	4,82	1	1	1	1	✓			
UPN 350	60,6	12840	734	918	12,9	50,8	570	75,0	143	2,72	40,7	61,2	114	2,40	4,45	1	1	1	1	✓			
UPN 380	63,1	15760	829	1010	14,0	53,2	615	78,7	148	2,77	40,3	59,1	146	2,38	4,58	1	1	1	1	✓			
UPN 400	71,8	20350	1020	1240	14,9	58,6	846	102	190	3,04	44,0	81,6	221	2,65	5,11	1	1	1	1	✓			

- $W_{pl,y}$ se calcula según la hipótesis de un diagrama de tensiones birrectangular y sólo será aplicable cuando dos o más perfiles de sección en U estén combinados de tal manera que constituyan una sección doblemente simétrica, de tal modo que el momento de flexión que actúa en el plano del centro de gravedad no produzca torsión alguna.
- $W_{pl,y}$ is determined assuming a bi-rectangular stress block distribution. Thus, the given value applies only if two or more channels are combined in such a way to form a double symmetric cross-section so that the bending moment acting in the plane of the centre of gravity will not lead to torsion.
- $W_{pl,y}$ viene determinado presupponendo un diagramma delle sollecitazioni bi-rettangolare. Pertanto il valore dato vale unicamente se due o più sezioni a U vengono combinate in modo tale da formare una sezione doppiamente simmetrica cosicché il momento flettente che agisce nel piano del centro di gravità non produce torsione.

Perfiles U comerciales de alas inclinadas

Dimensiones: conforme a la norma de fábrica

Tolerancias: EN 10279: 2000

Estado de la superficie: conforme a norma EN 10163-3: 2004, clase C, subclase 1

Channels with taper flanges

Dimensions: in accordance with mill standard

Tolerances: EN 10279: 2000

Surface condition: according to EN 10163-3: 2004, class C, subclass 1

Profili U ad ali inclinate

Dimensioni: secondo lo standard dell'acciaieria.

Tolleranze: EN 10279: 2000

Condizioni di superficie: secondo EN 10163-3: 2004, classe C, sottoclasse 1

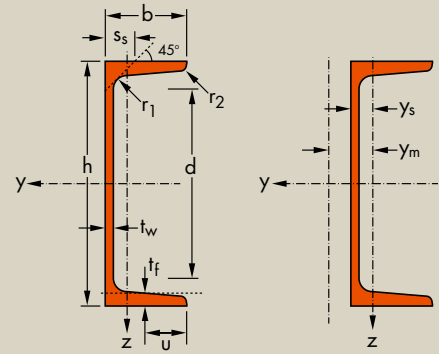

Denominación Designation Designazione	Dimensiones Dimensions Dimensioni								Superficie Surface Superficie		
	G kg/m	h mm	b mm	t _w mm	t _f mm	r ₁ mm	r ₂ mm	d mm	A mm ² x10 ²	A _L m ² /m	A _C m ² /t
U 40 x 20 x 4*	2,65	40	20	4,0	5,5	5,0	2,5	18,8	3,38	0,149	56,17
U 40 x 20*	2,87	40	20	5,0	5,5	5,0	2,5	19,0	3,66	0,142	51,20
U 50 x 25*	3,86	50	25	5,0	6,0	6,0	3,0	25,7	4,92	0,181	48,22
U 60 x 30*	5,07	60	30	6,0	6,0	6,0	3,0	35,5	6,46	0,215	44,06
U 65 x 42*	7,09	65	42	5,5	7,5	7,5	4,0	33,7	9,03	0,273	39,57

* Tonelaje mínimo y condiciones de suministro previo acuerdo.

* Minimum tonnage and delivery conditions upon agreement.

* Tonnellaggio minimo e condizioni di fornitura da concordare.



Páginas de notaciones 199-203 / Notations pages 199-203 / Pagine di annotazioni 199-203

Denominación Designation Designazione	Propiedades del perfil / Section properties / Proprietà geometriche del profilo															Classification EN 1993-1-1: 2005				EN 10025-2: 2004	EN 10025-4: 2004	EN 10225:2001	
	eje fuerte y-y strong axis y-y asse forte y-y						eje débil z-z weak axis z-z asse debole z-z					Pure bending y-y		Pure compression									
	G	I_y	$W_{el,y}$	$W_{pl,y}$ ■	i_y	A_z	I_z	$W_{el,z}$	$W_{pl,z}$	i_z	S_s	I_t	I_w	y_s	y_m	S235	S355	S235	S355				
kg/m	mm ⁴ x10 ⁴	mm ³ x10 ³	mm ³ x10 ³	mm x10	mm ² x10 ²	mm ⁴ x10 ⁴	mm ³ x10 ³	mm ³ x10 ³	mm x10	mm	mm ⁴ x10 ⁴	mm ⁶ x10 ⁹	mm x10	mm x10									
U 40 x 20 x 4	2,65	7,43	3,72	4,69	1,48	1,71	1,14	0,86	1,63	0,58	12,5	0,31	0,002	0,68	1,15	1	1	1	1	✓			
U 40 x 20	2,87	7,58	3,79	4,91	1,44	1,96	1,14	0,86	1,65	0,56	13,4	0,39	0,003	0,67	1,01	1	1	1	1	✓			
U 50 x 25	3,86	16,8	6,73	8,52	1,85	2,52	2,49	1,48	2,84	0,71	14,6	0,59	0,009	0,81	1,34	1	1	1	1	✓			
U 60 x 30	5,07	31,6	10,5	13,3	2,21	3,54	4,51	2,16	4,19	0,84	15,8	0,89	0,024	0,91	1,50	1	1	1	1	✓			
U 65 x 42	7,09	57,5	17,7	21,7	2,52	3,68	14,1	5,07	9,38	1,25	18,0	1,61	0,082	1,42	2,60	1	1	1	1	✓			

■ $W_{pl,y}$ se calcula según la hipótesis de un diagrama de tensiones birrectangular y sólo será aplicable cuando dos o más perfiles de sección en U estén combinados de tal manera que constituyan una sección doblemente simétrica, de tal modo que el momento de flexión que actúa en el plano del centro de gravedad no produzca torsión alguna.

■ $W_{pl,y}$ is determined assuming a bi-rectangular stress block distribution. Thus, the given value applies only if two or more channels are combined in such a way to form a double symmetric cross-section so that the bending moment acting in the plane of the centre of gravity will not lead to torsion.

■ $W_{pl,y}$ viene determinato presupponendo un diagramma delle sollecitazioni bi-rettangolare. Pertanto il valore dato vale unicamente se due o più sezioni a U vengono combinate in modo tale da formare una sezione doppiamente simmetrica cosicché il momento flettente che agisce nel piano del centro di gravità non produce torsione.

Perfiles U comerciales de alas inclinadas

Dimensiones: GOST 8240-97, PN-H-93451

Tolerancias: GOST 8240-97, EN 10279: 2000

Estado de la superficie: conforme a norma EN 10163-3: 2004, clase C, subclase 1

Channels with taper flanges

Dimensions: GOST 8240-97, PN-H-93451

Tolerances: GOST 8240-97, EN 10279: 2000

Surface condition: according to EN 10163-3: 2004, class C, subclass 1

Profili U ad ali inclinate

Dimensioni: GOST 8240-97, PN-H-93451

Tolleranze: GOST 8240-97, EN 10279: 2000

Condizioni di superficie: secondo EN 10163-3: 2004, classe C, sottoclasse 1

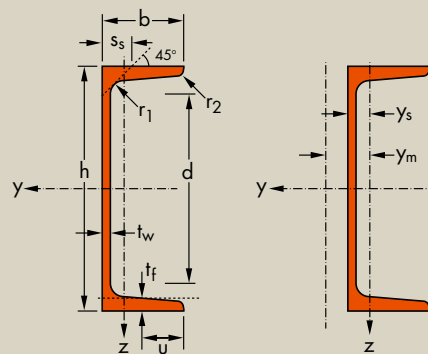

Denominación Designation Designazione	Dimensiones Dimensions Dimensioni								Superficie Surface Superficie		
	G kg/m	h mm	b mm	t _w mm	t _f mm	r ₁ mm	r ₂ mm	d mm	A mm ² x10 ²	A _L m ² /m	A _C m ² /t
UE 80*	7,05	80	40	4,5	7,4	6,5	2,5	50,7	8,98	0,304	43,70
UE 100*	8,59	100	46	4,5	7,6	7,0	3,0	68,9	10,90	0,367	43,29
UE 120*	10,40	120	52	4,8	7,8	7,5	3,0	87,2	13,30	0,429	41,71
UE 140*	12,30	140	58	4,9	8,1	8,0	3,0	105	15,60	0,492	40,55
UE 160*	14,20	160	64	5,0	8,4	8,5	3,5	123	18,10	0,555	39,51
UE 180*	16,30	180	70	5,1	8,7	9,0	3,5	141	20,70	0,617	38,46
UE 200*	18,40	200	76	5,2	9,0	9,5	4,0	159	23,40	0,681	37,51

* Tonelaje mínimo y condiciones de suministro previo acuerdo.

* Minimum tonnage and delivery conditions upon agreement.

* Tonnellaggio minimo e condizioni di fornitura da concordare.

Páginas de notaciones 199-203 / Notations pages 199-203 / Pagine di annotazioni 199-203

Denominación Designation Designazione	Propiedades del perfil / Section properties / Proprietà geometriche del profilo															Classification EN 1993-1-1: 2005				EN 10025-2: 2004	EN 10025-4: 2004	EN 10225:2001	
	eje fuerte y-y strong axis y-y asse forte y-y						eje débil z-z weak axis z-z asse debole z-z					Pure bending y-y		Pure compression									
	G	I_y	$W_{el,y}$	$W_{pl,y}$ ■	i_y	A_z	I_z	$W_{el,z}$	$W_{pl,z}$	i_z	S_s	I_t	I_w	y_s	y_m	S235	S355	S235	S355				
kg/m	mm ⁴ x10 ⁴	mm ³ x10 ³	mm ³ x10 ³	mm x10	mm ² x10 ²	mm ⁴ x10 ⁴	mm ³ x10 ³	mm ³ x10 ³	mm x10	mm	mm ⁴ x10 ⁴	mm ⁶ x10 ⁹	mm x10	mm x10									
UE 80	7,05	89,4	22,4	26,5	3,16	3,86	12,8	4,75	8,74	1,19	16,4	1,33	0,114	1,31	2,46	1	1	1	1	✓			
UE 100	8,59	174	34,8	40,7	3,99	4,83	20,4	6,46	12,0	1,37	17,1	1,69	0,296	1,44	2,76	1	1	1	1	✓			
UE 120	10,40	304	50,6	59,1	4,78	6,14	31,2	8,52	16,0	1,53	18,1	2,17	0,666	1,54	3,00	1	1	1	1	✓			
UE 140	12,30	491	70,2	81,4	5,60	7,32	45,4	11,0	20,7	1,70	19,0	2,74	1,34	1,67	3,28	1	1	1	1	✓			
UE 160	14,20	747	93,4	108	6,42	8,53	63,3	13,8	26,1	1,87	19,9	3,41	2,48	1,80	3,57	1	1	1	1	✓			
UE 180	16,30	1090	121	139	7,24	9,80	86,0	17,0	32,2	2,04	20,7	4,17	4,31	1,94	3,85	1	1	1	2	✓			
UE 200	18,40	1520	152	175	8,07	11,1	113	20,5	39,0	2,20	21,6	5,04	7,11	2,07	4,13	1	1	1	2	✓			

- $W_{pl,y}$ se calcula según la hipótesis de un diagrama de tensiones birrectangular y sólo será aplicable cuando dos o más perfiles de sección en U estén combinados de tal manera que constituyan una sección doblemente simétrica, de tal modo que el momento de flexión que actúa en el plano del centro de gravedad no produzca torsión alguna.
- $W_{pl,y}$ is determined assuming a bi-rectangular stress block distribution. Thus, the given value applies only if two or more channels are combined in such a way to form a double symmetric cross-section so that the bending moment acting in the plane of the centre of gravity will not lead to torsion.
- $W_{pl,y}$ viene determinado presupponendo un diagramma delle sollecitazioni bi-rettangolare. Pertanto il valore dato vale unicamente se due o più sezioni a U vengono combinate in modo tale da formare una sezione doppiamente simmetrica cosicché il momento flettente che agisce nel piano del centro di gravità non produce torsione

Perfiles angulares de lados iguales ▼

Dimensiones: EN 10056-1: 1998
Tolerancias: EN 10056-2: 1994
Estado de la superficie: conforme a norma EN 10163-3: 2004, clase C, subclase 1

Equal leg angles ▼

Dimensions: EN 10056-1: 1998
Tolerances: EN 10056-2: 1994
Surface condition: according to EN 10163-3: 2004, class C, subclass 1

Angolari a lati uguali ▼

Dimensioni: EN 10056-1: 1998
Tolleranze: EN 10056-2: 1994
Condizioni di superficie: secondo EN 10163-3: 2004, classe C, sottoclasse 1

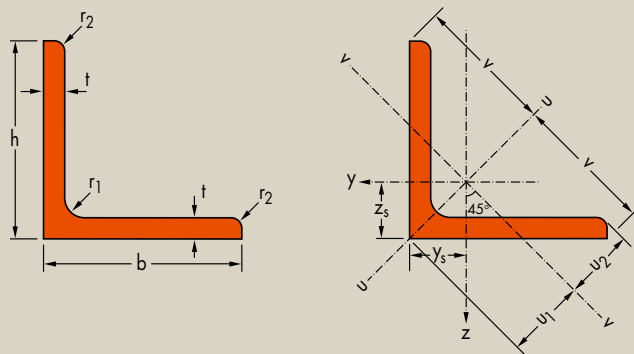

Denominación Designation Designazione	Dimensiones Dimensions Dimensioni					A mm ² x10 ²	Posición de los ejes Position of axes Posizione degli assi				Superficie Surface Superficie	
	G kg/m	h=b mm	t mm	r ₁ mm	r ₂ mm		z _s =y _s mm x10	v mm x10	u ₁ mm x10	u ₂ mm x10	A _L m ² /m	A _G m ² /t
L 20 x 20 x 3 ⁻	0,879	20	3	3,5	2,0	1,12	0,596	1,41	0,843	0,700	0,077	87,40
L 25 x 25 x 3 ^{-/▲}	1,11	25	3	3,5	2,0	1,42	0,721	1,77	1,02	0,877	0,097	86,88
L 25 x 25 x 4 ^{-/▲}	1,45	25	4	3,5	2,0	1,85	0,761	1,77	1,08	0,892	0,097	66,67
L 30 x 30 x 3 ^{-/▲}	1,36	30	3	5	2,5	1,74	0,835	2,12	1,18	1,05	0,116	84,87
L 30 x 30 x 4 ^{-/▲}	1,78	30	4	5	2,5	2,27	0,878	2,12	1,24	1,06	0,116	65,02
L 35 x 35 x 4 ^{-/▲}	2,09	35	4	5	2,5	2,67	1,00	2,47	1,42	1,24	0,136	64,82
L 40 x 40 x 4 ^{-/▲}	2,42	40	4	6	3,0	3,08	1,12	2,83	1,58	1,40	0,155	64,07
L 40 x 40 x 5 ^{-/▲}	2,97	40	5	6	3,0	3,79	1,16	2,83	1,64	1,41	0,155	52,07
L 45 x 45 x 4 ^{*/▲}	2,74	45	4	7	3,5	3,49	1,23	3,18	1,75	1,57	0,174	63,46
L 45 x 45 x 4,5 ^{*//▲}	3,06	45	4,5	7	3,5	3,90	1,26	3,18	1,78	1,58	0,174	56,83
L 45 x 45 x 5 ^{*/▲}	3,38	45	5	7	3,5	4,30	1,28	3,18	1,81	1,58	0,174	51,51
L 50 x 50 x 4 ^{-/▲}	3,06	50	4	7	3,5	3,89	1,36	3,54	1,92	1,75	0,194	63,49
L 50 x 50 x 5 ^{-/▲}	3,77	50	5	7	3,5	4,80	1,40	3,54	1,99	1,76	0,194	51,46
L 50 x 50 x 6 ^{-/▲}	4,47	50	6	7	3,5	5,69	1,45	3,54	2,04	1,77	0,194	43,41
L 50 x 50 x 7 ^{*/▲}	5,15	50	7	7	3,5	6,56	1,49	3,54	2,10	1,78	0,194	37,66
L 55 x 55 x 5 ^{*/▶}	4,18	55	5	8	4,0	5,32	1,52	3,89	2,15	1,93	0,213	51,05
L 55 x 55 x 6 ^{*/▲}	4,95	55	6	8	4,0	6,31	1,56	3,89	2,21	1,94	0,213	43,04
L 60 x 60 x 4 [*]	3,70	60	4	8	4,0	4,71	1,60	4,24	2,26	2,10	0,233	63,07
L 60 x 60 x 5 ^{-/▲}	4,57	60	5	8	4,0	5,82	1,64	4,24	2,32	2,11	0,233	51,04
L 60 x 60 x 6 ^{-/▲}	5,42	60	6	8	4,0	6,91	1,69	4,24	2,39	2,11	0,233	42,99
L 60 x 60 x 8 ^{-/▲}	7,09	60	8	8	4,0	9,03	1,77	4,24	2,50	2,14	0,233	32,89
L 65 x 65 x 6 ^{*/▶}	5,91	65	6	9	4,5	7,53	1,80	4,60	2,55	2,28	0,252	42,70
L 65 x 65 x 7 ⁻	6,83	65	7	9	4,5	8,70	1,85	4,60	2,61	2,29	0,252	36,95
L 65 x 65 x 8 ^{*/▶}	7,73	65	8	9	4,5	9,85	1,89	4,60	2,67	2,31	0,252	32,64

▼ Otras dimensiones previa solicitud. Según el proceso de laminación el radio r₂ puede tener dimensiones inferiores.

* Tonelaje mínimo y condiciones de suministro previo acuerdo.

+ Pedido mínimo: 40 t por perfil y calidad o según acuerdo.

- Perfil conforme a EN 10056-1: 1998.

▲ Perfil conforme a DIN 1028: 1994.

▶ Perfil conforme a CSN 42 5541: 1974.

▲ Disponible con aristas vivas.

▼ Other dimensions on request. The r₂ radius may be smaller depending on the rolling process.

* Minimum tonnage and delivery conditions upon agreement.

+ Minimum order: 40t per section and grade or upon agreement.

- Section in accordance with EN 10056-1: 1998.

▲ Section in accordance with DIN 1028: 1994.

▶ Section in accordance with CSN 42 5541: 1974.

▲ Available with sharp edges.

▼ Dimensioni di dettaglio disponibili su richiesta. Il raggio r₂ può essere minore a seconda del processo di laminazione.

* Tonnellaggio minimo e condizioni di fornitura da concordare.

+ Ordine minimo: 40t per sezione e qualità o da concordare.

- Sezione conforme a EN 10056-1: 1998.

▲ Sezione conforme a DIN 1028: 1994.

▶ Sezione conforme a CSN 42 5541: 1974.

▲ Disponibile con spigoli vivi.



Páginas de notaciones 199-203 / Notations pages 199-203 / Pagine di annotazioni 199-203

Denominación Designation Designazione	Propiedades del perfil / Section properties / Proprietà geometriche del profilo								Classification EN 1993-1-1: 2005		EN 10025-2: 2004	EN 10025-4: 2004	EN 10225:2001	
	eje y-y / eje z-z axis y-y / axis z-z asse y-y / asse z-z			eje u-u axis u-u asse u-u		eje v-v axis v-v asse v-v		Pure compression						
	$I_y = I_z$	$W_{ely} = W_{elz}$	$i_y = i_z$	I_u	i_u	I_v	i_v	I_{yz}	S235	S355				
G kg/m	mm ⁴ x10 ⁴	mm ³ x10 ³	mm x10	mm ⁴ x10 ⁴	mm x10	mm ⁴ x10 ⁴	mm x10	mm ⁴ x10 ⁴						
L 20 x 20 x 3	0,879	0,388	0,276	0,589	0,614	0,740	0,162	0,380	-0,226	1	1	✓		
L 25 x 25 x 3	1,11	0,796	0,448	0,749	1,26	0,944	0,329	0,481	-0,467	1	1	✓		
L 25 x 25 x 4	1,45	1,01	0,582	0,740	1,60	0,930	0,425	0,479	-0,587	1	1	✓		
L 30 x 30 x 3	1,36	1,40	0,649	0,899	2,23	1,13	0,579	0,578	-0,825	1	2	✓		
L 30 x 30 x 4	1,78	1,80	0,850	0,892	2,86	1,12	0,749	0,575	-1,05	1	1	✓		
L 35 x 35 x 4	2,09	2,95	1,18	1,05	4,69	1,33	1,22	0,68	-1,73	1	1	✓		
L 40 x 40 x 4	2,42	4,47	1,55	1,21	7,10	1,52	1,84	0,77	-2,63	1	2	✓		
L 40 x 40 x 5	2,97	5,43	1,91	1,20	8,61	1,51	2,25	0,77	-3,18	1	1	✓		
L 45 x 45 x 4	2,74	6,43	1,97	1,36	10,21	1,71	2,65	0,87	-3,78	1	3	✓		
L 45 x 45 x 4,5	3,06	7,15	2,20	1,35	11,35	1,71	2,95	0,87	-4,20	1	2	✓		
L 45 x 45 x 5	3,38	7,84	2,43	1,35	12,45	1,70	3,24	0,87	-4,60	1	1	✓		
L 50 x 50 x 4	3,06	8,97	2,46	1,52	14,25	1,91	3,70	0,97	-5,28	2	3	✓		
L 50 x 50 x 5	3,77	10,96	3,05	1,51	17,41	1,90	4,52	0,97	-6,45	1	2	✓		
L 50 x 50 x 6	4,47	12,84	3,61	1,50	20,37	1,89	5,31	0,97	-7,53	1	1	✓		
L 50 x 50 x 7	5,15	14,61	4,16	1,49	23,14	1,88	6,09	0,96	-8,52	1	1	✓		
L 55 x 55 x 5	4,18	14,71	3,70	1,66	23,37	2,10	6,06	1,07	-8,66	1	3	✓		
L 55 x 55 x 6	4,95	17,29	4,39	1,66	27,44	2,09	7,13	1,06	-10,16	1	1	✓		
L 60 x 60 x 4	3,70	15,78	3,58	1,83	25,04	2,31	6,51	1,18	-9,26	3	3	✓		
L 60 x 60 x 5	4,57	19,37	4,45	1,82	30,77	2,30	7,97	1,17	-11,40	2	3	✓		
L 60 x 60 x 6	5,42	22,79	5,29	1,82	36,20	2,29	9,38	1,17	-13,41	1	2	✓		
L 60 x 60 x 8	7,09	29,15	6,89	1,80	46,19	2,26	12,11	1,16	-17,04	1	1	✓		
L 65 x 65 x 6	5,91	29,19	6,21	1,97	46,36	2,48	12,01	1,26	-17,17	1	3	✓		
L 65 x 65 x 7	6,83	33,43	7,18	1,96	53,08	2,47	13,78	1,26	-19,65	1	1	✓		
L 65 x 65 x 8	7,73	37,49	8,13	1,95	59,46	2,46	15,52	1,26	-21,97	1	1	✓		

Perfiles angulares de lados iguales[▼] (continúa)

Dimensiones: EN 10056-1: 1998
Tolerancias: EN 10056-2: 1994
Estado de la superficie: conforme a norma EN 10163-3: 2004, clase C, subclase 1

Equal leg angles[▼] (continued)

Dimensions: EN 10056-1: 1998
Tolerances: EN 10056-2: 1994
Surface condition: according to EN 10163-3: 2004, class C, subclass 1

Angolari a lati uguali[▼] (continua)

Dimensioni: EN 10056-1: 1998
Tolleranze: EN 10056-2: 1994
Condizioni di superficie: secondo EN 10163-3: 2004, classe C, sottoclasse 1

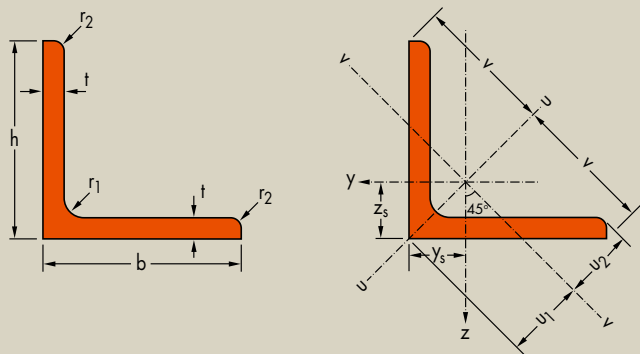

Denominación Designation Designazione	G kg/m	Dimensiones Dimensions Dimensioni				A mm ² x10 ²	Posición de los ejes Position of axes Posizione degli assi				Superficie Surface Superficie	
		h=b mm	t mm	r ₁ mm	r ₂ mm		z _s =y _s mm x10	v mm x10	u ₁ mm x10	u ₂ mm x10	A _L m ² /m	A _G m ² /t
L 70 x 70 x 6 ⁻	6,38	70	6	9	4,5	8,13	1,93	4,95	2,73	2,46	0,272	42,68
L 70 x 70 x 7 ⁻	7,38	70	7	9	4,5	9,40	1,97	4,95	2,79	2,47	0,272	36,91
L 70 x 70 x 8 ^{*/+}	8,37	70	8	10	5,0	10,7	2,01	4,95	2,84	2,47	0,271	32,41
L 70 x 70 x 9 ^{*/+}	9,32	70	9	9	4,5	11,9	2,05	4,95	2,90	2,50	0,272	29,20
L 75 x 75 x 4 [*]	4,65	75	4	9	4,5	5,93	1,96	5,30	2,76	2,63	0,292	62,82
L 75 x 75 x 5 [*]	5,76	75	5	9	4,5	7,34	2,01	5,30	2,84	2,63	0,292	50,75
L 75 x 75 x 6 ⁻	6,85	75	6	9	4,5	8,73	2,05	5,30	2,90	2,64	0,292	42,66
L 75 x 75 x 7 [*]	7,93	75	7	9	4,5	10,1	2,10	5,30	2,96	2,65	0,292	36,88
L 75 x 75 x 8 ⁻	8,99	75	8	9	4,5	11,4	2,14	5,30	3,02	2,66	0,292	32,53
L 75 x 75 x 10 [*]	11,1	75	10	9	4,5	14,1	2,22	5,30	3,13	2,69	0,292	26,43
L 80 x 80 x 5 [*]	6,17	80	5	10	5,0	7,86	2,12	5,66	3,00	2,81	0,311	50,49
L 80 x 80 x 6 ^{*/+}	7,34	80	6	10	5,0	9,35	2,17	5,66	3,07	2,81	0,311	42,44
L 80 x 80 x 7 [*]	8,49	80	7	10	5,0	10,8	2,21	5,66	3,13	2,82	0,311	36,67
L 80 x 80 x 8 ⁻	9,63	80	8	10	5,0	12,3	2,26	5,66	3,19	2,83	0,311	32,34
L 80 x 80 x 10 ⁻	11,9	80	10	10	5,0	15,1	2,34	5,66	3,30	2,85	0,311	26,26
L 90 x 90 x 6 ^{*/+}	8,28	90	6	10	5,0	10,5	2,42	6,36	3,42	3,16	0,351	42,44
L 90 x 90 x 7 ⁻	9,61	90	7	11	5,5	12,2	2,45	6,36	3,47	3,16	0,351	36,48
L 90 x 90 x 8 ⁻	10,9	90	8	11	5,5	13,9	2,50	6,36	3,53	3,17	0,351	32,15
L 90 x 90 x 9 ⁻	12,2	90	9	11	5,5	15,5	2,54	6,36	3,59	3,18	0,351	28,77
L 90 x 90 x 10 ⁻	13,4	90	10	11	5,5	17,1	2,58	6,36	3,65	3,19	0,351	26,07
L 90 x 90 x 11 [*]	14,7	90	11	11	5,5	18,7	2,62	6,36	3,70	3,21	0,351	23,86
L 100 x 100 x 6 ^{*/+}	9,26	100	6	12	6,0	11,8	2,64	7,07	3,74	3,51	0,390	42,09
L 100 x 100 x 7 [*]	10,7	100	7	12	6,0	13,7	2,69	7,07	3,81	3,51	0,390	36,33
L 100 x 100 x 8 ^{*/+}	12,2	100	8	12	6,0	15,5	2,74	7,07	3,87	3,52	0,390	32,00
L 100 x 100 x 10 ^{*/+}	15,0	100	10	12	6,0	19,2	2,82	7,07	3,99	3,54	0,390	25,92
L 100 x 100 x 12 ^{*/+}	17,8	100	12	12	6,0	22,7	2,90	7,07	4,11	3,57	0,390	21,86
L 110 x 110 x 8 ^{*/+}	13,4	110	8	12	6,0	17,1	2,99	7,78	4,22	3,87	0,430	31,98
L 110 x 110 x 10 ^{*/+}	16,6	110	10	13	6,5	21,2	3,06	7,78	4,33	3,88	0,429	25,79
L 110 x 110 x 12 [*]	19,7	110	12	13	6,5	25,1	3,15	7,78	4,45	3,91	0,429	21,73

▼ Otras dimensiones previa solicitud. Según el proceso de laminación el radio r₂ puede tener dimensiones inferiores.
* Tonelaje mínimo y condiciones de suministro previo acuerdo.
+ Pedido mínimo: 40 t por perfil y calidad o según acuerdo.
- Perfil conforme a EN 10056-1: 1998.
◄ Perfil conforme a DIN 1028: 1994.
► Perfil conforme a CSN 42 5541: 1974.
▲ Disponible con aristas vivas.

▼ Other dimensions on request. The r₂ radius may be smaller depending on the rolling process.
* Minimum tonnage and delivery conditions upon agreement.
+ Minimum order: 40t per section and grade or upon agreement.
- Section in accordance with EN 10056-1: 1998.
◄ Section in accordance with DIN 1028: 1994.
► Section in accordance with CSN 42 5541: 1974.
▲ Available with sharp edges.

▼ Dimensioni di dettaglio disponibili su richiesta. Il raggio r₂ può essere minore a seconda del processo di laminazione.
* Tonnellaggio minimo e condizioni di fornitura da concordare.
+ Ordine minimo: 40t per sezione e qualità o da concordare.
- Sezione conforme a EN 10056-1: 1998.
◄ Sezione conforme a DIN 1028: 1994.
► Sezione conforme a CSN 42 5541: 1974.
▲ Disponibile con spigoli vivi.



Páginas de notaciones 199-203 / Notations pages 199-203 / Pagine di annotazioni 199-203

Denominación Designation Designazione	Propiedades del perfil / Section properties / Proprietà geometriche del profilo									Classification EN 1993-1-1: 2005		EN 10025-2: 2004	EN 10025-4: 2004	EN 10225:2001
	eje y-y / eje z-z axis y-y / axis z-z asse y-y / asse z-z			eje u-u axis u-u asse u-u		eje v-v axis v-v asse v-v		Pure compression						
	G	$I_y = I_z$	$W_{ely} = W_{elz}$	$i_y = i_z$	I_u	i_u	I_v	i_v	I_{yz}	S235	S355			
kg/m	mm ⁴ x10 ⁴	mm ³ x10 ³	mm x10	mm ⁴ x10 ⁴	mm x10	mm ⁴ x10 ⁴	mm x10	mm ⁴ x10 ⁴						
L 70 x 70 x 6	6,38	36,88	7,27	2,13	58,60	2,69	15,16	1,37	-21,72	2	3	✓		
L 70 x 70 x 7	7,38	42,30	8,41	2,12	67,19	2,67	17,41	1,36	-24,89	1	2	✓		
L 70 x 70 x 8	8,37	47,27	9,46	2,10	75,01	2,65	19,52	1,35	-27,75	1	1	✓		
L 70 x 70 x 9	9,32	52,47	10,60	2,10	83,18	2,65	21,76	1,35	-30,71	1	1	✓		
L 75x75x4	4,65	31,43	5,67	2,30	49,85	2,90	13,01	1,48	-18,42	4	4	✓		
L 75x75x5	5,76	38,77	7,06	2,30	61,59	2,90	15,96	1,47	-22,82	3	3	✓		
L 75 x 75 x 6	6,85	45,83	8,41	2,29	72,84	2,89	18,82	1,47	-27,01	2	3	✓		
L 75x75x7	7,93	52,61	9,74	2,28	83,60	2,88	21,62	1,46	-30,99	1	3	✓		
L 75 x 75 x 8	8,99	59,13	11,03	2,27	93,91	2,86	24,35	1,46	-34,78	1	1	✓		
L 75x75x10	11,1	71,43	13,52	2,25	113,2	2,83	29,68	1,45	-41,75	1	1	✓		
L 80 x 80 x 5	6,17	47,14	8,02	2,45	74,83	3,09	19,45	1,57	-27,69	3	4	✓		
L 80 x 80 x 6	7,34	55,82	9,57	2,44	88,69	3,08	22,96	1,57	-32,87	3	3	✓		
L 80 x 80 x 7	8,49	64,19	11,09	2,44	102,0	3,07	26,38	1,56	-37,81	1	3	✓		
L 80 x 80 x 8	9,63	72,25	12,58	2,43	114,8	3,06	29,72	1,56	-42,52	1	2	✓		
L 80 x 80 x 10	11,9	87,50	15,45	2,41	138,8	3,03	36,24	1,55	-51,27	1	1	✓		
L 90 x 90 x 6	8,28	80,72	12,26	2,77	128,3	3,49	33,16	1,77	-47,57	3	4	✓		
L 90 x 90 x 7	9,61	92,55	14,13	2,75	147,1	3,47	38,03	1,76	-54,52	3	3	✓		
L 90 x 90 x 8	10,9	104,4	16,05	2,74	165,9	3,46	42,89	1,76	-61,50	1	3	✓		
L 90 x 90 x 9	12,2	115,8	17,93	2,73	184,0	3,44	47,65	1,75	-68,19	1	2	✓		
L 90 x 90 x 10	13,4	126,9	19,77	2,72	201,5	3,43	52,33	1,75	-74,59	1	1	✓		
L 90 x 90 x 11	14,7	137,6	21,57	2,71	218,3	3,42	56,94	1,74	-80,70	1	1	✓		
L 100 x 100 x 6	9,26	111,1	15,09	3,07	176,3	3,87	45,80	1,97	-65,25	3	4	✓		
L 100 x 100 x 7	10,7	128,2	17,54	3,06	203,7	3,86	52,72	1,96	-75,48	3	3	✓		
L 100 x 100 x 8	12,2	144,8	19,94	3,06	230,2	3,85	59,49	1,96	-85,35	2	3	✓		
L 100 x 100 x 10	15,0	176,7	24,62	3,04	280,7	3,83	72,66	1,95	-104,0	1	2	✓		
L 100 x 100 x 12	17,8	206,7	29,12	3,02	327,9	3,80	85,44	1,94	-121,3	1	1	✓		
L 110 x 110 x 8	13,4	195,3	24,37	3,38	310,5	4,26	80,11	2,16	-115,2	3	3	✓		
L 110 x 110 x 10	16,6	238,0	29,99	3,35	378,2	4,23	97,74	2,15	-140,2	1	3	✓		
L 110 x 110 x 12	19,7	279,1	35,54	3,33	443,2	4,20	115,0	2,14	-164,1	1	1	✓		

Perfiles angulares de lados iguales[▼] (continúa)

Dimensiones: EN 10056-1: 1998
Tolerancias: EN 10056-2: 1994
Estado de la superficie: conforme a norma EN 10163-3: 2004, clase C, subclase 1

Equal leg angles[▼] (continued)

Dimensions: EN 10056-1: 1998
Tolerances: EN 10056-2: 1994
Surface condition: according to EN 10163-3: 2004, class C, subclass 1

Angolari a lati uguali[▼] (continua)

Dimensioni: EN 10056-1: 1998
Tolleranze: EN 10056-2: 1994
Condizioni di superficie: secondo EN 10163-3: 2004, classe C, sottoclasse 1

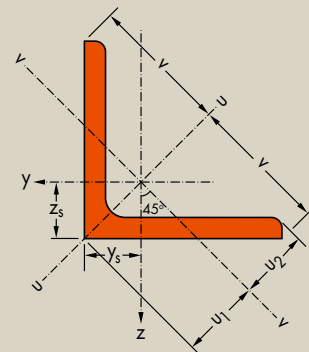
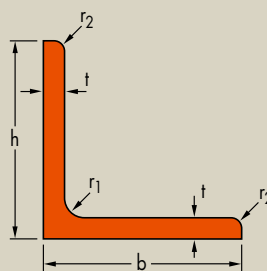

Denominación Designation Designazione	Dimensiones Dimensions Dimensioni					A mm ² x10 ²	Posición de los ejes Position of axes Posizione degli assi				Superficie Surface Superficie	
	G kg/m	h=b mm	t mm	r ₁ mm	r ₂ mm		z _s =y _s mm x10	v mm x10	u ₁ mm x10	u ₂ mm x10	A _L m ² /m	A _G m ² /t
L 120 x 120 x 8 ^{*/+/-/x}	14,7	120	8	13	6,5	18,7	3,23	8,49	4,56	4,22	0,469	31,87
L 120 x 120 x 10 ^{-/x}	18,2	120	10	13	6,5	23,2	3,31	8,49	4,69	4,24	0,469	25,76
L 120 x 120 x 11 ^{+/x}	19,9	120	11	13	6,5	25,4	3,36	8,49	4,75	4,25	0,469	23,54
L 120 x 120 x 12 ^{-/x}	21,6	120	12	13	6,5	27,5	3,40	8,49	4,80	4,26	0,469	21,69
L 120 x 120 x 13 ^{*/x}	23,3	120	13	13	6,5	29,7	3,44	8,49	4,86	4,28	0,469	20,12
L 120 x 120 x 15 ^{*/x}	26,6	120	15	13	6,5	33,9	3,51	8,49	4,97	4,31	0,469	17,60
L 130 x 130 x 10 ^{*/x}	19,8	130	10	14	7,0	25,2	3,55	9,19	5,03	4,58	0,508	25,67
L 130 x 130 x 12 ^{*/-/x}	23,5	130	12	14	7,0	30,0	3,64	9,19	5,15	4,60	0,508	21,59
L 130 x 130 x 13 ^{*/x}	25,4	130	13	14	7,0	32,3	3,68	9,19	5,20	4,62	0,508	20,02
L 130 x 130 x 14 ^{*/+/-/x}	27,2	130	14	14	7,0	34,7	3,72	9,19	5,26	4,63	0,508	18,68
L 130 x 130 x 16 ^{*/x}	30,8	130	16	14	7,0	39,3	3,80	9,19	5,37	4,66	0,508	16,49
L 150 x 150 x 10 ^{+/-/x}	23,0	150	10	16	8,0	29,3	4,03	10,61	5,71	5,28	0,586	25,51
L 150 x 150 x 12 ^{+/-/x}	27,3	150	12	16	8,0	34,8	4,12	10,61	5,83	5,29	0,586	21,44
L 150 x 150 x 14 ^{+/-/x}	31,6	150	14	16	8,0	40,3	4,21	10,61	5,95	5,32	0,586	18,53
L 150 x 150 x 15 ^{+/-/x}	33,8	150	15	16	8,0	43,0	4,25	10,61	6,01	5,33	0,586	17,36
L 150 x 150 x 18 ^{+/x}	40,1	150	18	16	8,0	51,0	4,37	10,61	6,17	5,37	0,586	14,63
L 160 x 160 x 14 ^{+/x}	33,9	160	14	17	8,5	43,2	4,45	11,31	6,29	5,66	0,625	18,46
L 160 x 160 x 15 ^{+/-/x}	36,2	160	15	17	8,5	46,1	4,49	11,31	6,35	5,67	0,625	17,30
L 160 x 160 x 16 ^{+/x}	38,4	160	16	17	8,5	49,0	4,53	11,31	6,41	5,69	0,625	16,28
L 160 x 160 x 17 ^{+/-/x}	40,7	160	17	17	8,5	51,8	4,57	11,31	6,46	5,70	0,625	15,37
L 180 x 180 x 13 ^{+/x}	35,7	180	13	18	9,0	45,5	4,90	12,73	6,93	6,35	0,705	19,74
L 180 x 180 x 14 ^{+/x}	38,3	180	14	18	9,0	48,8	4,94	12,73	6,99	6,36	0,705	18,40
L 180 x 180 x 15 ^{+/x}	40,9	180	15	18	9,0	52,1	4,98	12,73	7,05	6,37	0,705	17,23
L 180 x 180 x 16 ^{+/-/x}	43,5	180	16	18	9,0	55,4	5,02	12,73	7,10	6,38	0,705	16,20
L 180 x 180 x 17 ^{+/x}	46,0	180	17	18	9,0	58,7	5,06	12,73	7,16	6,40	0,705	15,30
L 180 x 180 x 18 ^{+/-/x}	48,6	180	18	18	9,0	61,9	5,10	12,73	7,22	6,41	0,705	14,50
L 180 x 180 x 19 ^{+/x}	51,1	180	19	18	9,0	65,1	5,14	12,73	7,27	6,42	0,705	13,78
L 180 x 180 x 20 ^{+/x}	53,7	180	20	18	9,0	68,3	5,18	12,73	7,33	6,44	0,705	13,13

▼ Otras dimensiones previa solicitud. Según el proceso de laminación el radio r₂ puede tener dimensiones inferiores.
* Tonelaje mínimo y condiciones de suministro previo acuerdo.
+ Pedido mínimo: 40 t por perfil y calidad o según acuerdo.
- Perfil conforme a EN 10056-1: 1998.
◄ Perfil conforme a DIN 1028: 1994.
► Perfil conforme a CSN 42 5541: 1974.
▲ Disponible con aristas vivas.
x Perfil S460M disponible previa solicitud.

▼ Other dimensions on request. The r₂ radius may be smaller depending on the rolling process.
* Minimum tonnage and delivery conditions upon agreement.
+ Minimum order: 40t per section and grade or upon agreement.
- Section in accordance with EN 10056-1: 1998.
◄ Section in accordance with DIN 1028: 1994.
► Section in accordance with CSN 42 5541: 1974.
▲ Available with sharp edges.
x Section available in S460M upon agreement.

▼ Dimensioni di dettaglio disponibili su richiesta. Il raggio r₂ può essere minore a seconda del processo di laminazione.
* Tonnellaggio minimo e condizioni di fornitura da concordare.
+ Ordine minimo: 40t per sezione e qualità o da concordare.
- Sezione conforme a EN 10056-1: 1998.
◄ Sezione conforme a DIN 1028: 1994.
► Sezione conforme a CSN 42 5541: 1974.
▲ Disponibile con spigoli vivi.
x Sezione S460M disponibile su richiesta.



Páginas de notaciones 199-203 / Notations pages 199-203 / Pagine di annotazioni 199-203

Denominación Designation Designazione	Propiedades del perfil / Section properties / Proprietà geometriche del profilo								Classification EN 1993-1-1: 2005		EN 10025-2: 2004	EN 10025-4: 2004	EN 10225:2001	
	eje y-y / eje z-z axis y-y / axis z-z asse y-y / asse z-z			eje u-u axis u-u asse u-u		eje v-v axis v-v asse v-v		Pure compression						
	G	$I_y = I_z$	$W_{el,y} = W_{el,z}$	$i_y = i_z$	I_u	i_u	I_v	i_v	I_{yz}	S235				S355
kg/m	mm ⁴ x10 ⁴	mm ³ x10 ³	mm x10	mm ⁴ x10 ⁴	mm x10	mm ⁴ x10 ⁴	mm x10	mm ⁴ x10 ⁴						
L 120 x 120 x 8	14,7	255,4	29,11	3,69	406,0	4,65	104,8	2,37	-150,6	3	4	✓		
L 120 x 120 x 10	18,2	312,9	36,03	3,67	497,6	4,63	128,3	2,35	-184,6	2	3	✓		
L 120 x 120 x 11	19,9	340,6	39,41	3,66	541,5	4,62	139,8	2,35	-200,9	1	3	✓		
L 120 x 120 x 12	21,6	367,7	42,73	3,65	584,3	4,61	151,1	2,34	-216,6	1	2	✓		
L 120 x 120 x 13	23,3	394,0	46,01	3,64	625,8	4,59	162,2	2,34	-231,8	1	1	✓		
L 120 x 120 x 15	26,6	444,9	52,43	3,62	705,6	4,56	184,2	2,33	-260,7	1	1	✓		
L 130 x 130 x 10	19,8	401,1	42,47	3,99	637,8	5,03	164,5	2,55	-236,7	3	3	✓		
L 130 x 130 x 12	23,5	472,2	50,44	3,97	750,6	5,00	193,7	2,54	-278,4	1	3	✓		
L 130 x 130 x 13	25,4	506,5	54,35	3,96	804,9	4,99	208,1	2,54	-298,4	1	2	✓		
L 130 x 130 x 14	27,2	540,1	58,20	3,95	857,8	4,98	222,3	2,53	-317,8	1	1	✓		
L 130 x 130 x 16	30,8	605,0	65,75	3,93	959,7	4,94	250,3	2,53	-354,7	1	1	✓		
L 150 x 150 x 10	23,0	624,0	56,91	4,62	992,0	5,82	256,1	2,96	-368,0	3	4	✓		
L 150 x 150 x 12	27,3	736,9	67,75	4,60	1172	5,80	302,1	2,94	-434,9	3	3	✓		
L 150 x 150 x 14	31,6	845,4	78,33	4,58	1344	5,77	346,9	2,93	-498,5	1	3	✓		
L 150 x 150 x 15	33,8	898,1	83,52	4,57	1427	5,76	369,0	2,93	-529,1	1	2	✓		
L 150 x 150 x 18	40,1	1050	98,74	4,54	1666	5,71	433,8	2,92	-616,1	1	1	✓		
L 160 x 160 x 14	33,9	1034	89,50	4,89	1644	6,17	423,9	3,13	-609,9	2	3	✓		
L 160 x 160 x 15	36,2	1099	95,47	4,88	1747	6,16	450,9	3,13	-647,9	1	3	✓		
L 160 x 160 x 16	38,4	1163	101,4	4,87	1848	6,14	477,7	3,12	-685,0	1	2	✓		
L 160 x 160 x 17	40,7	1225	107,2	4,86	1947	6,13	504,2	3,12	-721,2	1	2	✓		
L 180 x 180 x 13	35,7	1396	106,5	5,54	2220	6,99	571,7	3,55	-824,4	3	3	✓		
L 180 x 180 x 14	38,3	1493	114,3	5,53	2375	6,98	611,4	3,54	-881,8	3	3	✓		
L 180 x 180 x 15	40,9	1589	122,0	5,52	2527	6,96	650,6	3,53	-938,0	2	3	✓		
L 180 x 180 x 16	43,5	1682	129,7	5,51	2675	6,95	689,4	3,53	-993,0	2	3	✓		
L 180 x 180 x 17	46,0	1775	137,2	5,50	2822	6,94	727,9	3,52	-1047	1	3	✓		
L 180 x 180 x 18	48,6	1866	144,7	5,49	2965	6,92	766,0	3,52	-1100	1	2	✓		
L 180 x 180 x 19	51,1	1955	152,1	5,48	3106	6,91	803,8	3,51	-1151	1	2	✓		
L 180 x 180 x 20	53,7	2043	159,4	5,47	3244	6,89	841,3	3,51	-1202	1	1	✓		

Perfiles angulares de lados iguales[▼] (continúa)

Dimensiones: EN 10056-1: 1998
Tolerancias: EN 10056-2: 1994
Estado de la superficie: conforme a norma EN 10163-3: 2004, clase C, subclase 1

Equal leg angles[▼] (continued)

Dimensions: EN 10056-1: 1998
Tolerances: EN 10056-2: 1994
Surface condition: according to EN 10163-3: 2004, class C, subclass 1

Angolari a lati uguali[▼] (continua)

Dimensioni: EN 10056-1: 1998
Tolleranze: EN 10056-2: 1994
Condizioni di superficie: secondo EN 10163-3: 2004, classe C, sottoclasse 1

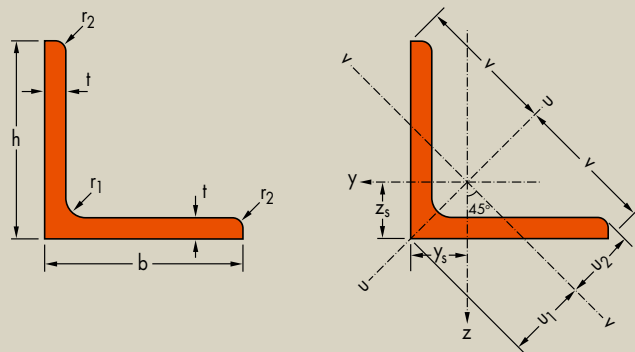

Denominación Designation Designazione	Dimensiones Dimensions Dimensioni					A mm ² x10 ²	Posición de los ejes Position of axes Posizione degli assi				Superficie Surface Superficie	
	G kg/m	h=b mm	t mm	r ₁ mm	r ₂ mm		z _s =y _s mm x10	v mm x10	u ₁ mm x10	u ₂ mm x10	A _L m ² /m	A _G m ² /t
L 200 x 200 x 15 ^{+/-x}	45,6	200	15	18	9,0	58,1	5,48	14,14	7,75	7,08	0,785	17,20
L 200 x 200 x 16 ^{+/-x}	48,5	200	16	18	9,0	61,8	5,52	14,14	7,81	7,09	0,785	16,18
L 200 x 200 x 17 ^{+/-x}	51,4	200	17	18	9,0	65,5	5,56	14,14	7,87	7,10	0,785	15,27
L 200 x 200 x 18 ^{+/-x}	54,2	200	18	18	9,0	69,1	5,60	14,14	7,93	7,12	0,785	14,46
L 200 x 200 x 19 ^{+/-x}	57,1	200	19	18	9,0	72,7	5,64	14,14	7,98	7,13	0,785	13,74
L 200 x 200 x 20 ^{+/-x}	59,9	200	20	18	9,0	76,3	5,68	14,14	8,04	7,15	0,785	13,09
L 200 x 200 x 21 ^{+/-x}	62,8	200	21	18	9,0	79,9	5,72	14,14	8,09	7,16	0,785	12,50
L 200 x 200 x 22 ^{+/-x}	65,6	200	22	18	9,0	83,5	5,76	14,14	8,15	7,18	0,785	11,97
L 200 x 200 x 23 ^{+/-x}	68,3	200	23	18	9,0	87,1	5,80	14,14	8,20	7,19	0,785	11,48
L 200 x 200 x 24 ^{+/-x}	71,1	200	24	18	9,0	90,6	5,84	14,14	8,26	7,21	0,785	11,03
L 200 x 200 x 25 ^{+/-x}	73,9	200	25	18	9,0	94,1	5,88	14,14	8,31	7,23	0,785	10,62
L 200 x 200 x 26 ^{+/-x}	76,6	200	26	18	9,0	97,6	5,91	14,14	8,36	7,25	0,785	10,24
L 250 x 250 x 20 ⁺	75,6	250	20	18	9,0	96,3	6,93	17,68	9,81	8,91	0,985	13,02
L 250 x 250 x 21 ⁺	79,2	250	21	18	9,0	101	6,97	17,68	9,86	8,93	0,985	12,43
L 250 x 250 x 22 ⁺	82,8	250	22	18	9,0	106	7,01	17,68	9,92	8,94	0,985	11,89
L 250 x 250 x 23 ⁺	86,4	250	23	18	9,0	110	7,05	17,68	9,97	8,96	0,985	11,40
L 250 x 250 x 24 ⁺	90,0	250	24	18	9,0	115	7,09	17,68	10,03	8,98	0,985	10,95
L 250 x 250 x 25 ⁺	93,5	250	25	18	9,0	119	7,13	17,68	10,08	8,99	0,985	10,53
L 250 x 250 x 26 ⁺	97,0	250	26	18	9,0	124	7,17	17,68	10,13	9,01	0,985	10,15
L 250 x 250 x 27 ⁺	101	250	27	18	9,0	128	7,20	17,68	10,19	9,03	0,985	9,79
L 250 x 250 x 28 ^{+/-}	104	250	28	18	9,0	133	7,24	17,68	10,24	9,04	0,985	9,47
L 250 x 250 x 35 ^{+/-}	128	250	35	18	9,0	163	7,50	17,68	10,61	9,17	0,985	7,69

▼ Otras dimensiones previa solicitud. Según el proceso de laminación el radio r₂ puede tener dimensiones inferiores.
* Tonelaje mínimo y condiciones de suministro previo acuerdo.
+ Pedido mínimo: 40 t por perfil y calidad o según acuerdo.
- Perfil conforme a EN 10056-1: 1998.
◄ Perfil conforme a DIN 1028: 1994.
► Perfil conforme a CSN 42 5541: 1974.
▲ Disponible con aristas vivas.
x Perfil S460M disponible previa solicitud

▼ Other dimensions on request. The r₂ radius may be smaller depending on the rolling process.
* Minimum tonnage and delivery conditions upon agreement.
+ Minimum order: 40t per section and grade or upon agreement.
- Section in accordance with EN 10056-1: 1998.
◄ Section in accordance with DIN 1028: 1994.
► Section in accordance with CSN 42 5541: 1974.
▲ Available with sharp edges.
x Section available in S460M upon agreement.

▼ Dimensioni di dettaglio disponibili su richiesta. Il raggio r₂ può essere minore a seconda del processo di laminazione.
* Tonnellaggio minimo e condizioni di fornitura da concordare.
+ Ordine minimo: 40t per sezione e qualità o da concordare.
- Sezione conforme a EN 10056-1: 1998.
◄ Sezione conforme a DIN 1028: 1994.
► Sezione conforme a CSN 42 5541: 1974.
▲ Disponibile con spigoli vivi.
x Sezione S460M disponibile su richiesta.



Páginas de notaciones 199-203 / Notations pages 199-203 / Pagine di annotazioni 199-203

Denominación Designation Designazione	Propiedades del perfil / Section properties / Proprietà geometriche del profilo								Classification EN 1993-1-1: 2005		EN 10025-2: 2004	EN 10025-4: 2004	EN 10225:2001	
	eje y-y / eje z-z axis y-y / axis z-z asse y-y / asse z-z			eje u-u axis u-u asse u-u		eje v-v axis v-v asse v-v		Pure compression						
	$I_y = I_z$	$W_{ely} = W_{elz}$	$i_y = i_z$	I_u	i_u	I_v	i_v	I_{yz}	S235	S355				
G kg/m	mm ⁴ x10 ⁴	mm ³ x10 ³	mm x10	mm ⁴ x10 ⁴	mm x10	mm ⁴ x10 ⁴	mm x10	mm ⁴ x10 ⁴						
L 200 x 200 x 15	45,6	2209	152,2	6,17	3516	7,78	903,0	3,94	-1306	3	3	✓		
L 200 x 200 x 16	48,5	2341	161,7	6,16	3725	7,76	957,2	3,94	-1384	3	3	✓		
L 200 x 200 x 17	51,4	2472	171,2	6,14	3932	7,75	1011	3,93	-1461	2	3	✓		
L 200 x 200 x 18	54,2	2600	180,6	6,13	4135	7,74	1064	3,92	-1535	2	3	✓		
L 200 x 200 x 19	57,1	2726	189,9	6,12	4335	7,72	1117	3,92	-1609	1	3	✓		
L 200 x 200 x 20	59,9	2851	199,1	6,11	4532	7,70	1169	3,91	-1681	1	2	✓		
L 200 x 200 x 21	62,8	2973	208,2	6,10	4725	7,69	1221	3,91	-1752	1	2	✓		
L 200 x 200 x 22	65,6	3094	217,3	6,09	4915	7,67	1273	3,90	-1821	1	1	✓		
L 200 x 200 x 23	68,3	3213	226,3	6,08	5102	7,66	1324	3,90	-1889	1	1	✓		
L 200 x 200 x 24	71,1	3331	235,2	6,06	5286	7,64	1375	3,90	-1955	1	1	✓		
L 200 x 200 x 25	73,9	3446	244,0	6,05	5467	7,62	1426	3,89	-2020	1	1	✓		
L 200 x 200 x 26	76,6	3560	252,7	6,04	5644	7,61	1476	3,89	-2084	1	1	✓		
L 250 x 250 x 20	75,6	5743	317,9	7,72	9144	9,74	2341	4,93	-3401	3	3	✓		
L 250 x 250 x 21	79,2	5997	332,7	7,71	9548	9,73	2447	4,92	-3550	3	3	✓		
L 250 x 250 x 22	82,8	6249	347,4	7,70	9946	9,71	2552	4,92	-3697	2	3	✓		
L 250 x 250 x 23	86,4	6497	362,0	7,68	10339	9,69	2655	4,91	-3842	2	3	✓		
L 250 x 250 x 24	90,0	6743	376,5	7,67	10727	9,68	2759	4,91	-3984	1	3	✓		
L 250 x 250 x 25	93,5	6986	390,9	7,66	11110	9,66	2861	4,90	-4124	1	3	✓		
L 250 x 250 x 26	97,0	7226	405,2	7,65	11488	9,64	2963	4,90	-4262	1	2	✓		
L 250 x 250 x 27	101	7463	419,3	7,63	11861	9,62	3065	4,89	-4398	1	2	✓		
L 250 x 250 x 28	104	7697	433,4	7,62	12229	9,61	3166	4,89	-4532	1	1	✓		
L 250 x 250 x 35	128	9264	529,4	7,54	14668	9,48	3859	4,86	-5405	1	1	✓		

Perfiles angulares de lados iguales[▼] (continúa)

Dimensiones: EN 10056-1: 1998
Tolerancias: EN 10056-2: 1994
Estado de la superficie: conforme a norma EN 10163-3: 2004, clase C, subclase 1

Equal leg angles[▼] (continued)

Dimensions: EN 10056-1: 1998
Tolerances: EN 10056-2: 1994
Surface condition: according to EN 10163-3: 2004, class C, subclass 1

Angolari a lati uguali[▼] (continua)

Dimensioni: EN 10056-1: 1998
Tolleranze: EN 10056-2: 1994
Condizioni di superficie: secondo EN 10163-3: 2004, classe C, sottoclasse 1

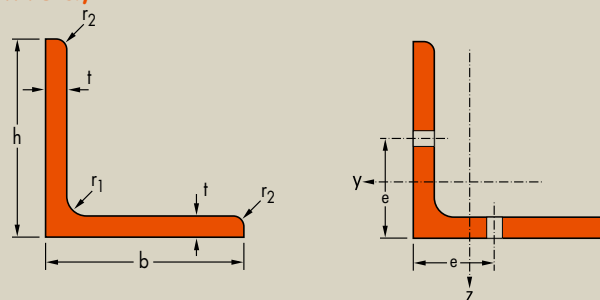

Denominación Designation Designazione	Dimensiones Dimensions Dimensioni				Dimensiones de construcción Dimensions for detailing Dimensioni di dettaglio					
	G kg/m	h=b mm	t mm	r ₁ mm	r ₂ mm	A mm ² x10 ²	Ø	e _{min} mm	e _{max} mm	A _{net} mm ² x10 ²
L 20 x 20 x 3 ⁻	0,879	20	3	3,5	2,0	1,12	-	-	-	-
L 25 x 25 x 3 ^{-/▲}	1,11	25	3	3,5	2,0	1,42	-	-	-	-
L 25 x 25 x 4 ^{-/▲}	1,45	25	4	3,5	2,0	1,85	-	-	-	-
L 30 x 30 x 3 ^{-/▲}	1,36	30	3	5	2,5	1,74	-	-	-	-
L 30 x 30 x 4 ^{-/▲}	1,78	30	4	5	2,5	2,27	-	-	-	-
L 35 x 35 x 4 ^{-/▲}	2,09	35	4	5	2,5	2,67	-	-	-	-
L 40 x 40 x 4 ^{-/▲}	2,42	40	4	6	3,0	3,08	-	-	-	-
L 40 x 40 x 5 ^{-/▲}	2,97	40	5	6	3,0	3,79	-	-	-	-
L 45 x 45 x 4 ^{*/▲}	2,74	45	4	7	3,5	3,49	-	-	-	-
L 45 x 45 x 4,5 ^{*-/▲}	3,06	45	4,5	7	3,5	3,90	-	-	-	-
L 45 x 45 x 5 ^{*/▲}	3,38	45	5	7	3,5	4,30	-	-	-	-
L 50 x 50 x 4 ^{-/▲}	3,06	50	4	7	3,5	3,89	-	-	-	-
L 50 x 50 x 5 ^{-/▲}	3,77	50	5	7	3,5	4,80	-	-	-	-
L 50 x 50 x 6 ^{-/▲}	4,47	50	6	7	3,5	5,69	-	-	-	-
L 50 x 50 x 7 ^{-/▲}	5,15	50	7	7	3,5	6,56	-	-	-	-
L 55 x 55 x 5 ^{*/▶}	4,18	55	5	8	4,0	5,32	-	-	-	-
L 55 x 55 x 6 ^{*/▲}	4,95	55	6	8	4,0	6,31	-	-	-	-
L 60 x 60 x 4 [*]	3,70	60	4	8	4,0	4,71	M 12	34	40,5	4,15
L 60 x 60 x 5 ^{-/▲}	4,57	60	5	8	4,0	5,82	M 12	35	40,5	5,12
L 60 x 60 x 6 ^{-/▲}	5,42	60	6	8	4,0	6,91	M 12	36	40,5	6,07
L 60 x 60 x 8 ^{-/▲}	7,09	60	8	8	4,0	9,03	M 12	38	40,5	7,91
L 65 x 65 x 6 ^{*/▶}	5,91	65	6	9	4,5	7,53	M 16	36	38	6,45
L 65 x 65 x 7 ⁻	6,83	65	7	9	4,5	8,70	M 16	37	38	7,44
L 65 x 65 x 8 ^{*/▶}	7,73	65	8	9	4,5	9,85	M 16	38	38	8,41

- ▼ Otras dimensiones previa solicitud. Según el proceso de laminación el radio r₂ puede tener dimensiones inferiores.
- * Tonelaje mínimo y condiciones de suministro previo acuerdo.
- + Pedido mínimo: 40 t por perfil y calidad o según acuerdo.
- Perfil conforme a EN 10056-1: 1998.
- ▲ Perfil conforme a DIN 1028: 1994.
- ▶ Perfil conforme a CSN 42 5541: 1974.
- ▲ Disponible con aristas vivas.

- ▼ Other dimensions on request. The r₂ radius may be smaller depending on the rolling process.
- * Minimum tonnage and delivery conditions upon agreement.
- + Minimum order: 40t per section and grade or upon agreement.
- Section in accordance with EN 10056-1: 1998.
- ▲ Section in accordance with DIN 1028: 1994.
- ▶ Section in accordance with CSN 42 5541: 1974.
- ▲ Available with sharp edges.

- ▼ Dimensioni di dettaglio disponibili su richiesta. Il raggio r₂ può essere minore a seconda del processo di laminazione.
- * Tonnellaggio minimo e condizioni di fornitura da concordare.
- + Ordine minimo: 40t per sezione e qualità o da concordare.
- Sezione conforme a EN 10056-1: 1998.
- ▲ Sezione conforme a DIN 1028: 1994.
- ▶ Sezione conforme a CSN 42 5541: 1974.
- ▲ Disponibile con spigoli vivi.



Páginas de notaciones 199-203 / Notations pages 199-203 / Pagine di annotazioni 199-203

Denominación Designation Designazione	Dimensiones Dimensions Dimensioni				A mm ² x10 ²	Dimensiones de construcción Dimensions for detailing Dimensioni di dettaglio				
	G kg/m	h=b mm	t mm	r ₁ mm		r ₂ mm	Ø	e _{min} mm	e _{max} mm	A _{net} mm ² x10 ²
L 70 x 70 x 6 ⁻	6,38	70	6	9	4,5	8,13	M 16	36	43	7,05
L 70 x 70 x 7 ⁻	7,38	70	7	9	4,5	9,40	M 16	37	43	8,14
L 70 x 70 x 8 ^{*/▶}	8,37	70	8	10	5,0	10,7	M 16	38	43	9,23
L 70 x 70 x 9 ^{*/◀}	9,32	70	9	9	4,5	11,9	M 16	39	43	10,3
L 75 x 75 x 4 [*]	4,65	75	4	9	4,5	5,93	M 16	34	48	5,21
L 75 x 75 x 5 [*]	5,76	75	5	9	4,5	7,34	M 16	35	48	6,44
L 75 x 75 x 6 ⁻	6,85	75	6	9	4,5	8,73	M 16	36	48	7,65
L 75 x 75 x 7 [*]	7,93	75	7	9	4,5	10,1	M 16	37	48	8,84
L 75 x 75 x 8 ⁻	8,99	75	8	9	4,5	11,4	M 16	38	48	10,0
L 75 x 75 x 10 [*]	11,1	75	10	9	4,5	14,1	M 16	40	48	12,3
L 80 x 80 x 5 [*]	6,17	80	5	10	5,0	7,86	M 16	35	53	6,96
L 80 x 80 x 6 ^{*/◀}	7,34	80	6	10	5,0	9,35	M 16	36	53	8,27
L 80 x 80 x 7 [*]	8,49	80	7	10	5,0	10,8	M 16	37	53	9,56
L 80 x 80 x 8 ⁻	9,63	80	8	10	5,0	12,3	M 16	38	53	10,8
L 80 x 80 x 10 ⁻	11,9	80	10	10	5,0	15,1	M 16	40	53	13,3
L 90 x 90 x 6 ^{*/▶}	8,28	90	6	10	5,0	10,5	M 24	46	51	8,99
L 90 x 90 x 7 ⁻	9,61	90	7	11	5,5	12,2	M 24	47	51	10,4
L 90 x 90 x 8 ⁻	10,9	90	8	11	5,5	13,9	M 24	48	51	11,8
L 90 x 90 x 9 ⁻	12,2	90	9	11	5,5	15,5	M 24	49	51	13,2
L 90 x 90 x 10 ⁻	13,4	90	10	11	5,5	17,1	M 24	50	51	14,5
L 90 x 90 x 11 [*]	14,7	90	11	11	5,5	18,7	M 24	51	51	15,9
L 100 x 100 x 6 ^{*/▶}	9,26	100	6	12	6,0	11,8	M 27	46	53	10,0
L 100 x 100 x 7 [*]	10,7	100	7	12	6,0	13,7	M 27	47	53	11,6
L 100 x 100 x 8 ^{*/-}	12,2	100	8	12	6,0	15,5	M 27	48	53	13,1
L 100 x 100 x 10 ^{*/-}	15,0	100	10	12	6,0	19,2	M 27	50	53	16,2
L 100 x 100 x 12 ^{*/-}	17,8	100	12	12	6,0	22,7	M 27	52	53	19,1
L 110 x 110 x 8 ^{*/▶}	13,4	110	8	12	6,0	17,1	M 27	48	62	14,7
L 110 x 110 x 10 ^{*/◀}	16,6	110	10	13	6,5	21,2	M 27	50	62	18,2
L 110 x 110 x 12 [*]	19,7	110	12	13	6,5	25,1	M 27	52	62	21,5

Perfiles angulares de lados iguales[▼] (continúa)

Dimensiones: EN 10056-1: 1998
Tolerancias: EN 10056-2: 1994
Estado de la superficie: conforme a norma EN 10163-3: 2004, clase C, subclase 1

Equal leg angles[▼] (continued)

Dimensions: EN 10056-1: 1998
Tolerances: EN 10056-2: 1994
Surface condition: according to EN 10163-3: 2004, class C, subclass 1

Angolari a lati uguali[▼] (continua)

Dimensioni: EN 10056-1: 1998
Tolleranze: EN 10056-2: 1994
Condizioni di superficie: secondo EN 10163-3: 2004, classe C, sottoclasse 1

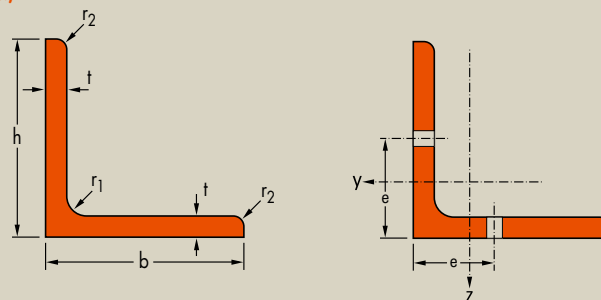

Denominación Designation Designazione	Dimensiones Dimensions Dimensioni				A mm ² x10 ²	Ø	Dimensiones de construcción Dimensions for detailing Dimensioni di dettaglio			
	G kg/m	h=b mm	t mm	r ₁ mm			r ₂ mm	e _{min} mm	e _{max} mm	A _{net} mm ² x10 ²
L 120 x 120 x 8 ^{*/▶/♣}	14,7	120	8	13	6,5	18,7	M 27	48	72	16,3
L 120 x 120 x 10 ^{*/♣}	18,2	120	10	13	6,5	23,2	M 27	50	72	20,2
L 120 x 120 x 11 ^{♣/♠}	19,9	120	11	13	6,5	25,4	M 27	51	72	22,1
L 120 x 120 x 12 ^{*/♣}	21,6	120	12	13	6,5	27,5	M 27	52	72	23,9
L 120 x 120 x 13 ^{*/♣}	23,3	120	13	13	6,5	29,7	M 27	53	72	25,8
L 120 x 120 x 15 ^{*/♣}	26,6	120	15	13	6,5	33,9	M 27	55	72	29,4
L 130 x 130 x 10 ^{*/♣}	19,8	130	10	14	7,0	25,2	M 27	50	82	22,2
L 130 x 130 x 12 ^{*/♣}	23,5	130	12	14	7,0	30,0	M 27	52	82	26,4
L 130 x 130 x 13 ^{*/♣}	25,4	130	13	14	7,0	32,3	M 27	53	82	28,4
L 130 x 130 x 14 ^{*/▶/♣}	27,2	130	14	14	7,0	34,7	M 27	54	82	30,5
L 130 x 130 x 16 ^{*/♣}	30,8	130	16	14	7,0	39,3	M 27	56	82	34,5
L 150 x 150 x 10 ^{*/♣}	23,0	150	10	16	8,0	29,3	M 27	52	102	26,3
L 150 x 150 x 12 ^{*/♣}	27,3	150	12	16	8,0	34,8	M 27	54	102	31,2
L 150 x 150 x 14 ^{*/♣/♠}	31,6	150	14	16	8,0	40,3	M 27	56	102	36,1
L 150 x 150 x 15 ^{*/♣}	33,8	150	15	16	8,0	43,0	M 27	57	102	38,5
L 150 x 150 x 18 ^{*/♣}	40,1	150	18	16	8,0	51,0	M 27	61	102	45,6
L 160 x 160 x 14 ^{*/♣}	33,9	160	14	17	8,5	43,2	M 27	57	111	39,0
L 160 x 160 x 15 ^{*/♣}	36,2	160	15	17	8,5	46,1	M 27	58	111	41,6
L 160 x 160 x 16 ^{*/♣}	38,4	160	16	17	8,5	49,0	M 27	60	111	44,2
L 160 x 160 x 17 ^{*/♣/♠}	40,7	160	17	17	8,5	51,8	M 27	61	111	46,7
L 180 x 180 x 13 ^{*/♣}	35,7	180	13	18	9,0	45,5	M 27	57	131	41,6
L 180 x 180 x 14 ^{*/♣}	38,3	180	14	18	9,0	48,8	M 27	58	131	44,6
L 180 x 180 x 15 ^{*/♣}	40,9	180	15	18	9,0	52,1	M 27	59	131	47,6
L 180 x 180 x 16 ^{*/♣}	43,5	180	16	18	9,0	55,4	M 27	61	131	50,6
L 180 x 180 x 17 ^{*/♣}	46,0	180	17	18	9,0	58,7	M 27	62	131	53,6
L 180 x 180 x 18 ^{*/♣}	48,6	180	18	18	9,0	61,9	M 27	63	131	56,5
L 180 x 180 x 19 ^{*/♣}	51,1	180	19	18	9,0	65,1	M 27	64	131	59,4
L 180 x 180 x 20 ^{*/♣}	53,7	180	20	18	9,0	68,3	M 27	65	131	62,3

▼ Otras dimensiones previa solicitud. Según el proceso de laminación el radio r₂ puede tener dimensiones inferiores.
* Tonelaje mínimo y condiciones de suministro previo acuerdo.
+ Pedido mínimo: 40 t por perfil y calidad o según acuerdo.
- Perfil conforme a EN 10056-1: 1998.
♣ Perfil conforme a DIN 1028: 1994.
▶ Perfil conforme a CSN 42 5541: 1974.
▲ Disponible con aristas vivas.
x Perfil S460M disponible previa solicitud.

▼ Other dimensions on request. The r₂ radius may be smaller depending on the rolling process.
* Minimum tonnage and delivery conditions upon agreement.
+ Minimum order: 40t per section and grade or upon agreement.
- Section in accordance with EN 10056-1: 1998.
♣ Section in accordance with DIN 1028: 1994.
▶ Section in accordance with CSN 42 5541: 1974.
▲ Available with sharp edges.
x Section available in S460M upon agreement.

▼ Dimensioni di dettaglio disponibili su richiesta. Il raggio r₂ può essere minore a seconda del processo di laminazione.
* Tonnellaggio minimo e condizioni di fornitura da concordare.
+ Ordine minimo: 40t per sezione e qualità o da concordare.
- Sezione conforme a EN 10056-1: 1998.
♣ Sezione conforme a DIN 1028: 1994.
▶ Sezione conforme a CSN 42 5541: 1974.
▲ Disponibile con spigoli vivi.
x Sezione S460M disponibile su richiesta.



Páginas de notaciones 199-203 / Notations pages 199-203 / Pagine di annotazioni 199-203

Denominación Designation Designazione	Dimensiones Dimensions Dimensioni				A mm ² x10 ²	Dimensiones de construcción Dimensions for detailing Dimensioni di dettaglio				
	G kg/m	h=b mm	t mm	r ₁ mm		r ₂ mm	Ø	e _{min} mm	e _{max} mm	A _{net} mm ² x10 ²
L 200 x 200 x 15 ^{+/-x}	45,6	200	15	18	9,0	58,1	M 27	59	151	53,6
L 200 x 200 x 16 ^{+/-x}	48,5	200	16	18	9,0	61,8	M 27	61	151	57,0
L 200 x 200 x 17 ^{+/-x}	51,4	200	17	18	9,0	65,5	M 27	62	151	60,4
L 200 x 200 x 18 ^{+/-x}	54,2	200	18	18	9,0	69,1	M 27	63	151	63,7
L 200 x 200 x 19 ^{+/-x}	57,1	200	19	18	9,0	72,7	M 27	64	151	67,0
L 200 x 200 x 20 ^{+/-x}	59,9	200	20	18	9,0	76,3	M 27	65	151	70,3
L 200 x 200 x 21 ^{+/-x}	62,8	200	21	18	9,0	79,9	M 27	66	151	73,6
L 200 x 200 x 22 ^{+/-x}	65,6	200	22	18	9,0	83,5	M 27	67	151	76,9
L 200 x 200 x 23 ^{+/-x}	68,3	200	23	18	9,0	87,1	M 27	68	151	80,2
L 200 x 200 x 24 ^{+/-x}	71,1	200	24	18	9,0	90,6	M 27	69	151	83,4
L 200 x 200 x 25 ^{+/-x}	73,9	200	25	18	9,0	94,1	M 27	70	151	86,6
L 200 x 200 x 26 ^{+/-x}	76,6	200	26	18	9,0	97,6	M 27	71	151	89,8
L 250 x 250 x 20 ⁺	75,6	250	20	18	9,0	96,3	M 27	40	240	90,3
L 250 x 250 x 21 ⁺	79,2	250	21	18	9,0	101	M 27	41	246	94,6
L 250 x 250 x 22 ⁺	82,8	250	22	18	9,0	106	M 27	42	246	98,9
L 250 x 250 x 23 ⁺	86,4	250	23	18	9,0	110	M 27	43	246	103
L 250 x 250 x 24 ⁺	90,0	250	24	18	9,0	115	M 27	44	246	107
L 250 x 250 x 25 ⁺	93,5	250	25	18	9,0	119	M 27	45	246	112
L 250 x 250 x 26 ⁺	97,0	250	26	18	9,0	124	M 27	46	246	116
L 250 x 250 x 27 ⁺	101	250	27	18	9,0	128	M 27	47	246	120
L 250 x 250 x 28 ^{+/-}	104	250	28	18	9,0	133	M 27	48	246	124
L 250 x 250 x 35 ^{+/-}	128	250	35	18	9,0	163	M 27	78	205	153

Perfiles angulares de lados desiguales ▼

Dimensiones: EN 10056-1: 1998

Tolerancias: EN 10056-2: 1994

Estado de la superficie: conforme a norma EN 10163-3: 2004, clase C, subclase 1

Unequal leg angles ▼

Dimensions: EN 10056-1: 1998

Tolerances: EN 10056-2: 1994

Surface condition: according to EN 10163-3: 2004, class C, subclass 1

Angolari a lati diseguali ▼

Dimensioni: EN 10056-1: 1998

Tolleranze: EN 10056-2: 1994

Condizioni di superficie: secondo EN 10163-3: 2004, classe C, sottoclasse 1

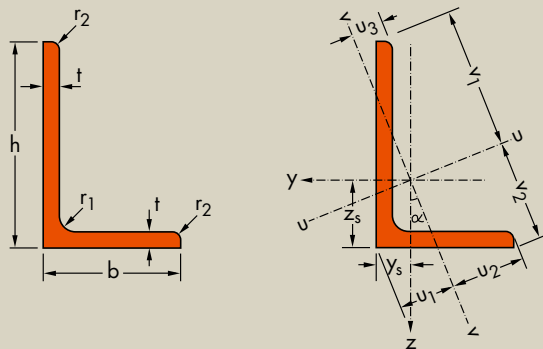

Denominación Designation Designazione	Dimensiones Dimensions Dimensioni						A	Posición de los ejes Position of axes Posizione degli assi							Superficie Surface Superficie	
	G kg/m	h mm	b mm	t mm	r ₁ mm	r ₂ mm		z _s mm x10	y _s mm x10	v ₁ mm x10	v ₂ mm x10	u ₁ mm x10	u ₂ mm x10	u ₃ mm x10	A _L m ² /m	A _G m ² /t
L 100 x 65 x 7 ⁻	8,77	100	65	7	10	5,0	11,2	3,23	1,51	6,83	4,90	2,64	3,44	1,66	0,321	36,66
L 100 x 65 x 8 ⁻	9,94	100	65	8	10	5,0	12,7	3,27	1,55	6,81	4,92	2,69	3,43	1,69	0,321	32,32
L 100 x 65 x 9 ⁺	11,1	100	65	9	10	5,0	14,1	3,32	1,59	6,78	4,94	2,74	3,42	1,72	0,321	28,94
L 100 x 65 x 10 ⁻	12,3	100	65	10	10	5,0	15,6	3,36	1,63	6,76	4,96	2,79	3,41	1,75	0,321	26,23
L 100 x 65 x 12	14,5	100	65	12	10	5,0	18,5	3,44	1,71	6,72	4,99	2,88	3,40	1,81	0,321	22,17
L 110 x 70 x 10 ⁺	13,4	110	70	10	10	5,0	17,1	3,69	1,72	7,43	5,38	2,96	3,73	1,84	0,351	26,17
L 110 x 70 x 12 ⁺	15,9	110	70	12	10	5,0	20,3	3,77	1,79	7,38	5,42	3,05	3,72	1,90	0,351	22,09
L 120 x 80 x 8 ^{-/x}	12,2	120	80	8	11	5,5	15,5	3,83	1,87	8,23	5,97	3,25	4,19	2,09	0,391	32,12
L 120 x 80 x 10 ^{-/x}	15,0	120	80	10	11	5,5	19,1	3,92	1,95	8,19	6,01	3,35	4,17	2,15	0,391	26,01
L 120 x 80 x 12 ^{-/x}	17,8	120	80	12	11	5,5	22,7	4,00	2,03	8,14	6,04	3,45	4,16	2,20	0,391	21,93
L 125 x 75 x 8 ^{-/x}	12,2	125	75	8	11	5,5	15,5	4,14	1,68	8,44	5,87	2,98	4,14	1,81	0,391	32,12
L 125 x 75 x 9 ⁺	13,6	125	75	9	11	5,5	17,3	4,18	1,72	8,41	5,89	3,03	4,12	1,84	0,391	28,73
L 125 x 75 x 10 ^{-/x}	15,0	125	75	10	11	5,5	19,1	4,23	1,76	8,38	5,91	3,08	4,11	1,87	0,391	26,01
L 125 x 75 x 12 ^{-/x}	17,8	125	75	12	11	5,5	22,7	4,31	1,84	8,33	5,96	3,17	4,09	1,93	0,391	21,93
L 130 x 90 x 10 ^{+/x}	16,6	130	90	10	11	5,0	21,2	4,16	2,19	8,93	6,67	3,75	4,62	2,49	0,431	25,96
L 130 x 90 x 12 ^{+/x}	19,7	130	90	12	12	6,0	25,1	4,24	2,26	8,90	6,69	3,84	4,59	2,51	0,430	21,80
L 130 x 90 x 14 ^{+/x}	22,8	130	90	14	11	5,0	29,0	4,33	2,34	8,85	6,73	3,95	4,61	2,60	0,431	18,94
L 140 x 90 x 8 ^{+/x}	14,0	140	90	8	11	5,5	17,9	4,49	2,03	9,56	6,81	3,58	4,83	2,27	0,451	32,08
L 140 x 90 x 10 ^{+/x}	17,4	140	90	10	11	5,5	22,1	4,58	2,11	9,52	6,85	3,69	4,81	2,33	0,451	25,94
L 140 x 90 x 12 ^{+/x}	20,6	140	90	12	11	5,5	26,3	4,66	2,19	9,47	6,89	3,79	4,79	2,39	0,451	21,83
L 140 x 90 x 14 ^{+/x}	23,8	140	90	14	11	5,5	30,4	4,74	2,27	9,43	6,92	3,88	4,78	2,45	0,451	18,90

- ▼ Otras dimensiones previa solicitud. Según el proceso de laminación el radio r₂ puede tener dimensiones inferiores.
- * Tonelaje mínimo y condiciones de suministro previo acuerdo.
- + Pedido mínimo: 40 t por perfil y calidad o según acuerdo.
- Perfil conforme a EN 10056-1: 1998.
- ▲ Perfil conforme a DIN 1029: 1994
- Perfil conforme a CSN 42 5541: 1974.
- x Perfil S460M disponible previa solicitud.

- ▼ Other dimensions on request. The r₂ radius may be smaller depending on the rolling process.
- * Minimum tonnage and delivery conditions upon agreement.
- + Minimum order: 40t per section and grade or upon agreement.
- Section in accordance with EN 10056-1: 1998.
- ▲ Profilé conforme à DIN 1029: 1994
- Section in accordance with CSN 42 5541: 1974.
- x Section available in S460M upon agreement.

- ▼ Dimensioni di dettaglio disponibili su richiesta. Il raggio r₂ può essere minore a seconda del processo di laminazione.
- * Tonnellaggio minimo e condizioni di fornitura da concordare.
- + Ordine minimo: 40t per sezione e qualità o da concordare.
- Sezione conforme a EN 10056-1: 1998.
- ▲ Sezione conforme a DIN 1028: 1994
- Sezione conforme a CSN 42 5541: 1974.
- x Sezione S460M disponibile su richiesta.



Páginas de notaciones 199-203 / Notations pages 199-203 / Pagine di annotazioni 199-203

Denominación Designation Designazione	Propiedades del perfil / Section properties / Proprietà geometriche del profilo												Classification EN 1993-1-1: 2005		EN 10025-2: 2004	EN 10025-4: 2004	EN 10225:2001	
	eje y-y axis y-y asse y-y			eje z-z axis z-z asse z-z			eje u-u axis u-u asse u-u		eje v-v axis v-v asse v-v				Pure compression					
	G	I_y	W_{ely}	i_y	I_z	W_{elz}	i_z	I_u	i_u	I_v	i_v	I_{yz}	α	S235				S355
kg/m	mm ⁴ x10 ⁴	mm ³ x10 ³	mm x10	mm ⁴ x10 ⁴	mm ³ x10 ³	mm x10	mm ⁴ x10 ⁴	mm x10	mm ⁴ x10 ⁴	mm x10	mm ⁴ x10 ⁴	°						
L 100 x 65 x 7	8,8	112,5	16,61	3,17	37,58	7,53	1,83	128,2	3,39	21,89	1,40	-37,7	22,59	3	3	✓		
L 100 x 65 x 8	9,9	126,8	18,85	3,16	42,23	8,54	1,83	144,4	3,38	24,66	1,40	-42,4	22,53	3	3	✓		
L 100 x 65 x 9	11,1	140,6	21,05	3,15	46,70	9,52	1,82	160,0	3,36	27,37	1,39	-46,8	22,44	1	3	✓		
L 100 x 65 x 10	12,3	154,0	23,20	3,14	50,98	10,48	1,81	175,0	3,35	30,03	1,39	-51,0	22,35	1	2	✓		
L 100 x 65 x 12	14,5	179,6	27,38	3,12	59,07	12,33	1,79	203,4	3,32	35,23	1,38	-58,7	22,11	1	1	✓		
L 110 x 70 x 10	13,4	206,6	28,27	3,48	65,07	12,31	1,95	233,2	3,69	38,54	1,50	-66,8	21,67	1	3	✓		
L 110 x 70 x 12	15,9	241,5	33,40	3,45	75,54	14,51	1,93	271,8	3,66	45,22	1,49	-77,1	21,46	1	2	✓		
L 120 x 80 x 8	12,2	225,7	27,63	3,82	80,76	13,17	2,28	260,0	4,10	46,39	1,73	-78,5	23,65	3	4	✓		
L 120 x 80 x 10	15,0	275,5	34,10	3,80	98,11	16,21	2,26	317,0	4,07	56,60	1,72	-95,3	23,53	2	3	✓		
L 120 x 80 x 12	17,8	322,8	40,37	3,77	114,3	19,14	2,24	370,7	4,04	66,45	1,71	-110,8	23,37	1	2	✓		
L 125 x 75 x 8	12,2	247,3	29,57	4,00	67,61	11,61	2,09	274,2	4,21	40,71	1,62	-74,5	19,84	3	4	✓		
L 125 x 75 x 9	13,6	275,0	33,06	3,98	74,96	12,97	2,08	304,8	4,19	45,23	1,62	-82,7	19,78	3	3	✓		
L 125 x 75 x 10	15,0	302,0	36,50	3,97	82,05	14,29	2,07	334,4	4,18	49,65	1,61	-90,4	19,71	3	3	✓		
L 125 x 75 x 12	17,8	354,0	43,22	3,95	95,52	16,87	2,05	391,2	4,15	58,28	1,60	-104,9	19,54	1	3	✓		
L 130 x 90 x 10	16,6	359,7	40,70	4,12	141,8	20,82	2,59	421,5	4,46	79,92	1,94	-131,6	25,19	3	3	✓		
L 130 x 90 x 12	19,7	420,4	47,97	4,09	164,5	24,42	2,56	491,6	4,42	93,31	1,93	-152,6	25,02	1	3	✓		
L 130 x 90 x 14	22,8	481,4	55,50	4,07	187,9	28,24	2,55	561,9	4,40	107,4	1,93	-173,5	24,89	1	2	✓		
L 140 x 90 x 8	14,0	360,0	37,86	4,49	118,2	16,96	2,57	409,3	4,78	68,90	1,96	-119,8	22,38	4	4	✓		
L 140 x 90 x 10	17,4	440,9	46,81	4,46	144,1	20,91	2,55	500,8	4,76	84,19	1,95	-146,2	22,28	3	3	✓		
L 140 x 90 x 12	20,6	518,1	55,50	4,44	168,4	24,72	2,53	587,6	4,73	98,93	1,94	-170,6	22,15	2	3	✓		
L 140 x 90 x 14	23,8	591,9	63,96	4,41	191,3	28,41	2,51	670,0	4,70	113,3	1,93	-193,3	21,99	1	3	✓		

Perfiles angulares de lados desiguales[▼] (continúa)

Dimensiones: EN 10056-1: 1998
Tolerancias: EN 10056-2: 1994
Estado de la superficie: conforme a norma EN 10163-3: 2004, clase C, subclase 1

Unequal leg angles[▼] (continued)

Dimensions: EN 10056-1: 1998
Tolerances: EN 10056-2: 1994
Surface condition: according to EN 10163-3: 2004, class C, subclass 1

Angolari a lati diseguali[▼] (continua)

Dimensioni: EN 10056-1: 1998
Tolleranze: EN 10056-2: 1994
Condizioni di superficie: secondo EN 10163-3: 2004, classe C, sottoclasse 1

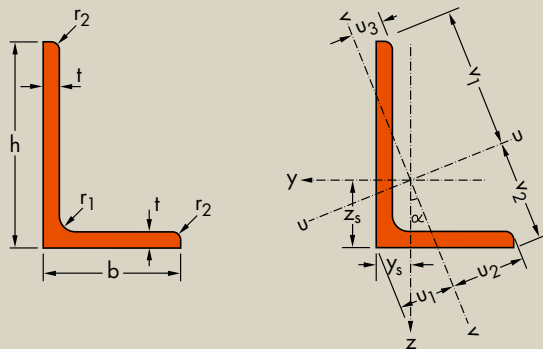

Denominación Designation Designazione	Dimensiones Dimensions Dimensioni						A	Posición de los ejes Position of axes Posizione degli assi							Superficie Surface Superficie	
	h	b	t	r ₁	r ₂	z _s		y _s	v ₁	v ₂	u ₁	u ₂	u ₃	A _L	A _G	
G kg/m	mm	mm	mm	mm	mm	mm ² x10 ²	mm x10	mm x10	mm x10	mm x10	mm x10	mm x10	mm x10	mm x10	m ² /m	m ² /t
L 150 x 75 x 9 ^{*/-/x}	15,4	150	75	9	12	6,0	19,6	5,26	1,57	9,82	6,59	2,85	4,41	1,61	0,440	28,59
L 150 x 75 x 10 ^{*/-/x}	17,0	150	75	10	12	6,0	21,7	5,31	1,61	9,78	6,62	2,90	4,39	1,65	0,440	25,87
L 150 x 75 x 11 ^{*/-/x}	18,6	150	75	11	12	6,0	23,7	5,35	1,65	9,75	6,65	2,95	4,37	1,68	0,440	23,64
L 150 x 75 x 12 ^{*/-/x}	20,2	150	75	12	12	6,0	25,7	5,40	1,69	9,72	6,68	2,99	4,36	1,72	0,440	21,78
L 150 x 90 x 10 ^{+/-/x}	18,2	150	90	10	12	6,0	23,2	5,00	2,04	10,10	7,07	3,61	4,97	2,20	0,470	25,84
L 150 x 90 x 11 ^{+/-/x}	19,9	150	90	11	12	6,0	25,3	5,04	2,08	10,07	7,09	3,66	4,95	2,23	0,470	23,61
L 150 x 100 x 10 ^{+/-/x}	19,0	150	100	10	12	6,0	24,2	4,81	2,34	10,27	7,48	4,08	5,25	2,64	0,490	25,83
L 150 x 100 x 12 ^{+/-/x}	22,5	150	100	12	12	6,0	28,7	4,90	2,42	10,23	7,52	4,18	5,23	2,70	0,490	21,72
L 150 x 100 x 14 ^{+/-/x}	26,1	150	100	14	12	6,0	33,2	4,98	2,50	10,19	7,55	4,28	5,22	2,75	0,490	18,79
L 200 x 100 x 10 ^{+/-/x}	23,0	200	100	10	15	7,5	29,2	6,93	2,01	13,15	8,74	3,72	5,94	2,09	0,587	25,58
L 200 x 100 x 12 ^{+/-/x}	27,3	200	100	12	15	7,5	34,8	7,03	2,10	13,08	8,81	3,82	5,89	2,17	0,587	21,49
L 200 x 100 x 14 ^{+/*/x}	31,6	200	100	14	15	7,5	40,3	7,12	2,18	13,01	8,86	3,91	5,85	2,24	0,587	18,57

- ▼ Otras dimensiones previa solicitud. Según el proceso de laminación el radio r₂ puede tener dimensiones inferiores.
- * Tonelaje mínimo y condiciones de suministro previo acuerdo.
- + Pedido mínimo: 40 t por perfil y calidad o según acuerdo.
- Perfil conforme a EN 10056-1: 1998.
- * Perfil conforme a DIN 1029: 1994
- ▶ Perfil conforme a CSN 42 5541: 1974.
- x Perfil S460M disponible previa solicitud.

- ▼ Other dimensions on request. The r₂ radius may be smaller depending on the rolling process.
- * Minimum tonnage and delivery conditions upon agreement.
- + Minimum order: 40t per section and grade or upon agreement.
- Section in accordance with EN 10056-1: 1998.
- * Profilé conforme à DIN 1029: 1994
- ▶ Section in accordance with CSN 42 5541: 1974.
- x Section available in S460M upon agreement.

- ▼ Dimensioni di dettaglio disponibili su richiesta. Il raggio r₂ può essere minore a seconda del processo di laminazione.
- * Tonnellaggio minimo e condizioni di fornitura da concordare.
- + Ordine minimo: 40t per sezione e qualità o da concordare.
- Sezione conforme a EN 10056-1: 1998.
- * Sezione conforme a DIN 1028: 1994
- ▶ Sezione conforme a CSN 42 5541: 1974.
- x Sezione S460M disponibile su richiesta.



Páginas de notaciones 199-203 / Notations pages 199-203 / Pagine di annotazioni 199-203

Denominación Designation Designazione	Propiedades del perfil / Section properties / Proprietà geometriche del profilo												Classification EN 1993-1-1: 2005		EN 10025-2: 2004	EN 10025-4: 2004	EN 10225:2001	
	eje y-y axis y-y asse y-y			eje z-z axis z-z asse z-z			eje u-u axis u-u asse u-u		eje v-v axis v-v asse v-v				Pure compression					
	G	I_y	W_{ely}	i_y	I_z	W_{elz}	i_z	I_u	i_u	I_v	i_v	I_{yz}	α	S235				S355
kg/m	mm ⁴ x10 ⁴	mm ³ x10 ³	mm x10	mm ⁴ x10 ⁴	mm ³ x10 ³	mm x10	mm ⁴ x10 ⁴	mm x10	mm ⁴ x10 ⁴	mm x10	mm ⁴ x10 ⁴	°						
L 150 x 75 x 9	15,4	455,2	46,74	4,82	77,91	13,14	1,99	483,2	4,97	49,95	1,60	-106,4	14,72	3	4	✓		
L 150 x 75 x 10	17,0	500,6	51,65	4,81	85,37	14,50	1,99	531,1	4,95	54,87	1,59	-116,6	14,66	3	4	✓		
L 150 x 75 x 11	18,6	545,0	56,49	4,80	92,57	15,83	1,98	577,9	4,94	59,70	1,59	-126,3	14,59	3	3	✓		
L 150 x 75 x 12	20,2	588,4	61,27	4,78	99,55	17,14	1,97	623,5	4,92	64,45	1,58	-135,6	14,51	3	3	✓		
L 150 x 90 x 10	18,2	533,1	53,29	4,80	146,1	20,98	2,51	591,3	5,05	87,93	1,95	-160,9	19,87	3	4	✓		
L 150 x 90 x 11	19,9	580,7	58,30	4,79	158,7	22,91	2,50	643,7	5,04	95,70	1,94	-174,7	19,81	3	3	✓		
L 150 x 100 x 10	19,0	552,6	54,23	4,78	198,5	25,92	2,87	637,3	5,14	113,8	2,17	-192,8	23,72	3	4	✓		
L 150 x 100 x 12	22,5	650,5	64,38	4,76	232,6	30,69	2,85	749,3	5,11	133,9	2,16	-225,9	23,61	3	3	✓		
L 150 x 100 x 14	26,1	744,4	74,27	4,74	264,9	35,32	2,82	855,9	5,08	153,4	2,15	-256,8	23,48	1	3	✓		
L 200 x 100 x 10	23,0	1219	93,24	6,46	210,3	26,33	2,68	1294	6,65	134,5	2,14	-286,8	14,82	4	4	✓		
L 200 x 100 x 12	27,3	1440	111,0	6,43	247,2	31,28	2,67	1529	6,63	158,5	2,13	-337,3	14,74	3	4	✓		
L 200 x 100 x 14	31,6	1654	128,4	6,41	282,2	36,08	2,65	1755	6,60	181,7	2,12	-384,8	14,65	3	4	✓		

Perfiles angulares de lados desiguales[▼] (continúa)

Dimensiones: EN 10056-1: 1998
Tolerancias: EN 10056-2: 1994
Estado de la superficie: conforme a norma EN 10163-3: 2004, clase C, subclase 1

Unequal leg angles[▼] (continued)

Dimensions: EN 10056-1: 1998
Tolerances: EN 10056-2: 1994
Surface condition: according to EN 10163-3: 2004, class C, subclass 1

Angolari a lati diseguali[▼] (continua)

Dimensioni: EN 10056-1: 1998
Tolleranze: EN 10056-2: 1994
Condizioni di superficie: secondo EN 10163-3: 2004, classe C, sottoclasse 1

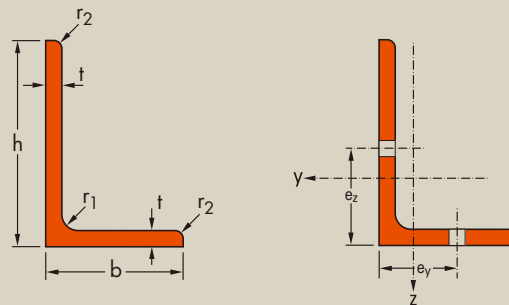

Denominación Designation Designazione	Dimensiones Dimensions Dimensioni						Dimensiones de construcción / Dimensions for detailing / Dimensioni di dettaglio								
	G kg/m	h mm	b mm	t mm	r ₁ mm	r ₂ mm	A mm ² x10 ²	lado largo / long leg / lato largo				lado corto / short leg / lato corto			
								Ø _z	e _{z,min} mm	e _{z,max} mm	A _{z,net} mm ² x10 ²	Ø _y	e _{y,min} mm	e _{y,max} mm	A _{y,net} mm ² x10 ²
L 100 x 65 x 7 ⁻	8,77	100	65	7	10	5,0	11,2	M 27	47	54	9,07	M 16	37	38	9,91
L 100 x 65 x 8 ⁻	9,94	100	65	8	10	5,0	12,7	M 27	48	54	10,3	M 16	38	38	11,2
L 100 x 65 x 9 ⁺	11,1	100	65	9	10	5,0	14,1	M 27	49	54	11,4	M 16	39	38	12,5
L 100 x 65 x 10 ⁻	12,3	100	65	10	10	5,0	15,6	M 27	50	54	12,6	M 16	40	38	13,8
L 100 x 65 x 12	14,5	100	65	12	10	5,0	18,5	M 27	52	54	14,9	M 16	42	38	16,3
L 110 x 70 x 10 ⁺	13,4	110	70	10	10	5,0	17,1	M 27	50	64	14,1	M 16	40	43	15,3
L 110 x 70 x 12 ⁺	15,9	110	70	12	10	5,0	20,3	M 27	52	64	16,7	M 16	42	43	18,1
L 120 x 80 x 8 ^{-/x}	12,2	120	80	8	11	5,5	15,5	M 27	48	73	13,1	M 16	38	52	14,0
L 120 x 80 x 10 ^{-/x}	15,0	120	80	10	11	5,5	19,1	M 27	50	73	16,1	M 16	40	52	17,3
L 120 x 80 x 12 ^{-/x}	17,8	120	80	12	11	5,5	22,7	M 27	52	73	19,1	M 16	42	52	20,5
L 125 x 75 x 8 ^{-/x}	12,2	125	75	8	11	5,5	15,5	M 27	48	78	13,1	M 16	38	47	14,0
L 125 x 75 x 9 ⁺	13,6	125	75	9	11	5,5	17,3	M 27	49	78	14,6	M 16	39	47	15,7
L 125 x 75 x 10 ^{-/x}	15,0	125	75	10	11	5,5	19,1	M 27	50	78	16,1	M 16	40	47	17,3
L 125 x 75 x 12 ^{-/x}	17,8	125	75	12	11	5,5	22,7	M 27	52	78	19,1	M 16	42	47	20,5
L 130 x 90 x 10 ^{+/x}	16,6	130	90	10	11	5,0	21,2	M 27	50	84	18,2	M 24	50	51	18,6
L 130 x 90 x 12 ^{+/x}	19,7	130	90	12	12	6,0	25,1	M 27	52	83	21,5	M 24	52	52	22,0
L 130 x 90 x 14 ^{+/x}	22,8	130	90	14	11	5,0	29,0	M 27	54	84	24,8	M 24	54	51	25,4
L 140 x 90 x 8 ^{+/x}	14,0	140	90	8	11	5,5	17,9	M 27	48	93	15,5	M 24	48	51	15,8
L 140 x 90 x 10 ^{+/x}	17,4	140	90	10	11	5,5	22,1	M 27	50	93	19,1	M 24	50	51	19,5
L 140 x 90 x 12 ^{+/x}	20,6	140	90	12	11	5,5	26,3	M 27	52	93	22,7	M 24	52	51	23,2
L 140 x 90 x 14 ^{+/x}	23,8	140	90	14	11	5,5	30,4	M 27	54	93	26,2	M 24	54	51	26,7
L 150 x 75 x 9 ^{+/x}	15,4	150	75	9	12	6,0	19,6	M 27	47	102	16,9	M 16	37	46	18,0
L 150 x 75 x 10 ^{+/x}	17,0	150	75	10	12	6,0	21,7	M 27	48	102	18,7	M 16	38	46	19,9
L 150 x 75 x 11 ^{+/x}	18,6	150	75	11	12	6,0	23,7	M 27	49	102	20,4	M 16	39	46	21,7
L 150 x 75 x 12 ^{+/x}	20,2	150	75	12	12	6,0	25,7	M 27	50	102	22,1	M 16	40	40	23,6

▼ Otras dimensiones previa solicitud. Según el proceso de laminación el radio r₂ puede tener dimensiones inferiores.
* Tonelaje mínimo y condiciones de suministro previo acuerdo.
+ Pedido mínimo: 40 t por perfil y calidad o según acuerdo.
- Perfil conforme a EN 10056-1: 1998.
* Perfil conforme a DIN 1029: 1994
▶ Perfil conforme a CSN 42 5541: 1974.
x Perfil S460M disponible previa solicitud.

▼ Other dimensions on request. The r₂ radius may be smaller depending on the rolling process.
* Minimum tonnage and delivery conditions upon agreement.
+ Minimum order: 40t per section and grade or upon agreement.
- Section in accordance with EN 10056-1: 1998.
* Profil conforme à DIN 1029: 1994
▶ Section in accordance with CSN 42 5541: 1974.
x Section available in S460M upon agreement.

▼ Dimensioni di dettaglio disponibili su richiesta. Il raggio r₂ può essere minore a seconda del processo di laminazione.
* Tonnellaggio minimo e condizioni di fornitura da concordare.
+ Ordine minimo: 40t per sezione e qualità o da concordare.
- Sezione conforme a EN 10056-1: 1998.
* Sezione conforme a DIN 1028: 1994
▶ Sezione conforme a CSN 42 5541: 1974.
x Sezione S460M disponibile su richiesta.



Páginas de notaciones 199-203 / Notations pages 199-203 / Pagine di annotazioni 199-203

Denominación Designation Designazione	Dimensiones Dimensions Dimensioni						Dimensiones de construcción / Dimensions for detailing / Dimensioni di dettaglio								
	G kg/m	h mm	b mm	t mm	r ₁ mm	r ₂ mm	A mm ² x10 ²	lado largo / long leg / lato largo				lado corto / short leg / lato corto			
Ø _z								e _{z,min} mm	e _{z,max} mm	A _{z,net} mm ² x10 ²	Ø _y	e _{y,min} mm	e _{y,max} mm	A _{y,net} mm ² x10 ²	
L 150 x 90 x 10 ^{+/-x}	18,2	150	90	10	12	6,0	23,2	M 27	50	102	20,2	M 24	47	49	20,6
L 150 x 90 x 11 ^{+/-x}	19,9	150	90	11	12	6,0	25,3	M 27	51	102	22,0	M 24	48	49	22,5
L 150 x 100 x 10 ^{-/+x}	19,0	150	100	10	12	6,0	24,2	M 27	50	102	21,2	M 27	50	53	21,2
L 150 x 100 x 12 ^{-/+x}	22,5	150	100	12	12	6,0	28,7	M 27	52	102	25,1	M 27	52	53	25,1
L 150 x 100 x 14 ^{+/-x}	26,1	150	100	14	12	6,0	33,2	M 27	54	102	29,0	M 24	51	59	29,6
L 200 x 100 x 10 ^{-/+x}	23,0	200	100	10	15	7,5	29,2	M 27	54	150	26,2	M 27	51	53	26,2
L 200 x 100 x 12 ^{-/+x}	27,3	200	100	12	15	7,5	34,8	M 27	54	150	31,2	M 27	53	53	31,2
L 200 x 100 x 14 ^{+/-x}	31,6	200	100	14	15	7,5	40,3	M 27	55	151	36,1	M 24	52	59	36,6

Pletinas y llantas estrechas + pletinas y llantas

Dimensiones: EU 79-69 y EN 10058: 2003 (Pletinas y llantas estrechas)
 Tolerancias: EN 10058: 2003 (Pletinas y llantas estrechas)
 EU 91-81 Pletinas y llantas anchas
 Estado de la superficie: conforme a norma EN 10163-3: 2004, clase C, subclase 1

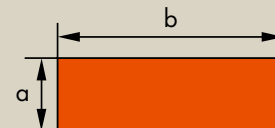

Narrow flat bars + Flat bars

Dimensions: EU 79-69 and EN 10058: 2003 (Narrow flats)
 Tolerances: EN 10058: 2003 (Narrow flats)
 EU 91-81 Wide flats
 Surface condition: according to EN 10163-3: 2004, class C, subclass 1

Piatti e larghi piatti

Dimensioni: EU 79-69 e EN 10058: 2003 (piatti stretti)
 Tolleranze: EN 10058: 2003 (piatti stretti)
 EU 91-81 Piatti larghi
 Condizioni di superficie: secondo EN 10163-3: 2004, classe C, sottoclasse 1

		Masa / Mass / Massa kg/m																		EN 10025-2: 2004
Ancho Width Larghezza b mm	Espesor Thickness Spessore a mm																			
		5	6	7	8	10	12	14	15	16	18	20	25	30	35	40	45	50	60	
Pletinas y llantas estrechas Narrow flat bars Piatti	→20	0,785	0,942	1,10	1,26	1,57	1,88	2,20	2,36											✓
	→25	0,981	1,18	1,37	1,57	1,96	2,36	2,75	2,94	3,14	3,53									✓
	→30	1,18	1,41	1,65	1,88	2,36	2,83	3,30	3,53	3,77	4,24	4,71								✓
	→35	1,37	1,65	1,92	2,20	2,75	3,30	3,85	4,12	4,40	4,95	5,50	6,87							✓
	→40	1,57	1,88	2,20	2,51	3,14	3,77	4,40	4,71	5,02	5,65	6,28	7,85	9,42						✓
	→45	1,77	2,12	2,47	2,83	3,53	4,24	4,95	5,30	5,65	6,36	7,07	8,83	10,6						✓
	→50	1,96	2,36	2,75	3,14	3,93	4,71	5,50	5,89	6,28	7,07	7,85	9,81	11,8	13,7					✓
	→60	2,36	2,83	3,30	3,77	4,71	5,65	6,59	7,07	7,54	8,48	9,42	11,8	14,1	16,5	18,8				✓
	→70	2,75	3,30	3,85	4,40	5,50	6,59	7,69	8,24	8,79	9,89	11,0	13,7	16,5	19,2	22,0	24,7	27,5		✓
	→80	3,14	3,77	4,40	5,02	6,28	7,54	8,79	9,42	10,0	11,3	12,6	15,7	18,8	22,0	25,1	28,3	31,4		✓
	→90	3,53	4,24	4,95	5,65	7,07	8,48	9,89	10,6	11,3	12,7	14,1	17,7	21,2	24,7	28,3	31,8	35,3		✓
	→100	3,93	4,71	5,50	6,28	7,85	9,42	11,0	11,8	12,6	14,1	15,7	19,6	23,6	27,5	31,4	35,3			✓
	→110				6,91	8,64	10,4	12,1	13,0	13,8	15,5	17,3	21,6	25,9	30,2	34,5				✓
→120				7,54	9,42	11,3	13,2	14,1	15,1	17,0	18,8	23,6	28,3						✓	
→130				8,16	10,2	12,3	14,3	15,3	16,3	18,4	20,4	25,5	30,6	35,7	40,8	45,9	51,0	62,2	✓	
→140				8,79	11,0	13,2	15,4	16,5	17,6	19,8	22,0	27,5	33,0	38,5	44,0	49,5	55,0	65,9	✓	
→150				9,42	11,8	14,1	16,5	17,7	18,8	21,2	23,6	29,4	35,3	41,2	47,1	53,0	58,9	70,7	✓	
Pletinas y llantas Flat bars Larghi piatti	→160				10,1	12,6	15,1	17,6	18,8	20,1	22,6	25,1	31,4	37,7	44,0	50,2	56,5	62,8	75,4	✓
	→170				10,7	13,3	16,0	18,7	20,0	21,4	24,0	26,7	33,4	40,0	46,7	53,4	60,1	66,7	80,1	✓
	→180				11,3	14,1	17,0	19,8	21,2	22,6	25,4	28,3	35,3							✓
	→200				12,6	15,7	18,8	22,0	23,6	25,1	28,3	31,4	39,3	47,1	55,0	62,8				✓
	*220					17,3	20,7		25,9			34,5	43,2	51,8	60,4	69,1				✓
	*250					19,6	23,6		29,4			39,3	49,1	58,9	68,7	78,5				✓
	*300					23,6	28,3		35,3			47,1	58,9	70,7	82,4	94,2				✓
*350					27,5	33,0		41,2			55,0	68,7	82,4	96,2	109,9				✓	
*400					31,4	37,7		47,1			62,8	78,5	94,2	109,9	125,6				✓	

- * Tonelaje mínimo y condiciones de suministro previo acuerdo.
- Otras dimensiones previa solicitud. Longitud: 6m. Peso de un paquete: ±200kg
- * Minimum tonnage and delivery conditions upon agreement.
- Other dimensions on request. Length: 6m. Bundle weight: ±200kg
- * Tonnellaggio minimo e condizioni di fornitura da concordare.
- Dimensioni di dettaglio disponibili su richiesta. Lunghezza: 6m. Peso imballo: ±200kg

Barras cuadradas

Dimensiones: EN 10059: 2003
Tolerancias: EN 10059: 2003
Estado de la superficie: conforme a norma EN 10163-3: 2004, clase C, subclase 1

Square bars

Dimensions: EN 10059: 2003
Tolerances: EN 10059: 2003
Surface condition: According to EN 10163-3: 2004, class C, subclass 1

Quadri

Dimensioni: EN 10059: 2003
Tolleranze: EN 10059: 2003
Condizioni di superficie: secondo EN 10163-3: 2004, classe C, sottoclasse 1

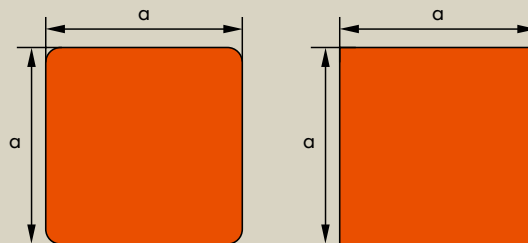

a x a	Aristas redondeadas Rounded edges Spigoli arrotondati	Aristas vivas Sharp edges Spigoli vivi	EN 10025-2: 2004
	Masa / Mass / Massa kg/m	Masa / Mass / Massa kg/m	
30 x 30*		7,07	✓
35 x 35*		9,62	✓
45 x 45*	15,7	15,9	✓
50 x 50*	19,4	19,6	✓
55 x 55*	23,5	23,7	✓
60 x 60*	27,9	28,3	✓
65 x 65*	32,7		✓
70 x 70*	38,0		✓
80 x 80*	49,6		✓
85 x 85*	56,0		✓
90 x 90*		63,6	✓
95 x 95*	69,9		✓
100 x 100*	77,5	78,5	✓
110 x 110*		95,0	✓
120 x 120*		113	✓
130 x 130*		133	✓
140 x 140*	153		✓
150 x 150*	173		✓
160 x 160*	200		✓

* Pedido mínimo: 40 t por perfil y calidad o según acuerdo.
* Minimum order: 40t per section and grade or upon agreement.
* Ordine minimo: 40t per sezione e qualità o da concordare.

Barras redondas de acero laminadas en caliente

Dimensiones: EN 10060: 2003
Tolerancias: EN 10060: 2003
Estado de la superficie: conforme a norma EN 10221: 1995, clase A

Hot rolled round steel bars

Dimensions: EN 10060: 2003
Tolerances: EN 10060: 2003
Surface condition: according to EN 10221: 1995, class A

Tondi laminati a caldo

Dimensioni: EN 10060: 2003
Tolleranze: EN 10060: 2003
Condizioni di superficie: conforme a EN 10221: 1995, classe A

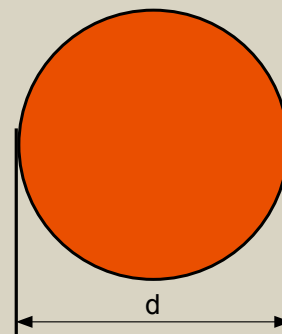

Denominación Designation Designazione	Diámetro Diameter Diametro	A	EN 10025-2: 2004	EN 10083: 2006	EN 10084: 1998
G	d	mm ² x10 ²			
kg/m	mm				

Denominación Designation Designazione	Diámetro Diameter Diametro	A	EN 10025-2: 2004	EN 10083: 2006	EN 10084: 1998
G	d	mm ² x10 ²			
kg/m	mm				

R 10*	0,617	10	0,785	✓	✓	✓
R 12*	0,888	12	1,13	✓	✓	✓
R 14*	1,21	14	1,54	✓	✓	✓
R 16*	1,58	16	2,01	✓	✓	✓
R 18*	2,00	18	2,54	✓	✓	✓
R 20*	2,47	20	3,14	✓	✓	✓
R 22*	2,98	22	3,80	✓	✓	✓
R 22.25*	3,05	22,25	3,89	✓	✓	✓
R 23.6*	3,43	23,6	4,37	✓	✓	✓
R 24*	3,55	24	4,52	✓	✓	✓
R 24.5*	3,70	24,5	4,71	✓	✓	✓
R 25*	3,85	25	4,91	✓		
R 26*	4,17	26	5,31	✓	✓	✓
R 26.7*	4,40	26,7	5,60	✓	✓	✓
R 27*	4,49	27	5,73	✓	✓	✓
R 28*	4,83	28	6,16	✓	✓	✓
R 29*	5,19	29	6,61	✓	✓	✓
R 29.5*	5,37	29,5	6,83	✓	✓	✓
R 29.7*	5,44	29,7	6,93	✓	✓	✓
R 30*	5,55	30	7,07	✓	✓	✓
R 31*	5,92	31	7,55	✓	✓	✓
R 32*	6,31	32	8,04	✓	✓	✓
R 34*	7,13	34	9,08	✓	✓	✓
R 34.4*	7,30	34,4	9,29	✓	✓	✓
R 35*	7,55	35	9,62	✓	✓	✓
R 35.7*	7,86	35,7	10,0	✓	✓	✓
R 36*	7,99	36	10,2	✓	✓	✓
R 37*	8,44	37	10,8	✓	✓	✓
R 38*	8,90	38	11,3	✓	✓	✓
R 39*	9,38	39	11,9	✓	✓	✓
R 39.2*	9,47	39,2	12,1	✓	✓	✓
R 40*	9,86	40	12,6	✓	✓	✓

R 42*	10,9	42	13,9	✓	✓	✓
R 44*	11,9	44	15,2	✓	✓	✓
R 45*	12,5	45	15,9	✓	✓	✓
R 46*	13,0	46	16,6	✓	✓	✓
R 47*	13,6	47	17,3	✓	✓	✓
R 48*	14,2	48	18,1	✓	✓	✓
R 49.2*	14,9	49,2	19,0	✓	✓	✓
R 50*	15,4	50	19,6	✓	✓	✓
R 51*	16,0	51	20,4	✓	✓	✓
R 52*	16,7	52	21,2	✓	✓	✓
R 53*	17,3	53	22,1	✓	✓	✓
R 54*	18,0	54	22,9	✓	✓	✓
R 55*	18,7	55	23,8	✓	✓	✓
R 55.8*	19,2	55,8	24,5	✓	✓	✓
R 56*	19,3	56	24,6	✓	✓	✓
R 57*	20,0	57	25,5	✓	✓	✓
R 58*	20,7	58	26,4	✓	✓	✓
R 59*	21,5	59	27,3	✓	✓	✓
R 60*	22,2	60	28,3	✓	✓	✓
R 62*	23,7	62	30,2	✓	✓	✓
R 63*	24,5	63	31,2	✓	✓	✓
R 65*	26,0	65	33,2	✓	✓	✓
R 70*	30,2	70	38,5	✓	✓	
R 75*	34,7	75	44,2	✓	✓	
R 80*	39,5	80	50,3	✓	✓	
R 85*	44,5	85	56,7	✓	✓	
R 90*	49,9	90	63,6	✓	✓	
R 95*	55,6	95	70,9	✓	✓	
R 100*	61,7	100	78,5	✓	✓	
R 105*	68,0	105	86,6	✓	✓	
R 110*	74,6	110	95,0	✓	✓	
R 120*	88,8	120	113	✓	✓	
R 130*	104	130	133	✓		

* Tonelaje mínimo y condiciones de suministro previo acuerdo.
* Minimum tonnage and delivery conditions upon agreement.
* Tonnellaggio minimo e condizioni di fornitura da concordare.

T en acero de alas iguales

Dimensiones: EN 10055: 1995
 Tolerancias: EN 10055: 1995
 Estado de la superficie: conforme a norma EN 10163-3: 2004, clase C, subclase 1

Equal flange tees

Dimensions: EN 10055: 1995
 Tolerances: EN 10055: 1995
 Surface condition: according to EN 10163-3: 2004, class C, subclass 1

Profili T ad ali uguali

Dimensioni: EN 10055: 1995
 Tolleranze: EN 10055: 1995
 Condizioni di superficie: secondo EN 10163-3: 2004, classe C, sottoclasse 1

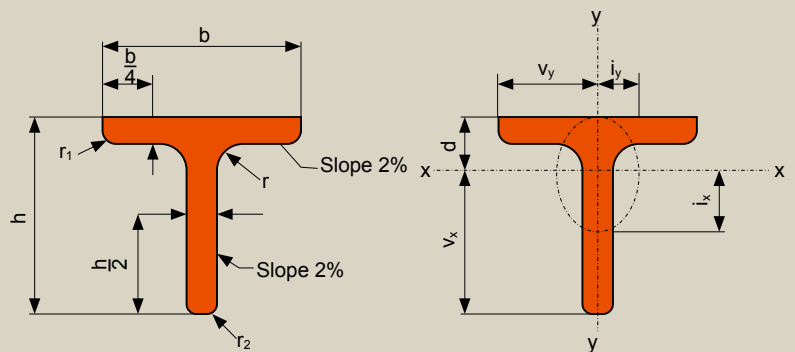

Páginas de notaciones 199-203 / Notations pages 199-203 / Pagine di annotazioni 199-203

Denominación Designation Designazione	Dimensiones Dimensions Dimensioni							Posición del eje x-x Position of axis x-x Posizione dell'asse x-x	Propiedades del perfil/ Section properties / Proprietà geometriche del profilo						Classification EN 1993-1-1: 2005 pure compression S235 S355		EN 10025-2: 2004	
	h	b	s=t	r	r ₁	r ₂	A		eje x-x axis x-x asse x-x			eje y-y axis y-y asse y-y						
G kg/m	mm	mm	mm	mm	mm	mm	mm ² x10 ²	d mm x10	I _x mm ⁴ x10 ⁴	I _x /V _x mm ³ x10 ³	i _x mm x10	I _y mm ⁴ x10 ⁴	I _y /V _y mm ³ x10 ³	i _y mm x10	1	1	✓	
T 30*	1,77	30	30	4	4	2	1	2,26	0,85	1,72	0,80	0,87	0,87	0,58	0,62	1	1	✓
T 35*	2,33	35	35	4,5	4,5	2,5	1	2,97	0,99	3,10	1,23	1,04	1,57	0,90	0,73	1	1	✓
T 40*	2,96	40	40	5	5	2,5	1	3,77	1,12	5,28	1,84	1,18	2,58	1,29	0,83	1	1	✓
T 50*	4,44	50	50	6	6	3	2	5,66	1,39	12,1	3,36	1,46	6,06	2,42	1,03	1	1	✓
T 60*	6,23	60	60	7	7	3,5	2	7,94	1,66	23,8	5,48	1,73	12,2	4,07	1,24	1	1	✓
T 70*	8,32	70	70	8	8	4	2	10,6	1,94	44,5	8,79	2,05	22,1	6,32	1,44	1	1	✓
T 80*	10,7	80	80	9	9	4,5	2	13,6	2,22	73,7	12,8	2,33	37,0	9,25	1,65	1	1	✓

* Tonelaje mínimo y condiciones de suministro previo acuerdo.
 * Minimum tonnage and delivery conditions upon agreement.
 * Tonnellaggio minimo e condizioni di fornitura da concordare.



Perfiles derivados y soluciones innovadoras

- 76 Vigas alveolares:
- con alvéolos circulares
 - con alvéolos hexagonales
 - con alvéolos octogonales
 - con alvéolos sinusoidales "Angelina®"
- 91 Perfiles IFB
- 93 Perfiles SFB

Derived Sections and innovative solutions

- 76 Castellated beams:
- with circular openings
 - with hexagonal openings
 - with octagonal openings
 - with sinusoidal openings "Angelina®"
- 91 IFB beams
- 93 SFB beams

Travi derivate e soluzioni innovative

- 76 Travi alveolari:
- con aperture circolari
 - con aperture esagonali
 - con aperture ottagonali
 - con aperture sinusoidali "Angelina®"
- 91 Travi IFB
- 93 Travi SFB



ACB – Vigas alveolares con alvéolos circulares

Dimensiones: Las dimensiones de las vigas alveolares son variables. Pueden optimizarse con ayuda del software ACB.

Ejecución de las soldaduras según diseño

Estado de la superficie: conforme a norma EN 10163-3: 2004, clase C, subclase 1

ACB – Castellated beams with circular openings

Dimensions: The dimensions of the castellated beams are variable. They can be optimised with the ACB software.

Execution of the welds according to design

Surface condition: according to EN 10163-3: 2004, class C, subclass 1

ACB - Travi alveolari con aperture circolari

Dimensioni: le dimensioni delle Travi alveolari sono variabili. Possono essere ottimizzate con il software ACB.

La esecuzione delle saldature dipende dal disegno

Condizioni di superficie: secondo EN 10163-3: 2004, classe C, sottoclasse 1

Perfil básico Base profile Profilo di base	IPE				
	Viga de techo / Roof beam / trave per copertura				
	(D ≈ 1,05 x h, w = 0,25 x D)*				
G kg/m	H mm	D mm	w mm	A _L m ² /m	

IPE A 200	17,1	290,4	210	52,5	0,699
IPE 200	20,7	293,4	210	52,5	0,706
IPE O 200	23,2	295,4	210	52,5	0,718
IPE A 220	20,6	320,1	230	57,5	0,774
IPE 220	24,3	323,1	230	57,5	0,780
IPE O 220	27,2	325,1	230	57,5	0,793
IPE A 240	24,3	349,7	250	62,5	0,843
IPE 240	28,5	352,7	250	62,5	0,849
IPE O 240	31,9	354,7	250	62,5	0,862
IPE A 270	28,6	394,3	280	70	0,954
IPE 270	33,5	397,3	280	70	0,961
IPE O 270	39,4	401,3	280	70	0,974
IPE A 300	34	441,2	315	78,75	1,065
IPE 300	39,2	444,2	315	78,75	1,071
IPE O 300	45,9	448,2	315	78,75	1,088
IPE A 330	40	488,2	350	87,5	1,150
IPE 330	45,7	491,2	350	87,5	1,156
IPE O 330	53,1	495,2	350	87,5	1,173
IPE A 360	46,9	533,3	380	95	1,242
IPE 360	53,1	535,7	380	95	1,248
IPE O 360	61,5	539,7	380	95	1,265

Jácena / Floor beam / trave per solaio	IPE				
	(D ≈ 1,05 x h, w = 0,5 x D)*				
	G kg/m	H mm	D mm	w mm	A _L m ² /m

Jácena / Floor beam / trave per solaio	17,4	275,6	205	105	0,719
Jácena / Floor beam / trave per solaio	21,1	279,9	210	110	0,724
Jácena / Floor beam / trave per solaio	23,7	283,6	210	105	0,736
Jácena / Floor beam / trave per solaio	21,0	305,6	230	120	0,794
Jácena / Floor beam / trave per solaio	24,8	308,6	230	120	0,800
Jácena / Floor beam / trave per solaio	27,8	312,2	230	115	0,812
Jácena / Floor beam / trave per solaio	24,8	334,3	250	130	0,866
Jácena / Floor beam / trave per solaio	29,2	337,3	250	130	0,872
Jácena / Floor beam / trave per solaio	32,6	340,9	250	125	0,884
Jácena / Floor beam / trave per solaio	29,2	378,9	280	140	0,980
Jácena / Floor beam / trave per solaio	34,2	383,3	285	145	0,986
Jácena / Floor beam / trave per solaio	40,2	385,9	280	140	0,998
Jácena / Floor beam / trave per solaio	34,7	420,3	310	160	1,095
Jácena / Floor beam / trave per solaio	40,1	427,8	315	155	1,100
Jácena / Floor beam / trave per solaio	46,9	431,1	315	157,5	1,116
Jácena / Floor beam / trave per solaio	40,9	466,3	345	175	1,184
Jácena / Floor beam / trave per solaio	46,8	469,3	345	175	1,190
Jácena / Floor beam / trave per solaio	54,3	476,2	350	175	1,205
Jácena / Floor beam / trave per solaio	48,0	511,4	375	185	1,279
Jácena / Floor beam / trave per solaio	54,3	515,2	380	190	1,283
Jácena / Floor beam / trave per solaio	62,9	519,2	380	190	1,299

* Ejemplo: posibilidad de otras geometrías.
h = altura del perfil de base

* Example: other geometries are possible.
h = height of base profile.

* Esempio: sono possibili altre geometrie.
h = altezza del profilo di base.

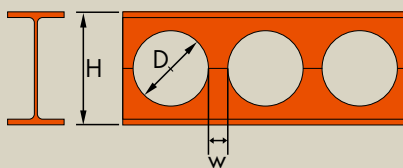

ACB

Páginas de notaciones 199-203 / Notations pages 199-203 / Pagine di annotazioni 199-203

IPE					
Perfil básico Base profile Profilo di base	Viga de techo / Roof beam / trave per copertura				
	(D ≈ 1,05 x h, w = 0,25 x D)*				
	G kg/m	H mm	D mm	w mm	A _L m ² /m

IPE A 400	53,6	592,1	420	105	1,345
IPE 400	61,7	595,1	420	105	1,352
IPE O 400	70,4	599,1	420	105	1,368
IPE A 450	62,6	668,7	475	118,75	1,469
IPE 450	71,9	671,7	475	118,75	1,476
IPE O 450	85,7	677,7	475	118,75	1,497
IPE A 500	73,8	742,9	525	131,25	1,596
IPE 500	84	745,9	525	131,25	1,603
IPE O 500	99,4	751,9	525	131,25	1,623
IPE A 550	85,6	819,5	580	145	1,715
IPE 550	97,5	822,5	580	145	1,722
IPE O 550	113,4	828,5	580	145	1,743
IPE A 600	99,9	893,7	630	157,5	1,841
IPE 600	113,1	896,7	630	157,5	1,848
IPE O 600	142,8	906,7	630	157,5	1,886
IPE 750 x 147	134,5	1127,2	790	197,5	2,301
IPE 750 x 173	159,9	1136,2	790	197,5	2,328
IPE 750 x 196	181,9	1144,2	790	197,5	2,348

IPE					
Perfil básico Base profile Profilo di base	Jácena / Floor beam / trave per solaio				
	(D ≈ 1,05 x h, w = 0,5 x D)*				
	G kg/m	H mm	D mm	w mm	A _L m ² /m

IPE A 400	54,8	568,2	415	205	1,386
IPE 400	63,1	572,6	420	210	1,391
IPE O 400	72,1	576,6	420	210	1,407
IPE A 450	64,1	639,7	470	240	1,517
IPE 450	73,7	647,1	475	235	1,521
IPE O 450	87,8	652,4	475	237,5	1,542
IPE A 500	75,6	712,9	520	260	1,647
IPE 500	86,1	717,3	525	265	1,653
IPE O 500	102,0	724	525	262,5	1,673
IPE A 550	87,7	787,4	575	285	1,772
IPE 550	100,1	791,9	580	290	1,778
IPE O 550	116,4	797,9	580	290	1,798
IPE A 600	102,5	857,6	625	315	1,904
IPE 600	116,2	862	630	320	1,909
IPE O 600	146,6	873,5	630	315	1,945
IPE 750 x 147	138,8	1084,3	790	400	2,379
IPE 750 x 173	164,6	1093,3	790	400	2,405
IPE 750 x 196	187,0	1102,8	790	395	2,425

* Ejemplo: posibilidad de otras geometrías.
h = altura del perfil de base.

* Example: other geometries are possible.
h = height of base profile.

* Esempio: sono possibili altre geometrie.
h = altezza del profilo di base.

ACB – Vigas alveolares con alvéolos circulares (continúa)

Dimensiones: Las dimensiones de las vigas alveolares son variables. Pueden optimizarse con ayuda del software ACB.

Ejecución de las soldaduras según diseño

Estado de la superficie: conforme a norma EN 10163-3: 2004, clase C, subclase 1

ACB – Castellated beams with circular openings (continued)

Dimensions: The dimensions of the castellated beams are variable. They can be optimised with the ACB software.

Execution of the welds according to design

Surface condition: according to EN 10163-3: 2004, class C, subclass 1

ACB - Travi alveolari con aperture circolari (continua)

Dimensioni: le dimensioni delle Travi alveolari sono variabili. Possono essere ottimizzate con il software ACB.

La esecuzione delle saldature dipende dal disegno

Condizioni di superficie: secondo EN 10163-3: 2004, classe C, sottoclasse 1

Perfil básico Base profile Profilo di base	HE				
	Viga de techo / Roof beam / trave per copertura				
	(D ≈ 1,05 x h, w = 0,25 x D)*				
G kg/m	H mm	D mm	w mm	A _L m ² /m	

HE 260 AA	51,7	368,9	275	68,75	1,395
HE 260 A	65,3	374,9	275	68,75	1,408
HE 260 B	89,2	384,9	275	68,75	1,429
HE 260 M	165,6	414,9	275	68,75	1,525
HE 280 AA	58,5	398,5	295	73,75	1,509
HE 280 A	73,2	404,5	295	73,75	1,522
HE 280 B	98,9	414,5	295	73,75	1,543
HE 280 M	181,1	444,5	295	73,75	1,639
HE 300 AA	66,6	427,2	315	78,75	1,617
HE 300 A	84,8	434,2	315	78,75	1,631
HE 300 B	112,4	444,2	315	78,75	1,653
HE 300 M	229,1	484,2	315	78,75	1,778
HE 320 AA	70,7	454,9	335	83,75	1,647
HE 320 A	93,6	463,9	335	83,75	1,666
HE 320 B	121,5	473,9	335	83,75	1,687
HE 320 M	235,6	512,9	335	83,75	1,806
HE 340 AA	74,9	486	360	90	1,678
HE 340 A	100,3	496	360	90	1,699
HE 340 B	128,5	506	360	90	1,720
HE 340 M	238,0	543	360	90	1,835
HE 360 AA	79,2	514,7	380	95	1,711
HE 360 A	107,1	525,7	380	95	1,734
HE 360 B	135,6	535,7	380	95	1,755
HE 360 M	239,9	570,7	380	95	1,861
HE 400 AA	87,3	573,1	420	105	1,778
HE 400 A	118,9	585,1	420	105	1,803
HE 400 B	148,0	595,1	420	105	1,824
HE 400 M	244,4	627,1	420	105	1,920

Jácena / Floor beam / trave per solaio	HE				
	(D ≈ 1,05 x h, w = 0,5 x D)*				
	G kg/m	H mm	D mm	w mm	A _L m ² /m

52,5	347,2	260	130	1,422
66,2	354,6	265	135	1,433
90,3	370,5	275	135	1,452
167,2	412	305	155	1,539
59,3	375,9	280	140	1,539
74,2	383,3	285	145	1,550
100,1	399,2	295	145	1,568
182,9	440,6	325	165	1,656
67,6	405,7	305	152,5	1,647
85,9	412	305	155	1,661
113,7	427,8	315	155	1,679
231,1	485,2	355	175	1,793
71,8	432,4	325	162,5	1,680
94,9	440,6	325	165	1,698
123,1	456,5	335	165	1,716
237,8	512,8	375	185	1,824
76,1	466,6	360	180	1,711
101,8	469,3	345	175	1,734
130,2	485,2	355	175	1,753
240,5	539,5	395	195	1,856
80,6	494,2	380	190	1,746
108,7	499,3	370	190	1,770
137,5	515,2	380	190	1,788
242,5	566,2	415	205	1,885
88,9	550,6	420	210	1,817
120,8	556,7	410	210	1,843
150,2	572,6	420	210	1,861
247,4	620,5	455	225	1,947

* Ejemplo: posibilidad de otras geometrías.
h = altura del perfil de base

* Example: other geometries are possible.
h = height of base profile.

* Esempio: sono possibili altre geometrie.
h = altezza del profilo di base.

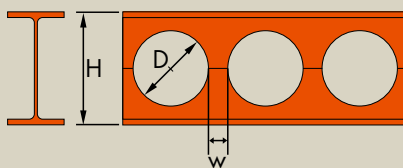

ACB

Páginas de notaciones 199-203 / Notations pages 199-203 / Pagine di annotazioni 199-203

HE					
Perfil básico Base profile Profilo di base	Viga de techo / Roof beam / trave per copertura				
	(D ≈ 1,05 x h, w = 0,25 x D)*				
	G kg/m	H mm	D mm	w mm	A _L m ² /m

HE					
	Jácena / Floor beam / trave per solaio				
	(D ≈ 1,05 x h, w = 0,5 x D)*				
	G kg/m	H mm	D mm	w mm	A _L m ² /m

HE 450 AA	93,7	646,7	475	118,75	1,856
HE 450 A	132,8	661,7	475	118,75	1,887
HE 450 B	162,7	671,7	475	118,75	1,908
HE 450 M	250,7	699,7	475	118,75	1,996
HE 500 AA	100,5	717,9	525	131,25	1,936
HE 500 A	147,2	735,9	525	131,25	1,973
HE 500 B	177,8	745,9	525	131,25	1,994
HE 500 M	256,4	769,9	525	131,25	2,070
HE 550 AA	111,7	794,5	580	145	2,021
HE 550 A	157,2	812,5	580	145	2,058
HE 550 B	188,6	822,5	580	145	2,079
HE 550 M	263	844,5	580	145	2,150
HE 600 AA	119,4	867,7	630	157,5	2,105
HE 600 A	167,7	886,7	630	157,5	2,144
HE 600 B	199,9	896,7	630	157,5	2,165
HE 600 M	269,1	916,7	630	157,5	2,228
HE 600 x 337	317	928,7	630	157,5	2,274
HE 600 x 399	375,8	944,7	630	157,5	2,328
HE 650 AA	127,4	945,8	690	172,5	2,186
HE 650 A	178,3	965,8	690	172,5	2,227
HE 650 B	211,2	975,8	690	172,5	2,248
HE 650 M	275,6	993,8	690	172,5	2,307
HE 650 x 343	322,3	1005,8	690	172,5	2,349
HE 650 x 407	382,3	1021,8	690	172,5	2,403
HE 700 AA	138,2	1017,6	735	183,75	2,274
HE 700 A	191,5	1037,6	735	183,75	2,314
HE 700 B	225,3	1047,6	735	183,75	2,336
HE 700 M	281,8	1063,6	735	183,75	2,386
HE 700 x 352	329,7	1075,6	735	183,75	2,428
HE 700 x 418	391,1	1091,6	735	183,75	2,482

95,6	621,4	475	237,5	1,901
135,2	629,9	460	230	1,934
165,3	647,1	475	235	1,951
254,3	685,2	500	250	2,031
102,8	690	525	262,5	1,986
149,8	704,5	515	255	2,024
180,9	717,3	525	265	2,042
260,6	751,4	550	280	2,111
114,4	763,9	580	290	2,076
160,3	774,6	565	285	2,115
192,2	791,9	580	290	2,133
267,7	822,5	600	300	2,197
122,5	834,5	630	315	2,165
171,1	849,2	620	310	2,205
203,9	862	630	320	2,224
274,3	890,7	650	330	2,281
323,6	895,5	630	315	2,328
383,5	911,5	630	315	2,381
130,9	909,5	690	345	2,253
182,3	919,3	670	340	2,296
215,8	936,6	685	345	2,314
281,4	961,8	700	350	2,367
329,4	969,5	690	345	2,410
390,7	985,5	690	345	2,462
142,1	979	735	367,5	2,344
196,0	993,9	725	365	2,387
230,4	1009,7	735	365	2,405
288,0	1030	750	380	2,451
337,3	1037	735	367,5	2,494
400,0	1053	735	367,5	2,546

* Ejemplo: posibilidad de otras geometrías.
h = altura del perfil de base

* Example: other geometries are possible.
h = height of base profile.

* Esempio: sono possibili altre geometrie.
h = altezza del profilo di base.

ACB – Vigas alveolares con alvéolos circulares (continúa)

Dimensiones: Las dimensiones de las vigas alveolares son variables. Pueden optimizarse con ayuda del software ACB.

Ejecución de las soldaduras según diseño

Estado de la superficie: conforme a norma EN 10163-3: 2004, clase C, subclase 1

ACB – Castellated beams with circular openings (continued)

Dimensions: The dimensions of the castellated beams are variable. They can be optimised with the ACB software.

Execution of the welds according to design

Surface condition: according to EN 10163-3: 2004, class C, subclass 1

ACB - Travi alveolari con aperture circolari (continua)

Dimensioni: le dimensioni delle Travi alveolari sono variabili. Possono essere ottimizzate con il software ACB.

La esecuzione delle saldature dipende dal disegno

Condizioni di superficie: secondo EN 10163-3: 2004, classe C, sottoclasse 1

HE					
Perfil básico Base profile Profilo di base	Viga de techo / Roof beam / trave per coperture				
	(D ≈ 1,05 x h, w = 0,25 x D)*				
	G kg/m	H mm	D mm	w mm	A _L m ² /m

HE 800 AA	157,3	1168,4	840	210	2,439
HE 800 A	209,1	1188,4	840	210	2,479
HE 800 B	244,6	1198,4	840	210	2,501
HE 800 M	296	1212,4	840	210	2,543
HE 800 x 373	347,2	1224,4	840	210	2,589
HE 800 x 444	413,8	1240,4	840	210	2,643
HE 900 AA	180,9	1321,6	950	237,5	2,608
HE 900 A	233,4	1341,6	950	237,5	2,648
HE 900 B	270,4	1351,6	950	237,5	2,670
HE 900 M	308,6	1361,6	950	237,5	2,699
HE 900 x 391	362,2	1373,6	950	237,5	2,745
HE 900 x 466	431,8	1389,6	950	237,5	2,800
HE 1000 AA	201,5	1470,1	1050	262,5	2,780
HE 1000 A	251,6	1490,1	1050	262,5	2,820
HE 1000 B	290,2	1500,1	1050	262,5	2,842
HE 1000 M	322,4	1508,1	1050	262,5	2,867
HE 1000 x 393	362,1	1516,1	1050	262,5	2,888
HE 1000 x 415	377,8	1520,1	1050	262,5	2,901
HE 1000 x 494	450,7	1536,1	1050	262,5	2,956
HE 1000 x 584	534,7	1556,1	1050	262,5	3,018

HE					
Perfil básico Base profile Profilo di base	Jácena / Floor beam / trave per solaio				
	(D ≈ 1,05 x h, w = 0,5 x D)*				
	G kg/m	H mm	D mm	w mm	A _L m ² /m

HE 800 AA	162,1	1124,5	840	420	2,521
HE 800 A	214,5	1138,6	830	420	2,563
HE 800 B	250,6	1154,5	840	420	2,581
HE 800 M	303,0	1175,7	855	425	2,618
HE 800 x 373	355,8	1180,5	840	420	2,666
HE 800 x 444	424,2	1196,5	840	420	2,718
HE 900 AA	186,8	1272,1	950	475	2,701
HE 900 A	239,8	1286,3	935	465	2,743
HE 900 B	277,7	1299,2	945	475	2,762
HE 900 M	316,7	1315	955	475	2,788
HE 900 x 391	372,0	1324,1	950	475	2,834
HE 900 x 466	443,6	1340,1	950	475	2,886
HE 1000 AA	208,4	1415,4	1050	525	2,883
HE 1000 A	258,8	1435,4	1050	525	2,923
HE 1000 B	298,5	1445,4	1050	525	2,943
HE 1000 M	331,5	1453,4	1050	525	2,967
HE 1000 x 393	372,7	1461,4	1050	525	2,988
HE 1000 x 415	388,7	1465,4	1050	525	3,000
HE 1000 x 494	463,7	1481,4	1050	525	3,052
HE 1000 x 584	549,9	1501,4	1050	525	3,113

* Ejemplo: posibilidad de otras geometrías.
h = altura del perfil de base

* Example: other geometries are possible.
h = height of base profile.

* Esempio: sono possibili altre geometrie.
h = altezza del profilo di base.

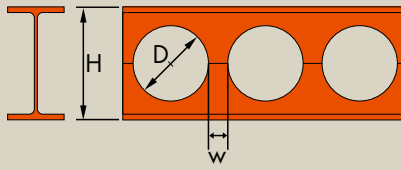

ACB

Páginas de notaciones 199-203 / Notations pages 199-203 / Pagine di annotazioni 199-203

HL					
Perfil básico Base profile Profilo di base	Viga de techo / Roof beam / trave per copertura				
	(D ≈ 1,05 x h, w = 0,25 x D)*				
	G kg/m	H mm	D mm	w mm	A _L m ² /m

HL 920 x 344	320,1	1402,4	999	249,75	3,201
HL 920 x 368	341,2	1406,4	999	249,75	3,214
HL 920 x 390	362,6	1411,4	999	249,75	3,228
HL 920 x 420	392,3	1418,4	999	249,75	3,251
HL 920 x 449	419,8	1423,4	999	249,75	3,266
HL 920 x 491	458,3	1432,4	999	249,75	3,280
HL 920 x 537	501,8	1440,4	999	249,75	3,310
HL 920 x 588	550,4	1451,4	999	249,75	3,341
HL 920 x 656	614,4	1462,4	999	249,75	3,381
HL 920 x 725	678,9	1474,4	999	249,75	3,419
HL 920 x 787	737,7	1486,4	999	249,75	3,456
HL 920 x 970	911,0	1518,4	999	249,75	3,561
HL 1000 AA	275,1	1482,1	1050	262,5	3,204
HL 1000 A	300,3	1490,1	1050	262,5	3,220
HL 1000 B	346,7	1500,1	1050	262,5	3,242
HL 1000 M	385,2	1508,1	1050	262,5	3,267
HL 1000 x 443	412,9	1512,1	1050	262,5	3,276
HL 1000 x 483	451,0	1520,1	1050	262,5	3,301
HL 1000 x 539	503,8	1530,1	1050	262,5	3,334
HL 1000 x 554	517,1	1532,1	1050	262,5	3,343
HL 1000 x 591	552,0	1540,1	1050	262,5	3,364
HL 1000 x 642	599,2	1548,1	1050	262,5	3,393
HL 1000 x 748	699,6	1568,1	1050	262,5	3,456
HL 1000 x 883	826,3	1592,1	1050	262,5	3,535
HL 1100 A	317,9	1640,9	1155	288,75	3,408
HL 1100 B	362,7	1650,9	1155	288,75	3,429
HL 1100 M	402,5	1658,9	1155	288,75	3,454
HL 1100 R	463,0	1668,9	1155	288,75	3,488

HL					
Perfil básico Base profile Profilo di base	Jácena / Floor beam / trave per solaio				
	(D ≈ 1,05 x h, w = 0,5 x D)*				
	G kg/m	H mm	D mm	w mm	A _L m ² /m

HL 920 x 344	328,1	1350,3	999	499,5	3,297
HL 920 x 368	349,6	1354,3	999	499,5	3,309
HL 920 x 390	371,4	1359,3	999	499,5	3,323
HL 920 x 420	401,6	1366,3	999	499,5	3,345
HL 920 x 449	429,7	1371,3	999	499,5	3,360
HL 920 x 491	469,0	1380,3	999	499,5	3,374
HL 920 x 537	513,5	1388,3	999	499,5	3,402
HL 920 x 588	563,2	1399,3	999	499,5	3,432
HL 920 x 656	628,7	1410,3	999	499,5	3,471
HL 920 x 725	694,7	1422,3	999	499,5	3,507
HL 920 x 787	754,6	1434,3	999	499,5	3,543
HL 920 x 970	931,6	1466,3	999	499,5	3,644
HL 1000 AA	282,3	1427,4	1050	525	3,307
HL 1000 A	307,4	1435,4	1050	525	3,323
HL 1000 B	355,0	1445,4	1050	525	3,343
HL 1000 M	394,3	1453,4	1050	525	3,367
HL 1000 x 443	423,1	1457,4	1050	525	3,375
HL 1000 x 483	462,1	1465,4	1050	525	3,400
HL 1000 x 539	516,2	1475,4	1050	525	3,432
HL 1000 x 554	529,9	1477,4	1050	525	3,440
HL 1000 x 591	565,5	1485,4	1050	525	3,460
HL 1000 x 642	614,0	1493,4	1050	525	3,488
HL 1000 x 748	716,5	1513,4	1050	525	3,549
HL 1000 x 883	846,1	1537,4	1050	525	3,625
HL 1100 A	326,5	1580,9	1155	577,5	3,521
HL 1100 B	372,3	1590,9	1155	577,5	3,541
HL 1100 M	413,0	1598,9	1155	577,5	3,566
HL 1100 R	475,4	1608,9	1155	577,5	3,598

* Ejemplo: posibilidad de otras geometrías.
h = altura del perfil de base

* Example: other geometries are possible.
h = height of base profile.

* Esempio: sono possibili altre geometrie.
h = altezza del profilo di base.

Vigas alveolares con alvéolos hexagonales

Dimensiones: Las dimensiones de las vigas alveolares son variables
Ejecución de las soldaduras según diseño
Estado de la superficie: conforme a norma EN 10163-3: 2004, clase C, subclase 1

Castellated beams with hexagonal openings

Dimensions: The dimensions of the castellated beams are variable
Execution of the welds according to design
Surface condition: according to EN 10163-3: 2004, class C, subclass 1

Travi alveolari con aperture esagonali

Dimensioni: le dimensioni delle Travi alveolari sono variabili.
La esecuzione delle saldature dipende dal disegno
Condizioni di superficie: secondo EN 10163-3: 2004, classe C, sottoclasse 1

HE					
Perfil básico Base profile Profilo di base	Vigas alveolares con alvéolos hexagonales Castellated beams with hexagonal openings Travi alveolari con aperture esagonali				
	$(H_t = 1,5 \times h; w = 0,5 \times h)^*$				
	G kg/m	H _t mm	h' mm	w mm	A _L m ² /m

HE 260 AA	54,1	366,0	244,0	122,0	1,474
HE 260 A	68,2	375,0	250,0	125,0	1,484
HE 260 B	93,0	390,0	260,0	130,0	1,499
HE 260 M	172,0	435,0	290,0	145,0	1,575
HE 280 AA	61,2	396,0	264,0	132,0	1,593
HE 280 A	76,4	405,0	270,0	135,0	1,603
HE 280 B	103,0	420,0	280,0	140,0	1,618
HE 280 M	189,0	465,0	310,0	155,0	1,694
HE 300 AA	69,8	425,0	283,0	142,0	1,705
HE 300 A	88,3	435,0	290,0	145,0	1,717
HE 300 B	117,0	450,0	300,0	150,0	1,732
HE 300 M	238,0	510,0	340,0	170,0	1,832
HE 320 AA	74,2	452,0	301,0	151,0	1,740
HE 320 A	97,6	465,0	310,0	155,0	1,756
HE 320 B	127,0	480,0	320,0	160,0	1,771
HE 320 M	245,0	539,0	359,0	180,0	1,866
HE 340 AA	78,9	480,0	320,0	160,0	1,777
HE 340 A	105,0	495,0	330,0	165,0	1,795
HE 340 B	134,0	510,0	340,0	170,0	1,810
HE 340 M	248,0	566,0	377,0	189,0	1,902
HE 360 AA	83,7	509,0	339,0	170,0	1,814
HE 360 A	112,0	525,0	350,0	175,0	1,834
HE 360 B	142,0	540,0	360,0	180,0	1,849
HE 360 M	250,0	593,0	395,0	198,0	1,934
HE 400 AA	92,4	567,0	378,0	189,0	1,891
HE 400 A	125,0	585,0	390,0	195,0	1,912
HE 400 B	155,0	600,0	400,0	200,0	1,927
HE 400 M	256,0	648,0	432,0	216,0	2,004

HE					
Perfil básico Base profile Profilo di base	Vigas alveolares con alvéolos hexagonales Castellated beams with hexagonal openings Travi alveolari con aperture esagonali				
	$(H_t = 1,5 \times h; w = 0,5 \times h)^*$				
	G kg/m	H _t mm	h' mm	w mm	A _L m ² /m

HE 450 AA	99,7	638,0	425,0	213,0	1,984
HE 450 A	140,0	660,0	440,0	220,0	2,011
HE 450 B	171,0	675,0	450,0	225,0	2,026
HE 450 M	263,0	717,0	478,0	239,0	2,096
HE 500 AA	107,0	708,0	472,0	236,0	2,077
HE 500 A	155,0	735,0	490,0	245,0	2,110
HE 500 B	187,0	750,0	500,0	250,0	2,125
HE 500 M	270,0	786,0	524,0	262,0	2,184
HE 550 AA	120,0	783,0	522,0	261,0	2,175
HE 550 A	166,0	810,0	540,0	270,0	2,209
HE 550 B	199,0	825,0	550,0	275,0	2,224
HE 550 M	278,0	858,0	572,0	286,0	2,280
HE 600 AA	129,0	856,5	571,0	285,5	2,272
HE 600 A	178,0	885,0	590,0	295,0	2,308
HE 600 B	212,0	900,0	600,0	300,0	2,323
HE 600 M	285,0	930,0	620,0	310,0	2,372
HE 600 x 337	337,0	948,0	632,0	316,0	2,407
HE 600 x 399	399,0	972,0	648,0	324,0	2,450
HE 650 AA	138,0	930,0	620,0	310,0	2,369
HE 650 A	190,0	960,0	640,0	320,0	2,407
HE 650 B	225,0	975,0	650,0	325,0	2,422
HE 650 M	293,0	1002,0	668,0	334,0	2,468
HE 650 x 343	343,0	1020,0	680,0	340,0	2,500
HE 650 x 407	407,0	1044,0	696,0	348,0	2,543
HE 700 AA	150,0	1005,0	670,0	335,0	2,468
HE 700 A	204,0	1035,0	690,0	345,0	2,505
HE 700 B	241,0	1050,0	700,0	350,0	2,520
HE 700 M	301,0	1074,0	716,0	358,0	2,560
HE 700 x 352	352,0	1092,0	728,0	364,0	2,592
HE 700 x 418	418,0	1116,0	744,0	372,0	2,635

* Ejemplo: posibilidad de otras geometrías.
h = altura del perfil de base.

* Example: other geometries are possible.
h = height of base profile.

* Esempio: sono possibili altre geometrie.
h = altezza del profilo di base.

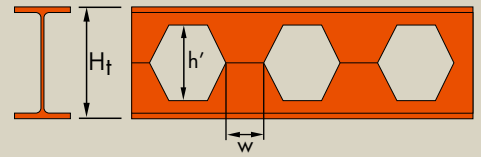

Páginas de notaciones 199-203 / Notations pages 199-203 / Pagine di annotazioni 199-203

HE					
Perfil básico Base profile Profilo di base	Vigas alveolares con alvéolos hexagonales Castellated beams with hexagonal openings Travi alveolari con aperture esagonali				
	$(H_t = 1,5 \times h; w = 0,5 \times h)^*$				
	G kg/m	H _t mm	h' mm	w mm	A _L m ² /m

HE 800 AA	172,0	1155,0	770,0	385,0	2,660
HE 800 A	224,0	1185,0	790,0	395,0	2,698
HE 800 B	262,0	1200,0	800,0	400,0	2,713
HE 800 M	317,0	1221,0	814,0	407,0	2,746
HE 800 x 373	373,0	1239,0	826,0	413,0	2,782
HE 800 x 444	444,0	1263,0	842,0	421,0	2,824
HE 900 AA	198,0	1305,0	870,0	435,0	2,858
HE 900 A	252,0	1335,0	890,0	445,0	2,896
HE 900 B	291,0	1350,0	900,0	450,0	2,911
HE 900 M	333,0	1365,0	910,0	455,0	2,934
HE 900 x 391	391,0	1383,0	922,0	461,0	2,970
HE 900 x 466	466,0	1407,0	938,0	469,0	3,012
HE 1000 AA	222,0	1455,0	970,0	485,0	3,056
HE 1000 A	272,0	1485,0	990,0	495,0	3,095
HE 1000 B	314,0	1500,0	1000,0	500,0	3,110
HE 1000 M	349,0	1512,0	1008,0	504,0	3,130
HE 1000 x 393	393,0	1524,0	1016,0	508,0	3,144
HE 1000 x 409	409,0	1530,0	1020,0	510,0	3,162
HE 1000 x 488	488,0	1554,0	1036,0	518,0	3,204
HE 1000 x 579	579,0	1584,0	1056,0	528,0	3,254

HL					
Perfil básico Base profile Profilo di base	Vigas alveolares con alvéolos hexagonales Castellated beams with hexagonal openings Travi alveolari con aperture esagonali				
	$(H_t = 1,5 \times h; w = 0,5 \times h)^*$				
	G kg/m	H _t mm	h' mm	w mm	A _L m ² /m

HL 920 x 344	345,0	1390,5	927,0	463,5	3,450
HL 920 x 368	368,0	1396,5	931,0	465,5	3,460
HL 920 x 390	390,0	1404,0	936,0	468,0	3,480
HL 920 x 420	420,0	1414,5	943,0	471,5	3,500
HL 920 x 449	449,0	1422,0	948,0	474,0	3,510
HL 920 x 491	491,0	1435,5	957,0	478,5	3,520
HL 920 x 537	537,0	1447,5	965,0	482,5	3,540
HL 920 x 588	588,0	1464,0	976,0	488,0	3,570
HL 920 x 656	656,0	1480,5	987,0	493,5	3,600
HL 920 x 725	725,0	1498,5	999,0	499,5	3,630
HL 920 x 787	787,0	1516,5	1011,0	505,5	3,660
HL 920 x 970	970,0	1564,5	1043,0	521,5	3,740
HL 1000 AA	296,0	1473,0	982,0	491,0	3,479
HL 1000 A	321,0	1485,0	990,0	495,0	3,495
HL 1000 B	371,0	1500,0	1000,0	500,0	3,510
HL 1000 M	412,0	1512,0	1008,0	504,0	3,530
HL 1000 x 443	443,0	1518,0	1012,0	506,0	3,530
HL 1000 x 483	483,0	1530,0	1020,0	510,0	3,550
HL 1000 x 539	539,0	1545,0	1030,0	515,0	3,580
HL 1000 x 554	554,0	1548,0	1032,0	516,0	3,590
HL 1000 x 591	591,0	1560,0	1040,0	520,0	3,600
HL 1000 x 642	642,0	1572,0	1048,0	524,0	3,620
HL 1000 x 748	748,0	1602,0	1068,0	534,0	3,670
HL 1000 x 883	883,0	1638,0	1092,0	546,0	3,740
HL 1100 A	343,0	1635,0	1090,0	545,0	3,710
HL 1100 B	390,0	1650,0	1100,0	550,0	3,726
HL 1100 M	433,0	1662,0	1108,0	554,0	3,746
HL 1100 R	499,0	1677,0	1118,0	559,0	3,770

* Ejemplo: posibilidad de otras geometrías.
h = altura del perfil de base.

* Example: other geometries are possible.
h = height of base profile.

* Esempio: sono possibili altre geometrie.
h = altezza del profilo di base.

Vigas alveolares con alvéolos hexagonales (continúa)

Dimensiones: Las dimensiones de las vigas alveolares son variables
Ejecución de las soldaduras según diseño
Estado de la superficie: conforme a norma EN 10163-3: 2004, clase C, subclase 1

Castellated beams with hexagonal openings (continued)

Dimensions: The dimensions of the castellated beams are variable
Execution of the welds according to design
Surface condition: according to EN 10163-3: 2004, class C, subclass 1

Travi alveolari con aperture esagonali (continua)

Dimensioni: le dimensioni delle Travi alveolari sono variabili.
La esecuzione delle saldature dipende dal disegno
Condizioni di superficie: secondo EN 10163-3: 2004, classe C, sottoclasse 1

IPE					
Perfil básico Base profile Profilo di base	Vigas alveolares con alvéolos hexagonales Castellated beams with hexagonal openings Travi alveolari con aperture esagonali				
	$(H_t = 1,5 \times h; w = 0,5 \times h)^*$				
	G kg/m	H _t mm	h' mm	w mm	A _L m ² /m

IPE A 200	18,4	295,5	197,0	98,5	0,764
IPE 200	22,4	300,0	200,0	100,0	0,768
IPE O 200	25,1	303,0	202,0	101,0	0,779
IPE A 220	22,2	325,5	217,0	108,5	0,843
IPE 220	26,2	330,0	220,0	110,0	0,848
IPE O 220	29,4	333,0	222,0	111,0	0,858
IPE A 240	26,2	355,5	237,0	118,5	0,918
IPE 240	30,7	360,0	240,0	120,0	0,922
IPE O 240	34,3	363,0	242,0	121,0	0,932
IPE A 270	30,7	400,5	267,0	133,5	1,037
IPE 270	36,1	405,0	270,0	135,0	1,041
IPE O 270	42,3	411,0	274,0	137,0	1,051
IPE A 300	36,5	445,5	297,0	148,5	1,156
IPE 300	42,2	450,0	300,0	150,0	1,160
IPE O 300	49,3	456,0	304,0	152,0	1,174
IPE A 330	43,0	490,5	327,0	163,5	1,250
IPE 330	49,1	495,0	330,0	165,0	1,254
IPE O 330	57,0	501,0	334,0	167,0	1,268
IPE A 360	50,2	536,4	358,0	178,8	1,351
IPE 360	57,1	540,0	360,0	180,0	1,353
IPE O 360	66,0	546,0	364,0	182,0	1,367

IPE					
Perfil básico Base profile Profilo di base	Vigas alveolares con alvéolos hexagonales Castellated beams with hexagonal openings Travi alveolari con aperture esagonali				
	$(H_t = 1,5 \times h; w = 0,5 \times h)^*$				
	G kg/m	H _t mm	h' mm	w mm	A _L m ² /m

IPE A 400	57,4	595,5	397,0	198,5	1,464
IPE 400	66,3	600,0	400,0	200,0	1,467
IPE O 400	75,7	606,0	404,0	202,0	1,481
IPE A 450	67,2	670,5	447,0	223,5	1,603
IPE 450	77,6	675,0	450,0	225,0	1,605
IPE O 450	92,4	684,0	456,0	228,0	1,622
IPE A 500	79,4	745,5	497,0	248,5	1,741
IPE 500	90,7	750,0	500,0	250,0	1,744
IPE O 500	107,0	759,0	506,0	253,0	1,760
IPE A 550	92,1	820,5	547,0	273,5	1,875
IPE 550	106,0	825,0	550,0	275,0	1,877
IPE O 550	123,0	834,0	556,0	278,0	1,893
IPE A 600	108,0	895,5	597,0	298,5	2,013
IPE 600	122,0	900,0	600,0	300,0	2,015
IPE O 600	154,0	915,0	610,0	305,0	2,045
IPE 750 x 147	147,0	1129,5	753,0	376,5	2,510
IPE 750 x 173	173,0	1143,0	762,0	381,0	2,534
IPE 750 x 196	196,0	1155,0	770,0	385,0	2,552

* Ejemplo: posibilidad de otras geometrías.
h = altura del perfil de base.

* Example: other geometries are possible.
h = height of base profile.

* Esempio: sono possibili altre geometrie.
h = altezza del profilo di base.

Vigas alveolares con alvéolos octogonales

Dimensiones: Las dimensiones de las vigas alveolares son variables
Ejecución de las soldaduras según diseño
Estado de la superficie: conforme a norma EN 10163-3: 2004, clase C, subclase 1

Castellated beams with octagonal openings

Dimensions: The dimensions of the castellated beams are variable
Execution of the welds according to design
Surface condition: according to EN 10163-3: 2004, class C, subclass 1

Travi alveolari con aperture ottagonali

Dimensioni: le dimensioni delle Travi alveolari sono variabili.
La esecuzione delle saldature dipende dal disegno
Condizioni di superficie: secondo EN 10163-3: 2004, classe C, sottoclasse 1

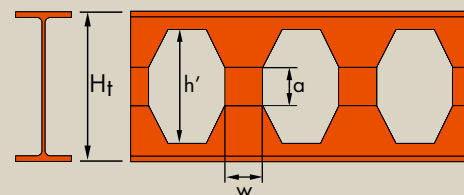

Páginas de notaciones 199-203 / Notations pages 199-203 / Pagine di annotazioni 199-203

Perfil básico Base profile Profilo di base	HE					
	Vigas alveolares con alvéolos octogonales Castellated beams with octagonal openings Travi alveolari con aperture ottagonali					
	$(H_t = 1,5 \times h; w = 0,5 \times h)^*$					
	a mm	G kg/m	H _t mm	h' mm	w mm	A _L m ² /m

HE 260 AA	122,0	56,2	488,0	366,0	122,0	1,515
HE 260 A	125,0	71,0	500,0	375,0	125,0	1,526
HE 260 B	130,0	96,4	520,0	390,0	130,0	1,542
HE 260 M	145,0	179,0	580,0	435,0	145,0	1,623
HE 280 AA	132,0	63,6	528,0	396,0	132,0	1,637
HE 280 A	135,0	79,2	540,0	405,0	135,0	1,648
HE 280 B	140,0	107,0	560,0	420,0	140,0	1,665
HE 280 M	155,0	197,0	620,0	465,0	155,0	1,746
HE 300 AA	141,5	72,6	566,0	425,0	142,0	1,752
HE 300 A	145,0	91,5	580,0	435,0	145,0	1,765
HE 300 B	150,0	121,3	600,0	450,0	150,0	1,782
HE 300 M	170,0	247,0	680,0	510,0	170,0	1,889
HE 320 AA	150,5	77,4	602,0	452,0	151,0	1,790
HE 320 A	155,0	101,0	620,0	465,0	155,0	1,808
HE 320 B	160,0	132,0	640,0	480,0	160,0	1,824
HE 320 M	179,5	255,0	718,0	539,0	180,0	1,926
HE 340 AA	160,0	82,5	640,0	480,0	160,0	1,830
HE 340 A	165,0	109,0	660,0	495,0	165,0	1,850
HE 340 B	170,0	139,0	680,0	510,0	170,0	1,867
HE 340 M	188,5	258,0	754,0	566,0	189,0	1,965
HE 360 AA	169,5	87,7	678,0	509,0	170,0	1,871
HE 360 A	175,0	117,0	700,0	525,0	175,0	1,892
HE 360 B	180,0	148,0	720,0	540,0	180,0	1,909
HE 360 M	197,5	261,0	790,0	593,0	198,0	2,000
HE 400 AA	189,0	97,1	756,0	567,0	189,0	1,954
HE 400 A	195,0	131,0	780,0	585,0	195,0	1,977
HE 400 B	200,0	162,0	800,0	600,0	200,0	1,994
HE 400 M	216,0	268,0	864,0	648,0	216,0	2,076

Perfil básico Base profile Profilo di base	HE					
	Vigas alveolares con alvéolos octogonales Castellated beams with octagonal openings Travi alveolari con aperture ottagonali					
	$(H_t = 1,5 \times h; w = 0,5 \times h)^*$					
	a mm	G kg/m	H _t mm	h' mm	w mm	A _L m ² /m

HE 450 AA	212,5	105,0	850,0	638,0	213,0	2,055
HE 450 A	220,0	147,0	880,0	660,0	220,0	2,084
HE 450 B	225,0	179,0	900,0	675,0	225,0	2,101
HE 450 M	239,0	276,0	956,0	717,0	239,0	2,176
HE 500 AA	236,0	113,0	944,0	708,0	236,0	2,156
HE 500 A	245,0	163,0	980,0	735,0	245,0	2,192
HE 500 B	250,0	196,0	1000,0	750,0	250,0	2,208
HE 500 M	262,0	284,0	1048,0	786,0	262,0	2,271
HE 550 AA	261,0	128,0	1044,0	783,0	261,0	2,262
HE 550 A	270,0	175,0	1080,0	810,0	270,0	2,299
HE 550 B	275,0	210,0	1100,0	825,0	275,0	2,316
HE 550 M	286,0	294,0	1144,0	858,0	286,0	2,375
HE 600 AA	285,5	138,0	1142,0	856,5	285,5	2,367
HE 600 A	295,0	188,0	1180,0	885,0	295,0	2,406
HE 600 B	300,0	224,0	1200,0	900,0	300,0	2,423
HE 600 M	310,0	302,0	1240,0	930,0	310,0	2,475
HE 600 x 337	316,0	358,0	1264,0	948,0	316,0	2,512
HE 600 x 399	324,0	424,0	1296,0	972,0	324,0	2,558
HE 650 AA	310,0	148,0	1240,0	930,0	310,0	2,472
HE 650 A	320,0	201,0	1280,0	960,0	320,0	2,514
HE 650 B	325,0	239,0	1300,0	975,0	325,0	2,530
HE 650 M	334,0	311,0	1336,0	1002,0	334,0	2,579
HE 650 x 343	340,0	365,0	1360,0	1020,0	340,0	2,613
HE 650 x 407	348,0	434,0	1392,0	1044,0	348,0	2,659
HE 700 AA	335,0	161,0	1340,0	1005,0	335,0	2,580
HE 700 A	345,0	217,0	1380,0	1035,0	345,0	2,620
HE 700 B	350,0	257,0	1400,0	1050,0	350,0	2,637
HE 700 M	358,0	321,0	1432,0	1074,0	358,0	2,679
HE 700 x 352	364,0	376,0	1456,0	1092,0	364,0	2,713
HE 700 x 418	372,0	447,0	1488,0	1116,0	372,0	2,759

* Ejemplo: posibilidad de otras geometrías.
h = altura del perfil de base.

* Example: other geometries are possible.
h = height of base profile.

* Esempio: sono possibili altre geometrie..
h = altezza del profilo di base.

Vigas alveolares con alvéolos octogonales (continúa)

Dimensiones: Las dimensiones de las vigas alveolares son variables
Ejecución de las soldaduras según diseño
Estado de la superficie: conforme a norma EN 10163-3: 2004, clase C, subclase 1

Castellated beams with octagonal openings (continued)

Dimensions: The dimensions of the castellated beams are variable
Execution of the welds according to design
Surface condition: according to EN 10163-3: 2004, class C, subclass 1

Travi alveolari con aperture ottagonali (continua)

Dimensioni: le dimensioni delle Travi alveolari sono variabili.
La esecuzione delle saldature dipende dal disegno
Condizioni di superficie: secondo EN 10163-3: 2004, classe C, sottoclasse 1

HE						
Perfil básico Base profile Profilo di base	Vigas alveolares con alvéolos octogonales Castellated beams with octagonal openings Travi alveolari con aperture ottagonali					
	(H _t = 1,5 x h; w = 0,5 x h)*					
	a	G	H _t	h'	w	A _L
	mm	kg/m	mm	mm	mm	m ² /m

HE 800 AA	385,0	186,0	1540,0	1155,0	385,0	2,788
HE 800 A	395,0	240,0	1580,0	1185,0	395,0	2,830
HE 800 B	400,0	280,0	1600,0	1200,0	400,0	2,846
HE 800 M	407,0	339,0	1628,0	1221,0	407,0	2,882
HE 800 x 373	413,0	400,0	1652,0	1239,0	413,0	2,920
HE 800 x 444	421,0	477,0	1684,0	1263,0	421,0	2,964
HE 900 AA	435,0	215,0	1740,0	1305,0	435,0	3,003
HE 900 A	445,0	271,0	1780,0	1335,0	445,0	3,044
HE 900 B	450,0	313,0	1800,0	1350,0	450,0	3,061
HE 900 M	455,0	358,0	1820,0	1365,0	455,0	3,086
HE 900 x 391	461,0	421,0	1844,0	1383,0	461,0	3,124
HE 900 x 466	469,0	503,0	1876,0	1407,0	469,0	3,168
HE 1000 AA	485,0	242,0	1940,0	1455,0	485,0	3,218
HE 1000 A	495,0	293,0	1980,0	1485,0	495,0	3,260
HE 1000 B	500,0	339,0	2000,0	1500,0	500,0	3,277
HE 1000 M	504,0	377,0	2016,0	1512,0	504,0	3,298
HE 1000 x 393	508,0	425,0	2032,0	1524,0	508,0	3,313
HE 1000 x 409	510,0	442,0	2040,0	1530,0	510,0	3,332
HE 1000 x 488	518,0	529,0	2072,0	1554,0	518,0	3,377
HE 1000 x 579	528,0	627,0	2112,0	1584,0	528,0	3,430

HL						
Perfil básico Base profile Profilo di base	Vigas alveolares con alvéolos octogonales Castellated beams with octagonal openings Travi alveolari con aperture ottagonali					
	(H _t = 1,5 x h; w = 0,5 x h)*					
	a	G	H _t	h'	w	A _L
	mm	kg/m	mm	mm	mm	m ² /m

HL 920 x 344	463,5	368,0	1854,0	1390,5	463,5	3,605
HL 920 x 368	465,5	393,0	1862,0	1396,5	465,5	3,615
HL 920 x 390	468,0	416,0	1872,0	1404,0	468,0	3,636
HL 920 x 420	471,5	448,0	1886,0	1414,5	471,5	3,657
HL 920 x 449	474,0	479,0	1896,0	1422,0	474,0	3,668
HL 920 x 491	478,5	523,0	1914,0	1435,5	478,5	3,680
HL 920 x 537	482,5	573,0	1930,0	1447,5	482,5	3,701
HL 920 x 588	488,0	628,0	1952,0	1464,0	488,0	3,733
HL 920 x 656	493,5	701,0	1974,0	1480,5	493,5	3,765
HL 920 x 725	499,5	775,0	1998,0	1498,5	499,5	3,797
HL 920 x 787	505,5	841,0	2022,0	1516,5	505,5	3,829
HL 920 x 970	521,5	1038,0	2086,0	1564,5	521,5	3,914
HL 1000 AA	491,0	317,0	1964,0	1473,0	491,0	3,643
HL 1000 A	495,0	342,0	1980,0	1485,0	495,0	3,660
HL 1000 B	500,0	396,0	2000,0	1500,0	500,0	3,677
HL 1000 M	504,0	440,0	2016,0	1512,0	504,0	3,698
HL 1000 x 443	506,0	474,0	2024,0	1518,0	506,0	3,699
HL 1000 x 483	510,0	517,0	2040,0	1530,0	510,0	3,720
HL 1000 x 539	515,0	577,0	2060,0	1545,0	515,0	3,752
HL 1000 x 554	516,0	594,0	2064,0	1548,0	516,0	3,762
HL 1000 x 591	520,0	633,0	2080,0	1560,0	520,0	3,773
HL 1000 x 642	524,0	689,0	2096,0	1572,0	524,0	3,795
HL 1000 x 748	534,0	802,0	2136,0	1602,0	534,0	3,848
HL 1000 x 883	546,0	948,0	2184,0	1638,0	546,0	3,922
HL 1100 A	545,0	369,0	2180,0	1635,0	545,0	3,892
HL 1100 B	550,0	419,0	2200,0	1650,0	550,0	3,909
HL 1100 M	554,0	465,0	2216,0	1662,0	554,0	3,931
HL 1100 R	559,0	537,0	2236,0	1677,0	559,0	3,956

* Ejemplo: posibilidad de otras geometrías.
h = altura del perfil de base.

* Example: other geometries are possible.
h = height of base profile.

* Esempio: sono possibili altre geometrie..
h = altezza del profilo di base.

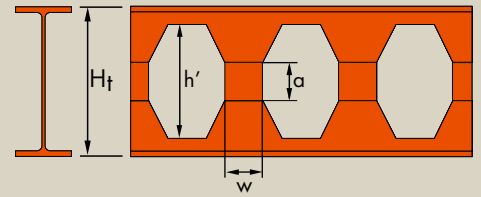

Páginas de notaciones 199-203 / Notations pages 199-203 / Pagine di annotazioni 199-203

IPE						
Perfil básico Base profile Profilo di base	Vigas alveolares con alvéolos octogonales Castellated beams with octagonal openings Travi alveolari con aperture ottagonali					
	(H _t = 1,5 x h; w = 0,5 x h)*					
	a mm	G kg/m	H _t mm	h' mm	w mm	A _L m ² /m
IPE A 200	98,5	19,6	394,0	295,5	98,5	0,797
IPE 200	100,0	23,9	400,0	300,0	100,0	0,801
IPE O 200	101,0	26,7	404,0	303,0	101,0	0,813
IPE A 220	108,5	23,6	434,0	325,5	108,5	0,879
IPE 220	110,0	27,9	440,0	330,0	110,0	0,885
IPE O 220	111,0	31,3	444,0	333,0	111,0	0,895
IPE A 240	118,5	27,8	474,0	355,5	118,5	0,958
IPE 240	120,0	32,6	480,0	360,0	120,0	0,962
IPE O 240	121,0	36,5	484,0	363,0	121,0	0,972
IPE A 270	133,5	32,6	534,0	400,5	133,5	1,082
IPE 270	135,0	38,4	540,0	405,0	135,0	1,086
IPE O 270	137,0	45,0	548,0	411,0	137,0	1,097
IPE A 300	148,5	38,9	594,0	445,5	148,5	1,206
IPE 300	150,0	45,0	600,0	450,0	150,0	1,210
IPE O 300	152,0	52,5	608,0	456,0	152,0	1,225
IPE A 330	163,5	45,8	654,0	490,5	163,5	1,305
IPE 330	165,0	52,3	660,0	495,0	165,0	1,309
IPE O 330	167,0	60,7	668,0	501,0	167,0	1,324
IPE A 360	178,8	53,3	715,0	536,4	178,8	1,411
IPE 360	180,0	60,9	720,0	540,0	180,0	1,413
IPE O 360	182,0	70,4	728,0	546,0	182,0	1,428

IPE						
Perfil básico Base profile Profilo di base	Vigas alveolares con alvéolos octogonales Castellated beams with octagonal openings Travi alveolari con aperture ottagonali					
	(H _t = 1,5 x h; w = 0,5 x h)*					
	a mm	G kg/m	H _t mm	h' mm	w mm	A _L m ² /m
IPE A 400	198,5	61,0	794,0	595,5	198,5	1,530
IPE 400	200,0	70,8	800,0	600,0	200,0	1,534
IPE O 400	202,0	80,8	808,0	606,0	202,0	1,548
IPE A 450	223,5	71,6	894,0	670,5	223,5	1,678
IPE 450	225,0	83,1	900,0	675,0	225,0	1,680
IPE O 450	228,0	99,0	912,0	684,0	228,0	1,698
IPE A 500	248,5	84,9	994,0	745,5	248,5	1,824
IPE 500	250,0	97,4	1000,0	750,0	250,0	1,827
IPE O 500	253,0	115,0	1012,0	759,0	253,0	1,844
IPE A 550	273,5	98,5	1094,0	820,5	273,5	1,966
IPE 550	275,0	114,0	1100,0	825,0	275,0	1,969
IPE O 550	278,0	132,0	1112,0	834,0	278,0	1,986
IPE A 600	298,5	116,0	1194,0	895,5	298,5	2,113
IPE 600	300,0	131,0	1200,0	900,0	300,0	2,115
IPE O 600	305,0	166,0	1220,0	915,0	305,0	2,147
IPE 750 x 147	376,5	160,0	1506,0	1129,5	376,5	2,636
IPE 750 x 173	381,0	187,0	1524,0	1143,0	381,0	2,661
IPE 750 x 196	385,0	212,0	1540,0	1155,0	385,0	2,680

* Ejemplo: posibilidad de otras geometrías.
h = altura del perfil de base.

* Example: other geometries are possible.
h = height of base profile.

* Esempio: sono possibili altre geometrie..
h = altezza del profilo di base.

ACB – Vigas alveolares con alvéolos sinusoidales “ANGELINA®”

Dimensiones: Las dimensiones de las vigas alveolares son variables.
Ejecución de las soldaduras según diseño.
Estado de la superficie: conforme a norma EN 10163-3: 2004, clase C, subclase 1

ACB – Castellated beams with sinusoidal openings “ANGELINA®”

Dimensions: The dimensions of the castellated beams are variable.
Execution of the welds according to design.
Surface condition: according to EN 10163-3: 2004, class C, subclass 1

ACB - Travi alveolari con aperture sinusoidali “ANGELINA®”

Dimensioni: le dimensioni delle Travi alveolari sono variabili.
La esecuzione delle saldature dipende dal disegno
Condizioni di superficie: Secondo EN 10163-3: 2004, classe C, sottoclasse 1

Perfil básico Base Profiles Profilo di base	IPE					
	Jácena / Floor beam / Travi per solai					
	$y = \left(0,5 \cdot \frac{a}{2}\right) \cdot \sin \left[\pi \cdot \left(\frac{x}{b} + \frac{3}{2}\right)\right] + \frac{a}{4}$					
G	H _t	a	b	w	A _L	
kg/m	mm	mm	mm	mm	m ² /m	

IPE A 200	18,4	316,0	238,0	429,5	250	0,764
IPE 200	22,4	319,0	238,0	433,6	250	0,768
IPE O 200	25,1	321,0	238,0	436,3	250	0,779
IPE A 220	22,2	354,6	275,2	482,0	250	0,843
IPE 220	26,2	357,6	275,2	486,1	250	0,848
IPE O 220	29,4	359,6	275,2	488,8	250	0,858
IPE A 240	26,2	387,4	300,8	526,6	250	0,918
IPE 240	30,7	390,4	300,8	530,6	250	0,922
IPE O 240	34,3	392,4	300,8	533,4	250	0,932
IPE A 270	30,7	446,6	359,2	607,0	250	1,037
IPE 270	36,1	449,6	359,2	611,1	250	1,041
IPE O 270	42,3	453,6	359,2	616,5	250	1,051
IPE A 300	36,5	505,6	417,2	687,2	250	1,156
IPE 300	42,2	508,6	417,2	691,3	250	1,160
IPE O 300	49,3	512,6	417,2	696,7	250	1,174
IPE A 330	43,0	558,0	462,0	758,4	250	1,250
IPE 330	49,1	561,0	462,0	762,5	250	1,254
IPE O 330	57,0	565,0	462,0	768,0	250	1,268
IPE A 360	50,2	616,2	517,2	837,6	250	1,351
IPE 360	57,1	618,6	517,2	840,8	250	1,353
IPE O 360	66,0	622,6	517,2	846,3	250	1,367

Perfil básico Base Profiles Profilo di base	IPE					
	Jácena / Floor beam / Travi per solai					
	$y = \left(0,5 \cdot \frac{a}{2}\right) \cdot \sin \left[\pi \cdot \left(\frac{x}{b} + \frac{3}{2}\right)\right] + \frac{a}{4}$					
G	H _t	a	b	w	A _L	
kg/m	mm	mm	mm	mm	m ² /m	

IPE A 400	57,4	688,0	582,0	935,1	250	1,464
IPE 400	66,3	691,0	582,0	939,2	250	1,467
IPE O 400	75,7	695,0	582,0	944,7	250	1,481
IPE A 450	67,2	785,8	677,6	1068,1	250	1,603
IPE 450	77,6	788,8	677,6	1072,2	250	1,605
IPE O 450	92,4	794,8	677,6	1080,3	250	1,622
IPE A 500	79,4	883,0	772,0	1200,2	250	1,741
IPE 500	90,7	886,0	772,0	1204,3	250	1,744
IPE O 500	107,0	892,0	772,0	1212,4	250	1,760
IPE A 550	92,1	974,6	855,2	1324,7	250	1,875
IPE 550	90,7	886,0	772,0	1204,3	250	1,744
IPE O 550	123,0	983,6	855,2	1336,9	250	1,893
IPE A 600	108,0	1071,0	948,0	1455,7	250	2,013
IPE 600	122,0	1074,0	948,0	1459,8	250	2,015
IPE O 600	154,0	1084,0	948,0	1473,4	250	2,045
IPE 750 x 147	147,0	1398,0	1290,0	1900,2	250	2,510
IPE 750 x 173	173,0	1406,8	1289,6	1912,2	250	2,534
IPE 750 x 196	196,0	1415,2	1290,4	1923,6	250	2,552

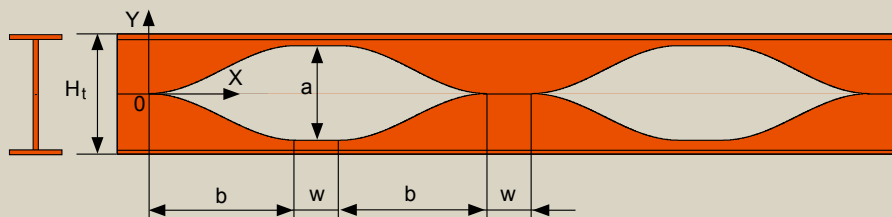

Páginas de notaciones 199-203 / Notations pages 199-203 / Pagine di annotazioni 199-203

Perfil básico Base Profiles Profilo di base	HE					
	Jácena / Floor beam / Travi per solai					
	$y = \left(0,5 \cdot \frac{a}{2}\right) \cdot \sin \left[\pi \cdot \left(\frac{x}{b} + \frac{3}{2}\right)\right] + \frac{a}{4}$					
G	H _t	a	b	w	A _L	
kg/m	mm	mm	mm	mm	m ² /m	

HE 260 AA	54,1	381,0	274,0	517,9	250	1,474
HE 260 A	68,2	387,0	274,0	526,0	250	1,484
HE 260 B	93,0	397,0	274,0	539,6	250	1,499
HE 260 M	172,0	427,0	274,0	580,4	250	1,575
HE 280 AA	61,2	420,0	312,0	570,9	250	1,593
HE 280 A	76,4	426,0	312,0	579,0	250	1,603
HE 280 B	103,0	436,0	312,0	592,6	250	1,618
HE 280 M	189,0	466,0	312,0	633,4	250	1,694
HE 300 AA	69,8	451,0	336,0	613,0	250	1,705
HE 300 A	88,3	458,0	336,0	622,5	250	1,717
HE 300 B	117,0	468,0	336,0	636,1	250	1,732
HE 300 M	238,0	508,0	336,0	690,5	250	1,832
HE 320 AA	74,2	486,0	370,0	660,6	250	1,740
HE 320 A	97,6	495,0	370,0	672,8	250	1,756
HE 320 B	127,0	505,0	370,0	686,4	250	1,771
HE 320 M	245,0	544,0	370,0	739,4	250	1,866
HE 340 AA	78,9	523,0	406,0	710,9	250	1,777
HE 340 A	105,0	533,0	406,0	724,5	250	1,795
HE 340 B	134,0	543,0	406,0	738,1	250	1,810
HE 340 M	248,0	580,0	406,0	788,3	250	1,902
HE 360 AA	83,7	560,0	442,0	761,2	250	1,814
HE 360 A	112,0	571,0	442,0	776,1	250	1,834
HE 360 B	142,0	581,0	442,0	789,7	250	1,849
HE 360 M	250,0	616,0	442,0	837,3	250	1,934
HE 400 AA	92,4	636,0	516,0	864,5	250	1,891
HE 400 A	125,0	648,0	516,0	880,8	250	1,912
HE 400 B	155,0	658,0	516,0	894,4	250	1,927
HE 400 M	256,0	690,0	516,0	937,9	250	2,004
HE 450 AA	99,7	729,0	608,0	990,9	250	1,984
HE 450 A	140,0	744,0	608,0	1011,3	250	2,011
HE 450 B	171,0	754,0	608,0	1024,9	250	2,026
HE 450 M	263,0	782,0	608,0	1062,9	250	2,096

Perfil básico Base Profiles Profilo di base	HE					
	Jácena / Floor beam / Travi per solai					
	$y = \left(0,5 \cdot \frac{a}{2}\right) \cdot \sin \left[\pi \cdot \left(\frac{x}{b} + \frac{3}{2}\right)\right] + \frac{a}{4}$					
G	H _t	a	b	w	A _L	
kg/m	mm	mm	mm	mm	m ² /m	

HE 500 AA	107,0	822,0	700,0	1117,3	250	2,077
HE 500 A	155,0	840,0	700,0	1141,7	250	2,110
HE 500 B	187,0	850,0	700,0	1155,3	250	2,125
HE 500 M	270,0	874,0	700,0	1188,0	250	2,184
HE 550 AA	120,0	920,0	796,0	1250,5	250	2,175
HE 550 A	166,0	938,0	796,0	1275,0	250	2,209
HE 550 B	199,0	948,0	796,0	1288,5	250	2,224
HE 550 M	278,0	970,0	796,0	1318,4	250	2,280
HE 600 AA	129,0	1017,0	892,0	1382,3	250	2,272
HE 600 A	178,0	1036,0	892,0	1408,2	250	2,308
HE 600 B	212,0	1046,0	892,0	1421,7	250	2,323
HE 600 M	285,0	1066,0	892,0	1448,9	250	2,372
HE 600 x 337	337,0	1078,0	892,0	1465,2	250	2,407
HE 600 x 399	399,0	1094,0	892,0	1487,0	250	2,450
HE 650 AA	138,0	1114,0	988,0	1514,2	250	2,369
HE 650 A	190,0	1134,0	988,0	1541,4	250	2,407
HE 650 B	225,0	1144,0	988,0	1555,0	250	2,422
HE 650 M	293,0	1162,0	988,0	1579,4	250	2,468
HE 650 x 343	343,0	1174,0	988,0	1595,7	250	2,500
HE 650 x 407	407,0	1190,0	988,0	1617,5	250	2,543
HE 700 AA	150,0	1212,0	1084,0	1647,4	250	2,468
HE 700 A	204,0	1232,0	1084,0	1674,6	250	2,505
HE 700 B	241,0	1242,0	1084,0	1688,2	250	2,520
HE 700 M	301,0	1258,0	1084,0	1709,9	250	2,560
HE 700 x 352	352,0	1270,0	1084,0	1726,2	250	2,592
HE 700 x 418	418,0	1286,0	1084,0	1748,0	250	2,635
HE 800 AA	172,0	1404,0	1268,0	1908,3	250	2,660
HE 800 A	224,0	1424,0	1268,0	1935,5	250	2,698
HE 800 B	262,0	1434,0	1268,0	1949,1	250	2,713
HE 800 M	317,0	1448,0	1268,0	1968,2	250	2,746
HE 800 x 373	373,0	1460,0	1268,0	1984,5	250	2,782
HE 800 x 444	444,0	1476,0	1268,0	2006,2	250	2,824

ACB – Vigas alveolares con alvéolos sinusoidales “ANGELINA®” (continúa)

Dimensiones: Las dimensiones de las vigas alveolares son variables.

Ejecución de las soldaduras según diseño.

Estado de la superficie: conforme a norma EN 10163-3: 2004, clase C, subclase 1

ACB – Castellated beams with sinusoidal openings “ANGELINA®” (continued)

Dimensions: The dimensions of the castellated beams are variable.

Execution of the welds according to design.

Surface condition: according to EN 10163-3: 2004, class C, subclass 1

ACB - Travi alveolari con aperture sinusoidali “ANGELINA®” (continua)

Dimensioni: le dimensioni delle Travi alveolari sono variabili.

La esecuzione delle saldature dipende dal disegno

Condizioni di superficie: Secondo EN 10163-3: 2004, classe C, sottoclasse 1

Perfil básico Base Profiles Profilo di base	HE					
	Jácena / Floor beam / Travi per solai					
	$y = \left(0,5 \cdot \frac{a}{2} \right) \cdot \sin \left[\pi \cdot \left(\frac{x}{b} + \frac{3}{2} \right) \right] + \frac{a}{4}$					
G	H _t	a	b	w	A _L	
kg/m	mm	mm	mm	mm	m ² /m	

HE 900 AA	198,0	1600,0	1460,0	2174,8	250	2,858
HE 900 A	252,0	1620,0	1460,0	2201,9	250	2,896
HE 900 B	291,0	1630,0	1460,0	2215,5	250	2,911
HE 900 M	333,0	1640,0	1460,0	2229,1	250	2,934
HE 900 x 391	391,0	1652,0	1460,0	2245,4	250	2,970
HE 900 x 466	466,0	1668,0	1460,0	2267,2	250	3,012
HE 1000 AA	222,0	1798,0	1656,0	2443,9	250	3,056
HE 1000 A	272,0	1818,0	1656,0	2471,1	250	3,095
HE 1000 B	314,0	1828,0	1656,0	2484,7	250	3,110
HE 1000 M	349,0	1836,0	1656,0	2495,5	250	3,130
HE 1000 x 393	393,0	1844,2	1656,4	2506,7	250	3,140
HE 1000 x 409	393,0	1844,2	1656,4	2506,7	250	3,140
HE 1000 x 488	437,0	1854,0	1656,0	2520,0	250	3,170
HE 1000 x 579	494,0	1864,0	1656,0	2533,6	250	3,190

Perfil básico Base Profiles Profilo di base	HL					
	Jácena / Floor beam / Travi per solai					
	$y = \left(0,5 \cdot \frac{a}{2} \right) \cdot \sin \left[\pi \cdot \left(\frac{x}{b} + \frac{3}{2} \right) \right] + \frac{a}{4}$					
G	H _t	a	b	w	A _L	
kg/m	mm	mm	mm	mm	m ² /m	

HL 920 x 345	345,0	1712,0	1570,0	2327,0	250	3,450
HL 920 x 368	368,0	1715,4	1568,8	2331,6	250	3,460
HL 920 x 390	390,0	1720,8	1569,6	2339,0	250	3,480
HL 920 x 420	420,0	1728,2	1570,4	2349,0	250	3,500
HL 920 x 449	449,0	1732,6	1569,2	2355,0	250	3,510
HL 920 x 491	491,0	1742,0	1570,0	2367,8	250	3,520
HL 920 x 537	537,0	1749,8	1569,6	2378,4	250	3,540
HL 920 x 588	588,0	1762,2	1572,4	2395,2	250	3,570
HL 920 x 656	656,0	1772,0	1570,0	2408,5	250	3,600
HL 920 x 725	725,0	1783,8	1569,6	2424,6	250	3,630
HL 920 x 787	787,0	1796,2	1570,4	2441,4	250	3,660
HL 920 x 970	970,0	1828,2	1570,4	2484,9	250	3,740
HL 1000 AA	296,0	1810,0	1656,0	2460,2	250	3,479
HL 1000 A	321,0	1818,0	1656,0	2471,1	250	3,495
HL 1000 B	371,0	1828,0	1656,0	2484,7	250	3,510
HL 1000 M	412,0	1836,0	1656,0	2495,5	250	3,530
HL 1000 x 443	443,0	1840,2	1656,4	2501,2	250	3,530
HL 1000 x 483	483,0	1848,0	1656,0	2511,8	250	3,550
HL 1000 x 539	539,0	1857,8	1655,6	2525,2	250	3,580
HL 1000 x 554	554,0	1860,0	1656,0	2528,2	250	3,590
HL 1000 x 591	591,0	1868,2	1656,4	2539,3	250	3,600
HL 1000 x 642	642,0	1876,0	1656,0	2549,9	250	3,620
HL 1000 x 748	748,0	1896,0	1656,0	2577,1	250	3,670
HL 1000 x 883	883,0	1920,0	1656,0	2609,7	250	3,740
HL 1100 A	343,0	2038,0	1896,0	2770,1	250	3,710
HL 1100 B	390,0	2048,0	1896,0	2783,7	250	3,726
HL 1100 M	433,0	2056,0	1896,0	2794,6	250	3,746
HL 1100 R	499,0	2066,0	1896,0	2808,2	250	3,770
HL 1100 R	499,0	2066,0	1896,0	2808,2	250	3,770

Perfiles IFB

Estado de la superficie:
conforme a norma EN 10163-3: 2004, clase C, subclase 1

IFB beams

Surface condition:
according to EN 10163-3: 2004, class C, subclass 1

Travi IFB

Condizioni di superficie:
secondo EN 10163-3: 2004, classe C, sottoclasse 1

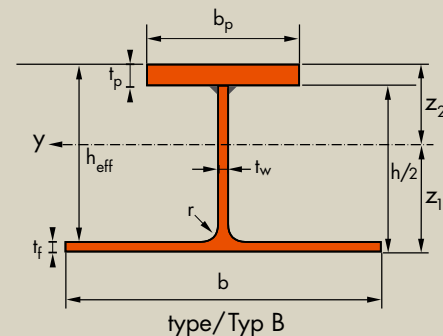
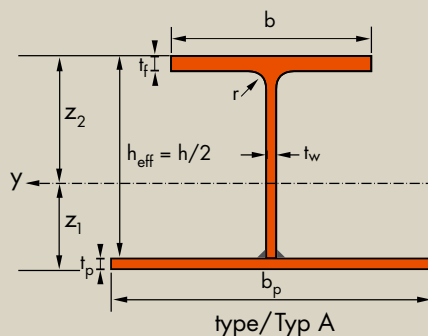

Páginas de notaciones 199-203 / Notations pages 199-203 / Pagine di annotazioni 199-203

Denominación Designation Designazione			Dimensiones Dimensions Dimensioni						Propiedades del perfil Section properties Proprietà geometriche del profilo				
$b_p \times t_p$ mm x mm	type Typ	G kg/m	h_{eff} mm	b mm	t_w mm	t_f mm	r mm	A mm ² x10 ²	I_y mm ⁴ x10 ⁴	W_{ely} mm ³ x10 ³	z_1 mm x10	z_2 mm x10	
1/2 IPE 400	380 x 10	A	63,0	200,0	180,0	8,6	13,5	21,0	80,2	6558	543	8,9	12,1
1/2 IPE O 400	390 x 12	A	74,6	202,0	182,0	9,7	15,5	21,0	95,0	7893	627	8,8	12,6
1/2 IPE 450	390 x 12	A	75,5	225,0	190,0	9,4	14,6	21,0	96,2	9857	707	9,8	13,9
1/2 IPE O 450	400 x 12	A	83,9	228,0	192,0	11,0	17,6	21,0	106,8	11230	833	10,5	13,5
1/2 IPE 500	400 x 12	A	83,0	250,0	200,0	10,2	16,0	21,0	105,8	13332	895	11,3	14,9
1/2 IPE O 500	410 x 15	A	101,9	253,0	202,0	12,0	19,0	21,0	129,9	16701	1071	11,2	15,6
1/2 IPE 550	410 x 15	A	101,0	275,0	210,0	11,1	17,2	24,0	128,7	19499	1145	12,0	17,0
1/2 IPE O 550	420 x 15	A	110,7	278,0	212,0	12,7	20,2	24,0	141,0	21825	1318	12,7	16,6
1/2 IPE 600	420 x 15	A	110,7	300,0	220,0	12,0	19,0	24,0	141,0	25375	1420	13,6	17,9
1/2 IPE O 600	430 x 15	A	127,9	305,0	224,0	15,0	24,0	24,0	162,9	29830	1749	14,9	17,1
1/2 IPE O 600	430 x 20	A	144,7	305,0	224,0	15,0	24,0	24,0	184,4	34206	1816	13,7	18,8
1/2 HE 220 M	430 x 15	A	109,3	120,0	226,0	15,5	26,0	18,0	139,2	4209	581	6,3	7,2
1/2 HE 240 M	450 x 20	A	149,0	135,0	248,0	18,0	32,0	21,0	189,8	7323	873	7,1	8,4
1/2 HE 260 B	460 x 12	A	89,8	130,0	260,0	10,0	17,5	24,0	114,4	4251	554	6,5	7,7
1/2 HE 260 M	470 x 20	A	160,0	145,0	268,0	18,0	32,5	24,0	203,8	9087	1038	7,7	8,8
1/2 HE 280 M	500 x 20	A	172,8	155,0	288,0	18,5	33,0	24,0	220,1	11218	1219	8,3	9,2
1/2 HE 280 M	500 x 25	A	192,4	155,0	288,0	18,5	33,0	24,0	245,1	12853	1275	7,9	10,1
1/2 HE 300 B	500 x 15	A	117,4	150,0	300,0	11,0	19,0	27,0	149,5	7482	820	7,4	9,1
1/2 HE 300 M	500 x 25	A	217,1	170,0	310,0	21,0	39,0	27,0	276,5	17044	1675	9,3	10,2
1/2 HE 320 B	500 x 15	A	122,2	160,0	300,0	11,5	20,5	27,0	155,7	8805	932	8,1	9,4
1/2 HE 320 M	500 x 25	A	220,6	179,5	309,0	21,0	40,0	27,0	281,0	19208	1812	9,9	10,6
1/2 HE 320 M	500 x 30	A	240,2	179,5	309,0	21,0	40,0	27,0	306,0	21543	1885	9,5	11,4
1/2 HE 340 B	500 x 15	A	126,0	170,0	300,0	12,0	21,5	27,0	160,4	10173	1034	8,7	9,8
1/2 HE 340 M	500 x 25	A	222,1	188,5	309,0	21,0	40,0	27,0	282,9	21298	1928	10,3	11,0
1/2 HE 340 M	500 x 30	A	241,7	188,5	309,0	21,0	40,0	27,0	307,9	23848	2002	9,9	11,9
1/2 HE 360 B	500 x 15	A	129,8	180,0	300,0	12,5	22,5	27,0	165,3	11660	1142	9,3	10,2
1/2 HE 360 M	500 x 25	A	223,3	197,5	308,0	21,0	40,0	27,0	284,4	23466	2039	10,7	11,5
1/2 HE 360 M	500 x 30	A	242,9	197,5	308,0	21,0	40,0	27,0	309,4	26233	2115	10,3	12,4

Perfiles IFB (continúa)

Estado de la superficie:
conforme a norma EN 10163-3: 2004, clase C, subclase 1

IFB beams (continued)

Surface condition:
according to EN 10163-3: 2004, class C, subclass 1

Travi IFB (continua)

Condizioni di superficie:
secondo EN 10163-3: 2004, classe C, sottoclasse 1

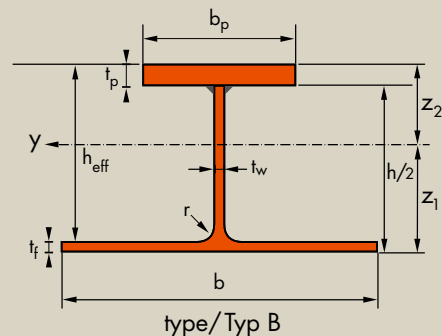
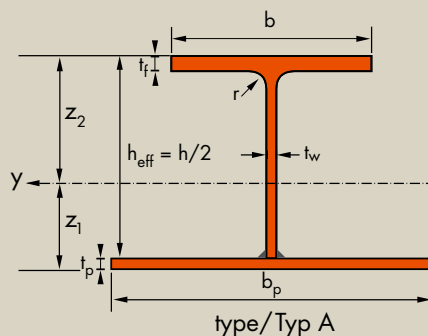

Denominación Designation Designazione				Dimensiones Dimensions Dimensioni					Propiedades del perfil Section properties Proprietà geometriche del profilo				
$b_p \times t_p$ mm x mm	type Typ	G kg/m	h_{eff} mm	b mm	t_w mm	t_f mm	r mm	A mm ² x10 ²	I_y mm ⁴ x10 ⁴	W_{ely} mm ³ x10 ³	z_1 mm x10	z_2 mm x10	
1/2 HE 400 B	500 x 20	A	156,1	200,0	300,0	13,5	24,0	27,0	198,9	17419	1408	9,6	12,4
1/2 HE 400 M	500 x 25	A	226,0	216,0	307,0	21,0	40,0	27,0	287,9	28310	2274	11,6	12,5
1/2 HE 400 M	500 x 30	A	245,6	216,0	307,0	21,0	40,0	27,0	312,9	31558	2354	11,2	13,4
1/2 HE 450 B	500 x 20	A	164,1	225,0	300,0	14,0	26,0	27,0	209,0	22963	1708	11,1	13,4
1/2 HE 450 M	500 x 25	A	229,8	239,0	307,0	21,0	40,0	27,0	292,7	35066	2578	12,8	13,6
1/2 HE 450 M	500 x 30	A	249,4	239,0	307,0	21,0	40,0	27,0	317,7	38977	2663	12,3	14,6
1/2 HE 500 A	500 x 20	A	156,0	245,0	300,0	12,0	23,0	27,0	198,8	25944	1722	11,4	15,1
1/2 HE 500 B	500 x 20	A	172,2	250,0	300,0	14,5	28,0	27,0	219,3	29447	2035	12,5	14,5
1/2 HE 500 M	500 x 25	A	233,3	262,0	306,0	21,0	40,0	27,0	297,1	42529	2879	13,9	14,8
1/2 HE 500 M	500 x 30	A	252,9	262,0	306,0	21,0	40,0	27,0	322,1	47154	2970	13,3	15,9
1/2 HE 550 A	500 x 20	A	161,6	270,0	300,0	12,5	24,0	27,0	205,9	32356	1991	12,7	16,3
1/2 HE 550 B	500 x 20	A	178,2	275,0	300,0	15,0	29,0	27,0	227,0	36479	2336	13,9	15,6
1/2 HE 550 B	500 x 25	A	197,8	275,0	300,0	15,0	29,0	27,0	252,0	40971	2407	13,0	17,0
1/2 HE 550 M	500 x 25	A	237,2	286,0	306,0	21,0	40,0	27,0	302,2	51213	3206	15,1	16,0
1/2 HE 550 M	500 x 30	A	256,8	286,0	306,0	21,0	40,0	27,0	327,2	56660	3303	14,4	17,2
1/2 HE 550 M	500 x 35	A	276,5	286,0	306,0	21,0	40,0	27,0	352,2	61669	3388	13,9	18,2
1/2 HE 600 A	500 x 20	A	167,4	295,0	300,0	13,0	25,0	27,0	213,2	39636	2276	14,1	17,4
1/2 HE 600 B	500 x 20	A	184,5	300,0	300,0	15,5	30,0	27,0	235,0	44424	2654	15,3	16,7
1/2 HE 600 B	500 x 25	A	204,1	300,0	300,0	15,5	30,0	27,0	260,0	49850	2733	14,3	18,2
1/2 HE 600 M	500 x 30	A	260,5	310,0	305,0	21,0	40,0	27,0	331,8	66995	3631	15,5	18,5
1/2 HE 600 M	500 x 35	A	280,1	310,0	305,0	21,0	40,0	27,0	356,8	72791	3721	14,9	19,6
1/2 HE 650 A	500 x 20	A	173,3	320,0	300,0	13,5	26,0	27,0	220,8	47825	2578	15,5	18,5
1/2 HE 650 B	500 x 25	A	210,5	325,0	300,0	16,0	31,0	27,0	268,2	59791	3078	15,6	19,4
1/2 HE 650 M	500 x 25	A	244,8	334,0	305,0	21,0	40,0	27,0	311,9	71097	3863	17,5	18,4
1/2 HE 650 M	500 x 30	A	264,4	334,0	305,0	21,0	40,0	27,0	336,9	78374	3973	16,7	19,7
1/2 HE 650 M	500 x 35	A	284,1	334,0	305,0	21,0	40,0	27,0	361,9	85034	4069	16,0	20,9

Páginas de notaciones 199-203 / Notations pages 199-203 / Pagine di annotazioni 199-203

Denominación Designation Designazione				Dimensiones Dimensions Dimensioni					Propiedades del perfil Section properties Proprietà geometriche del profilo				
	b _p x t _p mm x mm	type Typ	G kg/m	h _{eff} mm	b mm	t _w mm	t _r mm	r mm	A mm ² x10 ²	I _y mm ⁴ x10 ⁴	W _{ely} mm ³ x10 ³	z ₁ mm x10	z ₂ mm x10
1/2 HE 280 A	80 x 40	B	63,3	162,0	280,0	8,0	13,0	24,0	80,6	4004	396	7,4	10,1
1/2 HE 300 A	100 x 30	B	67,7	161,0	300,0	8,5	14,0	27,0	86,3	4375	417	7,0	10,5
1/2 HP 360x109	170 x 20	B	81,2	180,3	370,5	12,9	12,9	15,2	103,5	6739	606	8,2	11,1
1/2 HP 360x109	170 x 30	B	94,6	190,3	370,5	12,9	12,9	15,2	120,5	8714	831	9,8	10,5
1/2 HP 360x133	170 x 20	B	92,8	180,4	373,3	15,6	15,6	15,2	118,2	7509	635	7,8	11,8
1/2 HP 360x133	170 x 30	B	106,2	190,4	373,3	15,6	15,6	15,2	135,2	9768	866	9,3	11,3
1/2 HP 360x152	170 x 30	B	116,1	190,3	375,5	17,9	17,9	15,2	147,9	10583	894	9,0	11,8
1/2 HP 360x152	170 x 40	B	129,4	200,3	375,5	17,9	17,9	15,2	164,9	12904	1116	10,3	11,6
1/2 HP 400x122	190 x 20	B	91,0	180,0	390,0	14,0	14,0	15,0	116,0	7597	678	8,2	11,2
1/2 HP 400x122	190 x 30	B	105,9	190,0	390,0	14,0	14,0	15,0	135,0	9837	931	9,8	10,6
1/2 HP 400x140	190 x 30	B	114,8	190,0	392,0	16,0	16,0	15,0	146,3	10658	958	9,5	11,1
1/2 HP 400x140	190 x 40	B	129,7	200,0	392,0	16,0	16,0	15,0	165,3	12931	1199	10,8	10,8
1/2 HP 400x158	190 x 30	B	123,8	190,0	394,0	18,0	18,0	15,0	157,7	11435	984	9,2	11,6
1/2 HP 400x158	190 x 40	B	138,7	200,0	394,0	18,0	18,0	15,0	176,7	13926	1231	10,5	11,3
1/2 HP 400x176	190 x 30	B	132,8	190,0	396,0	20,0	20,0	15,0	169,2	12179	1010	8,9	12,1
1/2 HP 400x176	190 x 40	B	147,7	200,0	396,0	20,0	20,0	15,0	188,2	14874	1262	10,2	11,8
1/2 HP 400x194	190 x 30	B	141,9	190,0	398,0	22,0	22,0	15,0	180,7	12899	1036	8,7	12,5
1/2 HP 400x194	190 x 40	B	156,8	200,0	398,0	22,0	22,0	15,0	199,7	15785	1292	10,0	12,2

Perfiles SFB

Estado de la superficie: conforme a norma EN 10163-3: 2004, clase C, subclase 1

SFB beams

Surface condition: according to EN 10163-3: 2004, class C, subclass 1

Travi SFB

Condizioni di superficie: secondo EN 10163-3: 2004, classe C, sottoclasse 1

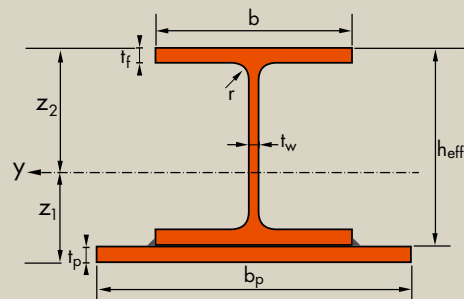

Denominación Designation Designazione			Dimensiones Dimensions Dimensioni					Propiedades de perfil Section properties Proprietà geometriche del profilo				
	$b_p \times t_p$ mm x mm	G kg/m	h_{eff} mm	b mm	t_w mm	t_f mm	r mm	A mm ² x10 ²	I_y mm ⁴ x10 ⁴	W_{ely} mm ³ x10 ³	z_1 mm x10	z_2 mm x10
HEB 140	340 x 10	60,4	140,0	140,0	7,0	12,0	12,0	77,0	2580	250	4,7	10,3
HEM 140	350 x 10	90,7	160,0	146,0	13,0	22,0	12,0	115,6	5057	478	6,4	10,6
HEM 140	350 x 15	104,4	160,0	146,0	13,0	22,0	12,0	133,1	5735	501	6,0	11,5
HEM 140	350 x 20	118,2	160,0	146,0	13,0	22,0	12,0	150,6	6348	521	5,8	12,2
HEB 160	360 x 10	70,8	160,0	160,0	8,0	13,0	15,0	90,3	4058	356	5,6	11,4
HEM 160	370 x 10	105,2	180,0	166,0	14,0	23,0	15,0	134,1	7519	647	7,4	11,6
HEM 160	370 x 15	119,8	180,0	166,0	14,0	23,0	15,0	152,6	8465	675	7,0	12,5
HEM 160	370 x 20	134,3	180,0	166,0	14,0	23,0	15,0	171,1	9322	699	6,7	13,3
HEM 160	370 x 25	148,8	180,0	166,0	14,0	23,0	15,0	189,6	10122	723	6,5	14,0
HEB 180	380 x 10	81,1	180,0	180,0	8,5	14,0	15,0	103,3	6002	480	6,5	12,5
HEB 180	380 x 15	96,0	180,0	180,0	8,5	14,0	15,0	122,3	6734	497	6,0	13,5
HEM 180	390 x 10	119,5	200,0	186,0	14,5	24,0	15,0	152,3	10685	842	8,3	12,7
HEM 180	390 x 15	134,8	200,0	186,0	14,5	24,0	15,0	171,8	11952	875	7,8	13,7
HEM 180	390 x 20	150,1	200,0	186,0	14,5	24,0	15,0	191,3	13098	904	7,5	14,5
HEM 180	390 x 25	165,4	200,0	186,0	14,5	24,0	15,0	210,8	14165	932	7,3	15,2
HEB 200	400 x 10	92,7	200,0	200,0	9,0	15,0	18,0	118,1	8616	636	7,4	13,6
HEB 200	400 x 15	108,4	200,0	200,0	9,0	15,0	18,0	138,1	9628	656	6,8	14,7
HEM 200	410 x 10	135,2	220,0	206,0	15,0	25,0	18,0	172,3	14777	1076	9,3	13,7
HEM 200	410 x 15	151,3	220,0	206,0	15,0	25,0	18,0	192,8	16436	1114	8,8	14,7
HEM 200	410 x 20	167,4	220,0	206,0	15,0	25,0	18,0	213,3	17937	1149	8,4	15,6
HEM 200	410 x 25	183,5	220,0	206,0	15,0	25,0	18,0	233,8	19333	1181	8,1	16,4
HEM 200	410 x 30	199,6	220,0	206,0	15,0	25,0	18,0	254,3	20656	1212	8,0	17,0
HEB 220	420 x 10	104,4	220,0	220,0	9,5	16,0	18,0	133,0	11895	813	8,4	14,6
HEB 220	420 x 15	120,9	220,0	220,0	9,5	16,0	18,0	154,0	13243	838	7,7	15,8
HEB 220	420 x 20	137,4	220,0	220,0	9,5	16,0	18,0	175,0	14410	860	7,2	16,8
HEM 220	430 x 10	151,1	240,0	226,0	15,5	26,0	18,0	192,4	19826	1340	10,2	14,8
HEM 220	430 x 15	167,9	240,0	226,0	15,5	26,0	18,0	213,9	21941	1385	9,7	15,8
HEM 220	430 x 20	184,8	240,0	226,0	15,5	26,0	18,0	235,4	23859	1425	9,3	16,7
HEM 220	430 x 25	201,7	240,0	226,0	15,5	26,0	18,0	256,9	25638	1461	9,0	17,5
HEM 220	430 x 30	218,6	240,0	226,0	15,5	26,0	18,0	278,4	27320	1497	8,7	18,3

Páginas de notaciones 199-203 / Notations pages 199-203 / Pagine di annotazioni 199-203

Denominación Designation Designazione		Dimensiones Dimensions Dimensioni						Propiedades de perfil Section properties Proprietà geometriche del profilo				
	$b_p \times t_p$ mm x mm	G kg/m	h_{eff} mm	b mm	t_w mm	t_f mm	r mm	A mm ² x10 ²	I_y mm ⁴ x10 ⁴	W_{ely} mm ³ x10 ³	z_1 mm x10	z_2 mm x10
HEB 240	440 x 10	117,7	240,0	240,0	10,0	17,0	21,0	150,0	16121	1029	9,3	15,7
HEB 240	440 x 15	135,0	240,0	240,0	10,0	17,0	21,0	172,0	17883	1059	8,6	16,9
HEB 240	440 x 20	152,3	240,0	240,0	10,0	17,0	21,0	194,0	19414	1085	8,1	17,9
HEM 240	450 x 10	192,0	270,0	248,0	18,0	32,0	21,0	244,6	31491	1959	11,9	16,1
HEM 240	450 x 15	209,7	270,0	248,0	18,0	32,0	21,0	267,1	34545	2020	11,4	17,1
HEM 240	450 x 20	227,3	270,0	248,0	18,0	32,0	21,0	289,6	37361	2075	11,0	18,0
HEM 240	450 x 25	245,0	270,0	248,0	18,0	32,0	21,0	312,1	40001	2126	10,7	18,8
HEM 240	450 x 30	262,6	270,0	248,0	18,0	32,0	21,0	334,6	42510	2174	10,4	19,6
HEM 240	450 x 35	280,3	270,0	248,0	18,0	32,0	21,0	357,1	44923	2221	10,3	20,2
HEM 240	450 x 40	298,0	270,0	248,0	18,0	32,0	21,0	379,6	47268	2267	10,1	20,9
HEB 260	460 x 10	129,1	260,0	260,0	10,0	17,5	24,0	164,4	20962	1249	10,2	16,8
HEB 260	460 x 15	147,1	260,0	260,0	10,0	17,5	24,0	187,4	23176	1283	9,4	18,1
HEB 260	460 x 20	165,2	260,0	260,0	10,0	17,5	24,0	210,4	25099	1313	8,9	19,1
HEM 260	470 x 10	209,3	290,0	268,0	18,0	32,5	24,0	266,6	40022	2334	12,9	17,1
HEM 260	470 x 15	227,8	290,0	268,0	18,0	32,5	24,0	290,1	43732	2402	12,3	18,2
HEM 260	470 x 20	246,2	290,0	268,0	18,0	32,5	24,0	313,6	47153	2463	11,9	19,1
HEM 260	470 x 25	264,7	290,0	268,0	18,0	32,5	24,0	337,1	50357	2519	11,5	20,0
HEM 260	470 x 30	283,1	290,0	268,0	18,0	32,5	24,0	360,6	53396	2573	11,2	20,8
HEM 260	470 x 35	301,6	290,0	268,0	18,0	32,5	24,0	384,1	56312	2624	11,0	21,5
HEM 260	470 x 40	320,0	290,0	268,0	18,0	32,5	24,0	407,6	59136	2675	10,9	22,1
HEB 280	480 x 10	140,8	280,0	280,0	10,5	18,0	24,0	179,4	26666	1491	11,1	17,9
HEB 280	480 x 15	159,6	280,0	280,0	10,5	18,0	24,0	203,4	29402	1530	10,3	19,2
HEB 280	480 x 20	178,5	280,0	280,0	10,5	18,0	24,0	227,4	31782	1563	9,7	20,3
HEM 280	490 x 10	227,0	310,0	288,0	18,5	33,0	24,0	289,2	49970	2744	13,8	18,2
HEM 280	490 x 15	246,2	310,0	288,0	18,5	33,0	24,0	313,7	54422	2819	13,2	19,3
HEM 280	490 x 20	265,5	310,0	288,0	18,5	33,0	24,0	338,2	58528	2886	12,7	20,3
HEM 280	490 x 25	284,7	310,0	288,0	18,5	33,0	24,0	362,7	62371	2948	12,3	21,2
HEM 280	490 x 30	303,9	310,0	288,0	18,5	33,0	24,0	387,2	66010	3007	12,0	22,0
HEM 280	490 x 35	323,2	310,0	288,0	18,5	33,0	24,0	411,7	69494	3063	11,8	22,7
HEM 280	490 x 40	342,4	310,0	288,0	18,5	33,0	24,0	436,2	72860	3118	11,6	23,4

Perfiles SFB (continúa)

Estado de la superficie: conforme a norma EN 10163-3: 2004, clase C, subclase 1

SFB beams (continued)

Surface condition: according to EN 10163-3: 2004, class C, subclass 1

Travi SFB (continua)

Condizioni di superficie: secondo EN 10163-3: 2004, classe C, sottoclasse 1

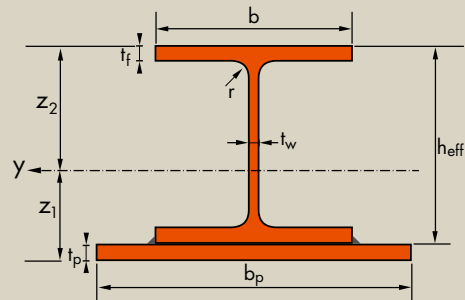

Denominación Designation Designazione			Dimensiones Dimensions Dimensioni					Propiedades de perfil Section properties Proprietà geometriche del profilo				
	$b_p \times t_p$ mm x mm	G kg/m	h_{eff} mm	b mm	t_w mm	t_f mm	r mm	A mm ² x10 ²	I_y mm ⁴ x10 ⁴	W_{ely} mm ³ x10 ³	z_1 mm x10	z_2 mm x10
HEB 300	500 x 10	156,3	300,0	300,0	11,0	19,0	27,0	199,1	34165	1808	12,1	18,9
HEB 300	500 x 15	175,9	300,0	300,0	11,0	19,0	27,0	224,1	37557	1853	11,2	20,3
HEB 300	500 x 20	195,5	300,0	300,0	11,0	19,0	27,0	249,1	40521	1891	10,6	21,4
HEB 300	500 x 25	215,2	300,0	300,0	11,0	19,0	27,0	274,1	43185	1927	10,1	22,4
HEM 300	510 x 10	278,0	340,0	310,0	21,0	39,0	27,0	354,1	72574	3718	15,5	19,5
HEM 300	510 x 15	298,0	340,0	310,0	21,0	39,0	27,0	379,6	78460	3813	14,9	20,6
HEM 300	510 x 20	318,0	340,0	310,0	21,0	39,0	27,0	405,1	83961	3899	14,5	21,5
HEM 300	510 x 25	338,0	340,0	310,0	21,0	39,0	27,0	430,6	89158	3980	14,1	22,4
HEM 300	510 x 30	358,0	340,0	310,0	21,0	39,0	27,0	456,1	94113	4056	13,8	23,2
HEM 300	510 x 35	378,0	340,0	310,0	21,0	39,0	27,0	481,6	98877	4129	13,6	23,9
HEM 300	510 x 40	398,1	340,0	310,0	21,0	39,0	27,0	507,1	103490	4199	13,4	24,6
HEB 320	500 x 10	165,9	320,0	300,0	11,5	20,5	27,0	211,3	41220	2071	13,1	19,9
HEB 320	500 x 15	185,5	320,0	300,0	11,5	20,5	27,0	236,3	45202	2121	12,2	21,3
HEB 320	500 x 20	205,2	320,0	300,0	11,5	20,5	27,0	261,3	48699	2164	11,5	22,5
HEB 320	500 x 25	224,8	320,0	300,0	11,5	20,5	27,0	286,3	51847	2203	11,0	23,5

Perfiles británicos

- 98 UB Perfiles I británicos de alas paralelas
- 104 J Perfiles I británicos de alas inclinadas
- 106 UC Perfiles H británicos de alas anchas y caras paralelas para pilares
- 108 UBP Perfiles H británicos de alas anchas y caras paralelas para pilotes
- 110 PFC Perfiles U británicos de alas paralelas
- 112 CH Perfiles U británicos de alas inclinadas

British Sections

- 98 UB British universal beams
- 104 J British joists with taper flanges
- 106 UC British universal columns
- 108 UBP British universal bearing piles with wide flanges
- 110 PFC British parallel flange channels
- 112 CH British channels with taper flanges

Profili britannici

- 98 UB Profili I ad ali parallele
- 104 J Profili I ad ali inclinate
- 106 UC Profili H portanti
- 108 UBP Profili H portanti ad ali larghe
- 110 PFC Profili U ad ali parallele
- 112 CH Profili U ad ali inclinate



Perfiles I británicos de alas paralelas

Dimensiones: BS 4-1: 2005 UB 127-914
 ASTM A 6/A 6M - 07 UB 1016
 Tolerancias: EN 10034: 1993 UB 127-914
 ASTM A 6/A 6M - 07 UB 1016

Estado de la superficie: conforme a norma EN 10163-3: 2004, clase C, subclase 1

British universal beams

Dimensions: BS 4-1: 2005 UB 127-914
 ASTM A 6/A 6M - 07 UB 1016
 Tolerances: EN 10034: 1993 UB 127-914
 ASTM A 6/A 6M - 07 UB 1016

Surface condition: according to EN 10163-3: 2004, class C, subclass 1

Profili I ad ali parallele

Dimensioni: BS 4-1: 2005 UB 127-914
 ASTM A 6/A 6M - 07 UB 1016
 Tolleranze: EN 10034: 1993 UB 127-914
 ASTM A 6/A 6M - 07 UB 1016

Condizioni di superficie: secondo EN 10163-3: 2004, classe C, sottoclasse 1

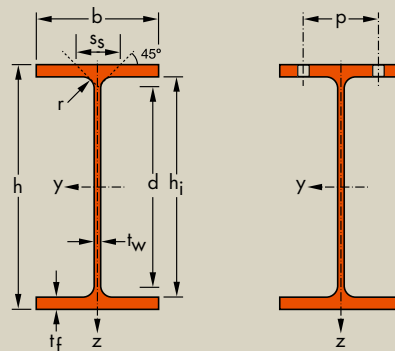

Denominación Designation Designazione	G kg/m	Dimensiones Dimensions Dimensioni					A mm ² x10 ²	Dimensiones de construcción Dimensions for detailing Dimensioni di dettaglio					Superficie Surface Superficie	
		h mm	b mm	t _w mm	t _r mm	r mm		h _i mm	d mm	Ø mm	p _{min} mm	p _{max} mm	A _L m ² /m	A _G m ² /t
UB 127 x 76 x 13 ^{*/*}	13,0	127,0	76,0	4,0	7,6	7,6	16,52	111,8	96,6	-	-	-	0,537	41,41
UB 152 x 89 x 16 ^{*/*}	16,0	152,4	88,7	4,5	7,7	7,6	20,32	137	121,8	-	-	-	0,638	39,97
UB 178 x 102 x 19 ^{*/*}	19,0	177,8	101,2	4,8	7,9	7,6	24,26	162	146,8	M10	50	58	0,738	38,74
UB 203 x 102 x 23 ^{*/*}	23,1	203,2	101,8	5,4	9,3	7,6	29,40	184,6	169,4	M10	54	58	0,790	34,22
UB 203 x 133 x 25 ^{*/*}	25,1	203,2	133,2	5,7	7,8	7,6	31,97	187,6	172,4	M16	64	70	0,915	36,45
UB 203 x 133 x 30 ^{*/*}	30,0	206,8	133,9	6,4	9,6	7,6	38,21	187,6	172,4	M16	66	70	0,923	30,78
UB 254 x 102 x 22 ^{*/*}	22,0	254,0	101,6	5,7	6,8	7,6	28,02	240,4	225,2	M10	50	58	0,890	40,47
UB 254 x 102 x 25 ^{*/*}	25,2	257,2	101,9	6,0	8,4	7,6	32,04	240,4	225,2	M10	52	58	0,897	35,66
UB 254 x 102 x 28 ^{*/*}	28,3	260,4	102,2	6,3	10,0	7,6	36,08	240,4	225,2	M12	54	54	0,904	31,92
UB 254 x 146 x 31 ^{*/*}	31,1	251,4	146,1	6,0	8,6	7,6	39,68	234,2	219	M16	66	82	1,062	34,10
UB 254 x 146 x 37 ^{*/*}	37,0	256,0	146,4	6,3	10,9	7,6	47,17	234,2	219	M16	66	82	1,072	28,95
UB 254 x 146 x 43 ^{*/*}	43,0	259,6	147,3	7,2	12,7	7,6	54,77	234,2	219	M16	66	84	1,081	25,14
UB 305 x 102 x 25 [*]	24,8	305,1	101,6	5,8	7,0	7,6	31,60	291,1	275,9	M10	56	58	0,992	39,98
UB 305 x 102 x 28 [*]	28,2	308,7	101,8	6,0	8,8	7,6	35,88	291,1	275,9	M10	58	58	1,000	35,49
UB 305 x 102 x 33 [*]	32,8	312,7	102,4	6,6	10,8	7,6	41,83	291,1	275,9	M10	58	60	1,009	30,72
UB 305 x 127 x 37 [*]	37,0	304,4	123,4	7,1	10,7	8,9	47,18	283	265,2	M16	67	69	1,073	28,97
UB 305 x 127 x 42 [*]	41,9	307,2	124,3	8,0	12,1	8,9	53,40	283	265,2	M16	68	70	1,080	25,77
UB 305 x 127 x 48 [*]	48,1	311,0	125,3	9,0	14,0	8,9	61,23	283	265,2	M16	69	71	1,090	22,67
UB 305 x 165 x 40 [*]	40,3	303,4	165,0	6,0	10,2	8,9	51,32	283	265,2	M22	76	84	1,240	30,77
UB 305 x 165 x 46 [*]	46,1	306,6	165,7	6,7	11,8	8,9	58,75	283	265,2	M22	76	84	1,247	27,05
UB 305 x 165 x 54 [*]	54,0	310,4	166,9	7,9	13,7	8,9	68,77	283	265,2	M22	78	84	1,257	23,29
UB 356 x 127 x 33 [*]	33,1	349,0	125,4	6,0	8,5	10,2	42,13	332	311,6	M12	62	74	1,170	35,38
UB 356 x 127 x 39 [*]	39,1	353,4	126,0	6,6	10,7	10,2	49,77	332	311,6	M12	62	74	1,180	30,21

+ Pedido mínimo: 40 t por perfil y calidad o según acuerdo.
 * Tonelaje mínimo y condiciones de suministro previo acuerdo.

+ Minimum order: 40t per section and grade or upon agreement.
 * Minimum tonnage and delivery conditions upon agreement.

+ Ordine minimo: 40t per sezione e qualità o da concordare.
 * Tonnellaggio minimo e condizioni di fornitura da concordare.

Páginas de notaciones 199-203 / Notations pages 199-203 / Pagine di annotazioni 199-203

Denominación Designation Designazione	Propiedades de perfil / Section properties / Proprietà geometriche del profilo												Classification EN 1993-1-1: 2005						EN 10025-2: 2004	EN 10025-4: 2004	EN 10225:2001	
	G kg/m	eje fuerte y-y strong axis y-y asse forte y-y					eje débil z-z weak axis z-z asse debole z-z					Pure bending y-y			Pure compression							
		I_y mm ⁴ x10 ⁴	$W_{el,y}$ mm ³ x10 ³	$W_{ply}♦$ mm ³ x10 ³	i_y mm x10	A_{vz} mm ² x10 ²	I_z mm ⁴ x10 ⁴	$W_{el,z}$ mm ³ x10 ³	$W_{pl,z}♦$ mm ³ x10 ³	i_z mm x10	s_s mm	I_t mm ⁴ x10 ⁴	I_w mm ⁶ x10 ⁹	S235	S355	S460	S235	S355				S460
UB 127 x 76 x 13	13,0	473,4	74,56	84,15	5,35	6,43	55,74	14,67	22,58	1,84	28,10	2,80	1,98	1	1	-	1	1	-	✓		
UB 152 x 89 x 16	16,0	834,3	109,5	123,3	6,41	8,18	89,75	20,24	31,18	2,10	28,80	3,55	4,69	1	1	-	1	2	-	✓		
UB 178 x 102 x 19	19,0	1356	152,5	171,3	7,48	9,85	136,7	27,02	41,59	2,37	29,50	4,42	9,85	1	1	1	1	2	4	✓	✓	✓
UB 203 x 102 x 23	23,1	2105	207,2	234,1	8,46	12,38	163,9	32,19	49,75	2,36	32,90	7,02	15,37	1	1	1	1	3	4	✓	✓	✓
UB 203 x 133 x 25	25,1	2340	230,3	257,7	8,56	12,82	307,6	46,19	70,94	3,10	30,20	6,10	29,33	1	1	3	1	2	4	✓	✓	✓
UB 203 x 133 x 30	30,0	2896	280,0	314,4	8,71	14,58	384,7	57,45	88,22	3,17	34,50	10,43	37,34	1	1	1	1	2	2	✓	✓	✓
UB 254 x 102 x 22	22,0	2841	223,7	259,0	10,07	15,62	119,3	23,49	37,27	2,06	28,20	4,35	18,16	1	1	-	3	4	-	✓		
UB 254 x 102 x 25	25,2	3415	265,5	305,5	10,32	16,70	148,7	29,18	46,01	2,15	31,70	6,56	22,92	1	1	-	2	4	-	✓		
UB 254 x 102 x 28	28,3	4005	307,6	352,8	10,54	17,79	178,5	34,94	54,85	2,22	35,20	9,66	27,89	1	1	-	2	4	-	✓		
UB 254 x 146 x 31	31,1	4413	351,1	393,1	10,55	16,37	447,5	61,26	94,13	3,36	32,10	8,68	65,88	1	1	3	2	4	4	✓	✓	✓
UB 254 x 146 x 37	37,0	5537	432,6	483,2	10,83	17,59	570,6	77,96	119,4	3,48	37,00	15,37	85,61	1	1	1	2	4	4	✓	✓	✓
UB 254 x 146 x 43	43,0	6544	504,1	566,3	10,93	20,20	677,4	91,97	141,1	3,52	41,50	23,97	103,1	1	1	1	1	2	4	✓	✓	✓
UB 305 x 102 x 25	24,8	4455	292,1	342,0	11,87	18,85	122,9	24,20	38,81	1,97	28,70	4,98	27,18	1	1	-	4	4	-	✓		
UB 305 x 102 x 28	28,2	5366	347,6	402,9	12,23	19,83	155,4	30,53	48,45	2,08	32,50	7,51	34,79	1	1	-	4	4	-	✓		
UB 305 x 102 x 33	32,8	6501	415,8	480,8	12,47	22,06	194,1	37,91	60,04	2,15	37,10	12,29	44,04	1	1	-	3	4	-	✓		
UB 305 x 127 x 37	37,0	7171	471,1	539,4	12,33	23,44	336,2	54,49	85,41	2,67	38,93	14,96	72,26	1	1	1	2	4	4	✓	✓	✓
UB 305 x 127 x 42	41,9	8196	533,6	613,5	12,39	26,44	388,8	62,55	98,41	2,70	42,63	21,42	84,32	1	1	1	2	3	4	✓	✓	✓
UB 305 x 127 x 48	48,1	9575	615,7	710,7	12,50	29,90	461,0	73,59	116,1	2,74	47,43	32,18	101,2	1	1	1	1	2	3	✓	✓	✓
UB 305 x 165 x 40	40,3	8503	560,5	623,1	12,87	20,09	764,4	92,65	141,7	3,86	36,83	14,74	164,1	1	1	-	4	4	-	✓		
UB 305 x 165 x 46	46,1	9899	645,7	720,0	12,98	22,53	895,7	108,1	165,5	3,90	40,73	22,20	194,4	1	1	-	3	4	-	✓		
UB 305 x 165 x 54	54,0	11700	753,6	846,1	13,04	26,56	1063	127,4	195,6	3,93	45,73	34,90	233,6	1	1	-	2	3	-	✓		
UB 356 x 127 x 33	33,1	8249	472,7	542,9	13,99	23,06	280,2	44,69	70,29	2,58	34,95	8,97	80,97	1	1	-	4	4	-	✓		
UB 356 x 127 x 39	39,1	10170	575,6	658,5	14,30	25,69	357,8	56,80	89,05	2,68	39,95	15,15	104,7	1	1	-	4	4	-	✓		

♦ W_{pl} : para el diseño plástico la sección debe pertenecer a la clase 1 o 2 según la capacidad de rotación que se precise. Véase pág. 203.

♦ W_{pl} : for plastic design, the shape must belong to class 1 or 2 according to the required rotation capacity. See page 203.

♦ W_{pl} : per il calcolo plastico, la sezione trasversale deve appartenere alla classe 1 o 2, conformemente alla capacità di rotazione richiesta. Vedere pagina 203.

Perfiles I británicos de alas paralelas (continúa)

Dimensiones: BS 4-1: 2005 UB 127-914

ASTM A 6/A 6M - 07 UB 1016

Tolerancias: EN 10034: 1993 UB 127-914

ASTM A 6/A 6M - 07 UB 1016

Estado de la superficie: conforme a norma EN 10163-3: 2004, clase C, subclase 1

British universal beams (continued)

Dimensiones: BS 4-1: 2005 UB 127-914

ASTM A 6/A 6M - 07 UB 1016

Tolerancias: EN 10034: 1993 UB 127-914

ASTM A 6/A 6M - 07 UB 1016

Surface condition: according to EN 10163-3: 2004, class C, subclass 1

Profili I ad ali parallele (continua)

Dimensioni: BS 4-1: 2005 UB 127-914

ASTM A 6/A 6M - 07 UB 1016

Tolleranze: EN 10034: 1993 UB 127-914

ASTM A 6/A 6M - 07 UB 1016

Condizioni di superficie: secondo EN 10163-3: 2004, classe C, sottoclasse 1

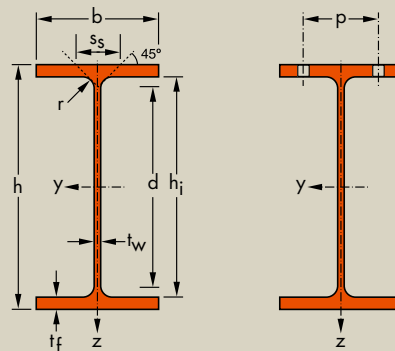

Denominación Designation Designazione	G kg/m	Dimensiones Dimensions Dimensioni					A mm ² x10 ²	Dimensiones de construcción Dimensions for detailing Dimensioni di dettaglio					Superficie Surface Superficie	
		h mm	b mm	t _w mm	t _r mm	r mm		h _i mm	d mm	Ø mm	p _{min} mm	p _{max} mm	A _L m ² /m	A _G m ² /t
UB 356 x 171 x 45 ⁺	45,0	351,4	171,1	7,0	9,7	10,2	57,33	332	311,6	M22	82	90	1,356	30,13
UB 356 x 171 x 51 ⁺	51,0	355,0	171,5	7,4	11,5	10,2	64,91	332	311,6	M22	82	90	1,364	26,76
UB 356 x 171 x 57 ⁺	57,0	358,0	172,2	8,1	13,0	10,2	72,56	332	311,6	M22	82	90	1,371	24,07
UB 356 x 171 x 67 ⁺	67,1	363,4	173,2	9,1	15,7	10,2	85,49	332	311,6	M22	84	92	1,384	20,62
UB 406 x 140 x 39 ⁺	39,0	398,0	141,8	6,4	8,6	10,2	49,65	380,8	360,4	M16	68	78	1,333	34,20
UB 406 x 140 x 46 ⁺	46,0	403,2	142,2	6,8	11,2	10,2	58,64	380,8	360,4	M16	68	78	1,344	29,20
UB 406 x 178 x 54 ⁺	54,1	402,6	177,7	7,7	10,9	10,2	68,95	380,8	360,4	M24	88	90	1,483	27,40
UB 406 x 178 x 60 ⁺	60,1	406,4	177,9	7,9	12,8	10,2	76,52	380,8	360,4	M24	88	90	1,491	24,82
UB 406 x 178 x 67 ⁺	67,1	409,4	178,8	8,8	14,3	10,2	85,54	380,8	360,4	M24	88	90	1,499	22,32
UB 406 x 178 x 74 ⁺	74,2	412,8	179,5	9,5	16,0	10,2	94,51	380,8	360,4	M24	88	92	1,507	20,31
UB 457 x 152 x 52 ⁺	52,3	449,8	152,4	7,6	10,9	10,2	66,64	428	407,6	M20	76	76	1,476	28,22
UB 457 x 152 x 60 ⁺	59,8	454,6	152,9	8,1	13,3	10,2	76,23	428	407,6	M20	76	76	1,487	24,85
UB 457 x 152 x 67 ⁺	67,2	458,0	153,8	9,0	15,0	10,2	85,55	428	407,6	M20	78	78	1,496	22,27
UB 457 x 152 x 74 ⁺	74,2	462,0	154,4	9,6	17,0	10,2	94,48	428	407,6	M20	78	78	1,505	20,29
UB 457 x 152 x 82 ⁺	82,1	465,8	155,3	10,5	18,9	10,2	104,5	428	407,6	M20	80	80	1,514	18,45
UB 457 x 191 x 67 ⁺	67,1	453,4	189,9	8,5	12,7	10,2	85,51	428	407,6	M27	90	90	1,632	24,31
UB 457 x 191 x 74 ⁺	74,3	457,0	190,4	9,0	14,5	10,2	94,63	428	407,6	M27	90	90	1,640	22,08
UB 457 x 191 x 82 ⁺	82,0	460,0	191,3	9,9	16,0	10,2	104,5	428	407,6	M27	92	92	1,648	20,09
UB 457 x 191 x 89 ⁺	89,3	463,4	191,9	10,5	17,7	10,2	113,8	428	407,6	M27	92	92	1,656	18,54
UB 457 x 191 x 98 ⁺	98,3	467,2	192,8	11,4	19,6	10,2	125,3	428	407,6	M27	92	92	1,665	16,94
UB 533 x 210 x 82 ⁺	82,2	528,3	208,8	9,6	13,2	12,7	104,7	501,9	476,5	M27	90	108	1,851	22,52
UB 533 x 210 x 92 ⁺	92,1	533,1	209,3	10,1	15,6	12,7	117,4	501,9	476,5	M27	92	110	1,861	20,20
UB 533 x 210 x 101 ⁺	101,0	536,7	210,0	10,8	17,4	12,7	128,7	501,9	476,5	M27	92	110	1,870	18,51
UB 533 x 210 x 109 ⁺	109,0	539,5	210,8	11,6	18,8	12,7	138,9	501,9	476,5	M27	94	108	1,877	17,22
UB 533 x 210 x 122 ⁺	122,0	544,5	211,9	12,7	21,3	12,7	155,4	501,9	476,5	M27	94	110	1,889	15,49
UB 610 x 229 x 101 ⁺	101,2	602,6	227,6	10,5	14,8	12,7	128,9	573	547,6	M27	92	126	2,073	20,48
UB 610 x 229 x 113 ⁺	113,0	607,6	228,2	11,1	17,3	12,7	143,9	573	547,6	M27	92	126	2,084	18,44
UB 610 x 229 x 125 ⁺	125,1	612,2	229,0	11,9	19,6	12,7	159,3	573	547,6	M27	94	128	2,095	16,75
UB 610 x 229 x 140 ⁺	139,9	617,2	230,2	13,1	22,1	12,7	178,2	573	547,6	M27	94	128	2,107	15,06

+ Pedido mínimo: 40 t por perfil y calidad o según acuerdo.
* Tonelaje mínimo y condiciones de suministro previo acuerdo.

+ Minimum order: 40t per section and grade or upon agreement.
* Minimum tonnage and delivery conditions upon agreement.

+ Ordine minimo: 40t per sezione e qualità o da concordare.
* Tonnellaggio minimo e condizioni di fornitura da concordare.

Páginas de notaciones 199-203 / Notations pages 199-203 / Pagine di annotazioni 199-203

Denominación Designation Designazione	Propiedades de perfil / Section properties / Proprietà geometriche del profilo												Classification EN 1993-1-1: 2005						EN 10025-2: 2004	EN 10025-4: 2004	EN 10225:2001	
	G kg/m	eje fuerte y-y strong axis y-y asse forte y-y					eje débil z-z weak axis z-z asse debole z-z					Pure bending y-y			Pure compression							
		I_y mm ⁴ x10 ⁴	$W_{el,y}$ mm ³ x10 ³	$W_{ply,\blacklozenge}$ mm ³ x10 ³	i_y mm x10	A_{vz} mm ² x10 ²	I_z mm ⁴ x10 ⁴	$W_{el,z}$ mm ³ x10 ³	$W_{pl,z,\blacklozenge}$ mm ³ x10 ³	i_z mm x10	s_s mm	I_t mm ⁴ x10 ⁴	I_w mm ⁶ x10 ⁹	S235	S355	S460	S235	S355				S460
UB 356 x 171 x 45	45,0	12070	686,7	774,6	14,51	26,79	811,1	94,81	146,6	3,76	38,35	16,16	236,4	1	2	-	4	4	-	✓		
UB 356 x 171 x 51	51,0	14140	796,4	896,0	14,76	28,66	968,3	112,9	174,2	3,86	42,35	24,00	285,2	1	1	-	4	4	-	✓		
UB 356 x 171 x 57	57,0	16040	896,0	1010	14,87	31,49	1108	128,7	198,8	3,91	46,05	33,59	329,2	1	1	-	3	4	-	✓		
UB 356 x 171 x 67	67,1	19460	1071	1211	15,09	35,74	1362	157,3	243,0	3,99	52,45	55,90	410,9	1	1	-	2	4	-	✓		
UB 406 x 140 x 39	39,0	12510	628,6	723,7	15,87	27,57	409,8	57,80	90,85	2,87	35,55	10,99	154,9	1	1	-	4	4	-	✓		
UB 406 x 140 x 46	46,0	15690	778,0	887,6	16,35	29,83	538,1	75,68	118,1	3,03	41,15	19,07	206,2	1	1	-	4	4	-	✓		
UB 406 x 178 x 54	54,1	18720	930,0	1055	16,48	33,28	1021	114,9	178,3	3,85	41,45	23,50	391,0	1	1	2	4	4	4	✓	✓	✓
UB 406 x 178 x 60	60,1	21600	1063	1199	16,80	34,60	1203	135,3	209,0	3,97	45,45	33,49	465,2	1	1	1	4	4	4	✓	✓	✓
UB 406 x 178 x 67	67,1	24330	1189	1346	16,87	38,58	1365	152,7	236,6	3,99	49,35	46,40	531,7	1	1	1	3	4	4	✓	✓	✓
UB 406 x 178 x 74	74,2	27310	1323	1501	17,00	41,85	1545	172,2	267,0	4,04	53,45	63,10	607,1	1	1	1	2	4	4	✓	✓	✓
UB 457 x 152 x 52	52,3	21370	950,0	1096	17,91	36,47	645,0	84,64	133,3	3,11	41,35	21,71	309,7	1	1	2	4	4	4	✓	✓	✓
UB 457 x 152 x 60	59,8	25500	1122	1287	18,29	39,35	794,6	103,9	163,1	3,23	46,65	34,02	385,8	1	1	1	4	4	4	✓	✓	✓
UB 457 x 152 x 67	67,2	28930	1263	1453	18,39	43,82	912,6	118,7	186,7	3,27	50,95	47,95	446,2	1	1	1	4	4	4	✓	✓	✓
UB 457 x 152 x 74	74,2	32670	1414	1627	18,60	47,08	1047	135,6	213,1	3,33	55,55	66,18	516,3	1	1	1	4	4	4	✓	✓	✓
UB 457 x 152 x 82	82,1	36590	1571	1811	18,71	51,67	1185	152,5	240,4	3,37	60,25	89,65	589,1	1	1	1	3	4	4	✓	✓	✓
UB 457 x 191 x 67	67,1	29380	1296	1471	18,54	40,94	1452	152,9	237,3	4,12	45,85	37,54	703,8	1	1	1	4	4	4	✓	✓	✓
UB 457 x 191 x 74	74,3	33320	1458	1653	18,76	43,68	1671	175,5	272,1	4,20	49,95	52,14	816,6	1	1	1	4	4	4	✓	✓	✓
UB 457 x 191 x 82	82,0	37050	1611	1831	18,83	48,11	1871	195,6	303,9	4,23	53,85	69,72	920,1	1	1	1	3	4	4	✓	✓	✓
UB 457 x 191 x 89	89,3	41020	1770	2014	18,99	51,30	2089	217,8	338,4	4,29	57,85	91,26	1035	1	1	1	3	4	4	✓	✓	✓
UB 457 x 191 x 98	98,3	45730	1957	2232	19,11	55,92	2347	243,5	378,9	4,33	62,55	122,1	1173	1	1	1	2	4	4	✓	✓	✓
UB 533 x 210 x 82	82,2	47540	1800	2059	21,31	54,19	2007	192,3	300,4	4,38	50,88	52,54	1328	1	1	2	4	4	4	✓	✓	✓
UB 533 x 210 x 92	92,1	55230	2072	2360	21,69	57,61	2389	228,3	355,6	4,51	56,18	76,34	1596	1	1	1	4	4	4	✓	✓	✓
UB 533 x 210 x 101	101,0	61520	2292	2612	21,87	61,89	2692	256,4	399,4	4,57	60,48	101,6	1811	1	1	1	4	4	4	✓	✓	✓
UB 533 x 210 x 109	109,0	66820	2477	2828	21,94	66,56	2943	279,2	435,8	4,60	64,08	127,3	1989	1	1	1	3	4	4	✓	✓	✓
UB 533 x 210 x 122	122,0	76040	2793	3196	22,12	73,24	3388	319,7	499,7	4,67	70,18	179,6	2312	1	1	1	2	4	4	✓	✓	✓
UB 610 x 229 x 101	101,2	75780	2515	2881	24,24	66,86	2915	256,1	400,2	4,75	54,98	78,16	2512	1	1	2	4	4	4	✓	✓	✓
UB 610 x 229 x 113	113,0	87320	2874	3281	24,63	71,30	3434	301,0	469,3	4,88	60,58	112,3	2985	1	1	1	4	4	4	✓	✓	✓
UB 610 x 229 x 125	125,1	98610	3221	3676	24,88	76,88	3932	343,4	535,4	4,97	65,98	155,2	3444	1	1	1	4	4	4	✓	HI	HI
UB 610 x 229 x 140	139,9	111800	3622	4142	25,05	84,96	4505	391,4	611,4	5,03	72,18	217,8	3978	1	1	1	3	4	4	✓	HI	HI

◆ W_{pl} : para el diseño plástico la sección debe pertenecer a la clase 1 o 2 según la capacidad de rotación que se precise. Véase pág. 203.
 ◆ W_{pl} : for plastic design, the shape must belong to class 1 or 2 according to the required rotation capacity. See page 203.
 ◆ W_{pl} : per il calcolo plastico, la sezione trasversale deve appartenere alla classe 1 o 2, conformemente alla capacità di rotazione richiesta. Vedere pagina 203.

Perfiles I británicos de alas paralelas (continúa)

Dimensiones: BS 4-1: 2005 UB 127-914
 ASTM A 6/A 6M - 07 UB 1016
 Tolerancias: EN 10034: 1993 UB 127-914
 ASTM A 6/A 6M - 07 UB 1016

Estado de la superficie: conforme a norma EN 10163-3: 2004, clase C, subclase 1

British universal beams (continued)

Dimensiones: BS 4-1: 2005 UB 127-914
 ASTM A 6/A 6M - 07 UB 1016
 Tolerancias: EN 10034: 1993 UB 127-914
 ASTM A 6/A 6M - 07 UB 1016

Surface condition: according to EN 10163-3: 2004, class C, subclass 1

Profili I ad ali parallele (continua)

Dimensioni: BS 4-1: 2005 UB 127-914
 ASTM A 6/A 6M - 07 UB 1016
 Tolleranze: EN 10034: 1993 UB 127-914
 ASTM A 6/A 6M - 07 UB 1016

Condizioni di superficie: secondo EN 10163-3: 2004, classe C, sottoclasse 1

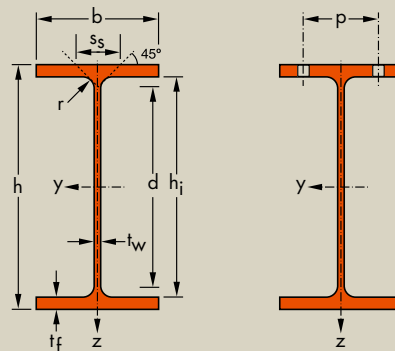

Denominación Designation Designazione	Dimensiones Dimensions Dimensioni						A mm ² x10 ²	Dimensiones de construcción Dimensions for detailing Dimensioni di dettaglio					Superficie Surface Superficie	
	G kg/m	h mm	b mm	t _w mm	t _f mm	r mm		h _i mm	d mm	Ø mm	p _{min} mm	p _{max} mm	A _L m ² /m	A _G m ² /t
UB 610 x 305 x 149 ⁺	149,1	612,4	304,8	11,8	19,7	16,5	190,0	573	540	M27	100	202	2,392	16,03
UB 610 x 305 x 179 ⁺	179,0	620,2	307,1	14,1	23,6	16,5	228,1	573	540	M27	104	206	2,412	13,47
UB 610 x 305 x 238 ⁺	238,1	635,8	311,4	18,4	31,4	16,5	303,3	573	540	M27	108	210	2,452	10,30
UB 686 x 254 x 125 ⁺	125,2	677,9	253,0	11,7	16,2	15,2	159,5	645,5	615,1	M27	98	152	2,318	18,52
UB 686 x 254 x 140 ⁺	140,1	683,5	253,7	12,4	19,0	15,2	178,4	645,5	615,1	M27	100	152	2,331	16,64
UB 686 x 254 x 152 ⁺	152,4	687,5	254,5	13,2	21,0	15,2	194,1	645,5	615,1	M27	100	152	2,341	15,36
UB 686 x 254 x 170 ⁺	170,2	692,9	255,8	14,5	23,7	15,2	216,8	645,5	615,1	M27	102	154	2,354	13,83
UB 762 x 267 x 147 ⁺	146,9	754,0	265,2	12,8	17,5	16,5	187,2	719	686	M27	104	164	2,515	17,11
UB 762 x 267 x 173 ⁺	173,0	762,2	266,7	14,3	21,6	16,5	220,4	719	686	M27	104	164	2,534	14,65
UB 762 x 267 x 197 ⁺	196,8	769,8	268,0	15,6	25,4	16,5	250,6	719	686	M27	106	166	2,552	12,97
UB 838 x 292 x 176 ⁺	175,9	834,9	291,7	14,0	18,8	17,8	224,0	797,3	761,7	M27	106	190	2,778	15,8
UB 838 x 292 x 194 ⁺	193,8	840,7	292,4	14,7	21,7	17,8	246,8	797,3	761,7	M27	108	190	2,791	14,40
UB 838 x 292 x 226 ⁺	226,5	850,9	293,8	16,1	26,8	17,8	288,6	797,3	761,7	M27	108	192	2,814	12,42
UB 914 x 305 x 201 ⁺	200,9	903,0	303,3	15,1	20,2	19,1	255,9	862,6	824,4	M27	110	202	2,956	14,72
UB 914 x 305 x 224 ⁺	224,2	910,4	304,1	15,9	23,9	19,1	285,6	862,6	824,4	M27	110	202	2,973	13,26
UB 914 x 305 x 253 ⁺	253,4	918,4	305,5	17,3	27,9	19,1	322,8	862,6	824,4	M27	112	204	2,991	11,8
UB 914 x 305 x 289 ⁺	289,1	926,6	307,7	19,5	32,0	19,1	368,3	862,6	824,4	M27	114	206	3,012	10,42
UB 914 x 419 x 343 ⁺	343,3	911,8	418,5	19,4	32,0	24,1	437,3	847,8	799,6	M27	126	312	3,417	9,955
UB 914 x 419 x 388 ⁺	388,0	921,0	420,5	21,4	36,6	24,1	494,2	847,8	799,6	M27	128	314	3,440	8,866
UB 1016 x 305 x 222 ⁺	222	970	300	16,0	21,1	30,0	282,8	928,0	868,0	M27	134	194	3,056	13,77
UB 1016 x 305 x 249 ⁺	249	980	300	16,5	26,0	30,0	316,8	928,0	868,0	M27	134	194	3,075	12,37
UB 1016 x 305 x 272 ⁺	272	990	300	16,5	31,0	30,0	346,8	928,0	868,0	M27	134	194	3,095	11,37
UB 1016 x 305 x 314 ⁺	314	1000	300	19,1	35,9	30,0	400,4	928,0	868,0	M27	136	194	3,110	9,895
UB 1016 x 305 x 350 ⁺	350	1008	302	21,1	40,0	30,0	445,1	928,0	868,0	M27	140	196	3,130	8,958
UB 1016 x 305 x 393 ⁺	393	1016	303	24,4	43,9	30,0	500,2	928,0	868,0	M27	142	198	3,144	8,006
UB 1016 x 305 x 415 ⁺	415	1020	304	26,0	46,0	30,0	528,7	928,0	868,0	M27	144	198	3,152	7,596
UB 1016 x 305 x 438 ⁺	438	1026	305	26,9	49,0	30,0	556,3	928,0	868,0	M27	146	200	3,167	7,252
UB 1016 x 305 x 494 ⁺	494	1036	309	31,0	54,0	30,0	629,1	928,0	868,0	M27	148	204	3,194	6,468
UB 1016 x 305 x 584 ⁺	584	1056	314	36,0	64,0	30,0	743,7	928,0	868,0	M27	154	208	3,244	5,557

+ Pedido mínimo: 40 t por perfil y calidad o según acuerdo.
 * Tonelaje mínimo y condiciones de suministro previo acuerdo.

+ Minimum order: 40t per section and grade or upon agreement.
 * Minimum tonnage and delivery conditions upon agreement.

+ Ordine minimo: 40t per sezione e qualità o da concordare.
 * Tonnellaggio minimo e condizioni di fornitura da concordare.

Páginas de notaciones 199-203 / Notations pages 199-203 / Pagine di annotazioni 199-203

Denominación Designation Designazione	Propiedades de perfil / Section properties / Proprietà geometriche del profilo												Classification EN 1993-1-1: 2005						EN 10025-2: 2004	EN 10025-4: 2004	EN 10225:2001	
	G kg/m	eje fuerte y-y strong axis y-y asse forte y-y					eje débil z-z weak axis z-z asse debole z-z					Pure bending y-y			Pure compression							
		I_y mm ⁴ x10 ⁴	$W_{el,y}$ mm ³ x10 ³	$W_{pl,y}♦$ mm ³ x10 ³	i_y mm x10	A_{vz} mm ² x10 ²	I_z mm ⁴ x10 ⁴	$W_{el,z}$ mm ³ x10 ³	$W_{pl,z}♦$ mm ³ x10 ³	i_z mm x10	s_s mm	I_t mm ⁴ x10 ⁴	I_w mm ⁶ x10 ⁹	S235	S355	S460	S235	S355				S460
UB 610 x 305 x 149	149,1	125900	4111	4594	25,74	78,78	9308	610,7	937,3	7,00	70,53	200,4	8165	1	1	2	4	4	4	✓	HI	HI
UB 610 x 305 x 179	179,0	153000	4935	5547	25,90	94,25	11410	743,0	1144	7,07	80,63	341,6	10140	1	1	1	3	4	4	✓	HI	HI
UB 610 x 305 x 238	238,1	209500	6589	7486	26,28	123,9	15840	1017	1574	7,23	100,5	790,6	14430	1	1	1	1	2	3	✓	HI	HI
UB 686 x 254 x 125	125,2	118000	3481	3994	27,20	84,33	4383	346,5	542,4	5,24	61,91	118,3	4786	1	1	2	4	4	4	✓	✓	✓
UB 686 x 254 x 140	140,1	136300	3987	4558	27,64	90,16	5183	408,6	638,2	5,39	68,21	170,3	5708	1	1	1	4	4	4	✓	✓	✓
UB 686 x 254 x 152	152,4	150400	4374	5000	27,83	96,35	5784	454,5	710,2	5,46	73,01	221,3	6407	1	1	1	4	4	4	✓	HI	HI
UB 686 x 254 x 170	170,2	170300	4916	5631	28,03	106,2	6630	518,4	811,4	5,53	79,71	309,8	7402	1	1	1	4	4	4	✓	HI	HI
UB 762 x 267 x 147	146,9	168500	4470	5156	30,00	102,4	5455	411,4	647,2	5,40	67,13	162,2	7377	1	1	2	4	4	4	✓	✓	✓
UB 762 x 267 x 173	173,0	205300	5387	6198	30,52	115,4	6850	513,7	807,5	5,58	76,83	270,3	9364	1	1	1	4	4	4	✓	HI	HI
UB 762 x 267 x 197	196,8	240000	6234	7167	30,94	126,8	8175	610,1	958,6	5,71	85,73	407,3	11290	1	1	1	4	4	4	✓	HI	HI
UB 838 x 292 x 176	175,9	246000	5893	6808	33,14	123,7	7799	534,7	841,9	5,90	72,45	226,2	12950	1	1	2	4	4	4	✓	✓	✓
UB 838 x 292 x 194	193,8	279200	6641	7640	33,63	130,8	9066	620,1	973,8	6,06	78,95	309,6	15160	1	1	2	4	4	4	✓	HI	HI
UB 838 x 292 x 226	226,5	339700	7985	9155	34,31	144,9	11360	773,3	1212	6,27	90,55	516,5	19230	1	1	1	4	4	4	✓	HI	HI
UB 914 x 305 x 201	200,9	325300	7204	8351	35,65	144,2	9423	621,4	982,0	6,07	77,88	297,9	18300	1	1	-	4	4	-	✓	✓	✓
UB 914 x 305 x 224	224,2	376400	8269	9535	36,30	153,2	11240	739,0	1163	6,27	86,08	427,2	22010	1	1	2	4	4	4	✓	HI	HI
UB 914 x 305 x 253	253,4	436300	9501	10940	36,76	167,8	13300	870,8	1371	6,42	95,48	630,5	26280	1	1	1	4	4	4	✓	HI	HI
UB 914 x 305 x 289	289,1	504200	10880	12570	37,00	189,8	15600	1014	1601	6,51	105,9	933,6	31090	1	1	1	4	4	4	✓	HI	HI
UB 914 x 419 x 343	343,3	625800	13730	15480	37,83	191,1	39160	1871	2890	9,46	111,6	1199	75650	1	1	1	3	4	4	✓	HI	HI
UB 914 x 419 x 388	388,0	719600	15630	17670	38,16	211,9	45440	2161	3341	9,59	122,8	1741	88690	1	1	1	2	4	4	✓	HI	HI
UB 1016 x 305 x 222	222	407700	8405	9803	37,97	172,2	9546	636,4	1020	5,81	93,35	406,0	21370	1	1	-	4	4	-	✓	✓	✓
UB 1016 x 305 x 249	249	481100	9818	11350	38,97	180,7	11750	783,6	1245	6,09	103,6	584,4	26620	1	1	2	4	4	4	✓	HI	HI
UB 1016 x 305 x 272	272	553800	11190	12820	39,96	184,6	14000	933,6	1470	6,35	113,6	822,4	32070	1	1	2	4	4	4	✓	HI	HI
UB 1016 x 305 x 314	314	644200	12880	14850	40,11	213,4	16230	1082	1713	6,37	126,0	1252	37540	1	1	1	4	4	4	✓	HI	HI
UB 1016 x 305 x 350	350	723000	14340	16590	40,30	236,0	18460	1223	1941	6,44	136,2	1707	43020	1	1	1	3	4	4	✓	HI	HI
UB 1016 x 305 x 393	393	807700	15900	18540	40,18	271,3	20500	1353	2168	6,40	147,3	2332	48080	1	1	1	2	4	4	✓	HI	
UB 1016 x 305 x 415	415	853100	16730	19570	40,17	288,6	21710	1428	2298	6,41	153,1	2713	51080	1	1	1	2	3	4	✓	HI	
UB 1016 x 305 x 438	438	909200	17720	20750	40,43	299,9	23360	1531	2463	6,48	160,0	3190	55290	1	1	1	1	3	4	✓	HI	
UB 1016 x 305 x 494	494	1028000	19840	23410	40,42	344,5	26820	1736	2818	6,53	174,1	4433	64010	1	1	1	1	2	3	✓	HI	
UB 1016 x 305 x 584	584	1246000	23600	28040	40,93	403,2	33430	2130	3475	6,70	199,1	7230	81240	1	1	1	1	1	2	✓	HI	

♦ W_{pl} : para el diseño plástico la sección debe pertenecer a la clase 1 o 2 según la capacidad de rotación que se precise. Véase pág. 203.
♦ W_{pl} : for plastic design, the shape must belong to class 1 or 2 according to the required rotation capacity. See page 203.
♦ W_{pl} : per il calcolo plastico, la sezione trasversale deve appartenere alla classe 1 o 2, conformemente alla capacità di rotazione richiesta. Vedere pagina 203.

Perfiles I británicos de alas inclinadas

Dimensiones: BS 4-1: 2005
Tolerancias: EN 10024: 1995
Estado de la superficie: conforme a norma EN 10163-3: 2004, clase C, subclase 1

British joists with taper flanges

Dimensions: BS 4-1: 2005
Tolerances: EN 10024: 1995
Surface condition: according to EN 10163-3: 2004, class C, subclass 1

Profili I ad ali inclinate

Dimensioni: BS 4-1: 2005
Tolleranze: EN 10024: 1995
Condizioni di superficie: secondo EN 10163-3: 2004, classe C, sottoclasse 1

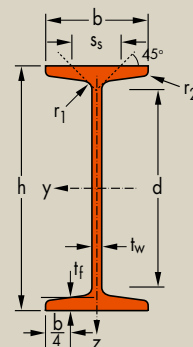

Denominación Designation Designazione	G kg/m	Dimensiones Dimensions Dimensioni							A mm ² x10 ²	Superficie Surface Superficie	
		h mm	b mm	t _w mm	t _f mm	r ₁ mm	r ₂ mm	d mm		A _L m ² /m	A _C m ² /t
J 76 x 76 x 13*	12,8	76,2	76,2	5,1	8,4	9,4	4,70	39	16,07	0,430	34,12
J 76 x 76 x 15*	15,0	76,2	80,0	8,9	8,4	9,4	4,70	39	18,82	0,440	29,65
J 89 x 89 x 19*	19,5	88,9	88,9	9,5	9,9	11,1	5,55	45	24,36	0,500	25,92
J 102 x 44 x 7*	7,5	101,6	44,5	4,3	6,1	6,9	3,45	75	9,41	0,360	49,11
J 102 x 102 x 23*	23,0	101,6	101,6	9,5	10,3	11,1	5,55	57	28,76	0,570	25,22
J 114 x 114 x 27*	26,9	114,3	114,3	9,5	10,7	15,2	7,60	60	33,89	0,640	24,14
J 127 x 76 x 16*	16,5	127,0	76,2	5,6	9,6	9,4	4,70	87	20,89	0,530	32,39
J 127 x 114 x 27*	26,9	127,0	114,3	7,4	11,4	9,9	4,95	81	33,82	0,670	25,32
J 127 x 114 x 29*	29,3	127,0	114,3	10,2	11,5	9,9	4,95	81	36,80	0,670	23,10
J 152 x 127 x 37*	37,3	152,4	127,0	10,4	13,2	13,5	6,75	96	46,87	0,770	20,80
J 203 x 152 x 52*	52,3	203,2	152,4	8,9	16,5	15,5	7,75	135	65,93	0,970	18,65
J 254 x 114 x 37*	37,2	254,0	114,3	7,6	12,8	12,4	6,20	200	46,94	0,930	25,12
J 254 x 203 x 82*	82,0	254,0	203,2	10,2	19,9	21,4	10,70	166	103,9	1,260	15,40

* Tonelaje mínimo y condiciones de suministro previo acuerdo.

* Minimum tonnage and delivery conditions upon agreement.

* Tonnellaggio minimo e condizioni di fornitura da concordare.

Denominación Designation Designazione	Propiedades de perfil / Section properties / Proprietà geometriche del profilo												Classification EN 1993-1-1: 2005				EN 10025-2: 2004	EN 10025-4: 2004	EN 10225:2001	
	eje fuerte y-y strong axis y-y asse forte y-y						eje débil z-z weak axis z-z asse debole z-z						Pure bending y-y		Pure compression					
	G kg/m	I_y mm ⁴ x10 ⁴	$W_{el,y}$ mm ³ x10 ³	$W_{pl,y} \blacklozenge$ mm ³ x10 ³	i_y mm x10	A_z mm ² x10 ²	I_z mm ⁴ x10 ⁴	$W_{el,z}$ mm ³ x10 ³	$W_{pl,z} \blacklozenge$ mm ³ x10 ³	i_z mm x10	s_s mm	I_t mm ⁴ x10 ⁴	I_w mm ⁶ x10 ⁹	S235	S355	S235				S355
J 76 x 76 x 13	12,8	158	41,4	48,1	3,13	5,65	52,5	13,8	22,7	1,81	34,5	4,39	0,62	1	1	1	1	✓		
J 76 x 76 x 15	15,0	171	44,8	53,1	3,01	8,12	60,8	15,2	25,6	1,80	38,1	7,73	0,71	1	1	1	1	✓		
J 89 x 89 x 19	19,5	303	68,1	80,8	3,52	10,43	98,9	22,2	37,4	2,01	43,7	12,7	1,58	1	1	1	1	✓		
J 102 x 44 x 7	7,5	152	29,9	35,0	4,02	5,24	7,82	3,52	6,04	0,91	25,0	1,29	0,18	1	1	1	1	✓		
J 102 x 102 x 23	23,0	479	94,3	111	4,08	11,71	152	29,9	50,1	2,30	45,2	14,9	3,23	1	1	1	1	✓		
J 114 x 114 x 27	26,9	729	128	148	4,64	14,68	218	38,1	65,0	2,54	50,6	21,2	6,06	1	1	1	1	✓		
J 127 x 76 x 16	16,5	568	89,5	103	5,22	8,95	61,5	16,1	26,7	1,72	37,3	6,44	2,17	1	1	1	1	✓		
J 127 x 114 x 27	26,9	940	148	169	5,27	11,46	240	42,0	69,0	2,67	45,1	15,8	8,13	1	1	1	1	✓		
J 127 x 114 x 29	29,3	968	152	177	5,13	14,59	243	42,6	70,8	2,57	47,8	20,6	8,21	1	1	1	1	✓		
J 152 x 127 x 37	37,3	1802	237	274	6,20	19,20	382	60,1	100	2,85	55,5	33,6	18,9	1	1	1	1	✓		
J 203 x 152 x 52	52,3	4772	470	534	8,51	23,41	831	109	179	3,55	64,1	60,2	73,8	1	1	1	1	✓		
J 254 x 114 x 37	37,2	5042	397	454	10,36	22,54	273	47,8	80,0	2,41	50,5	23,9	40,6	1	1	1	1	✓		
J 254 x 203 x 82	82,0	12010	946	1066	10,75	35,84	2326	229	378	4,73	80,4	142	326	1	1	1	1	✓		

- ◆ W_{pl} : para el diseño plástico la sección debe pertenecer a la clase 1 o 2 según la capacidad de rotación que se precise. Véase pág. 203.
- ◆ W_{pl} : for plastic design, the shape must belong to class 1 or 2 according to the required rotation capacity. See page 203.
- ◆ W_{pl} : per il calcolo plastico, la sezione trasversale deve appartenere alla classe 1 o 2, conformemente alla capacità di rotazione richiesta. Vedere pagina 203.

Perfiles H británicos de alas anchas y caras paralelas para pilares

Dimensiones: BS 4-1: 2005
Tolerancias: EN 10034: 1993
Estado de la superficie: conforme a norma EN 10163-3: 2004, clase C, subclase 1

British universal columns

Dimensions: BS 4-1: 2005
Tolerances: EN 10034: 1993
Surface condition: according to EN 10163-3: 2004, class C, subclass 1

Profili H portanti

Dimensioni: BS 4-1: 2005
Tolleranze: EN 10034: 1993
Condizioni di superficie: secondo EN 10163-3: 2004, classe C, sottoclasse 1

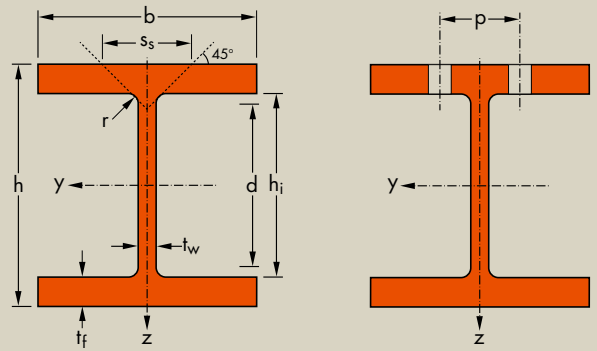

Denominación Designation Designazione	G kg/m	Dimensiones Dimensions Dimensioni					A mm ² x10 ²	Dimensiones de construcción Dimensions for detailing Dimensioni di dettaglio					Superficie Surface Superficie	
		h mm	b mm	t _w mm	t _f mm	r mm		h _i mm	d mm	Ø	p _{min} mm	p _{max} mm	A _L m ² /m	A _C m ² /t
UC 152 x 152 x 23*	23,0	152,4	152,2	5,8	6,8	7,6	29,25	138,8	123,6	M20	72	76	0,889	38,72
UC 152 x 152 x 30*	30,0	157,6	152,9	6,5	9,4	7,6	38,26	138,8	123,6	M20	72	76	0,901	29,99
UC 152 x 152 x 37*	37,0	161,8	154,4	8,0	11,5	7,6	47,11	138,8	123,6	M20	74	78	0,912	24,66
UC 203 x 203 x 46*	46,1	203,2	203,6	7,2	11,0	10,2	58,73	181,2	160,8	M27	90	104	1,189	25,79
UC 203 x 203 x 52*	52,0	206,2	204,3	7,9	12,5	10,2	66,28	181,2	160,8	M27	90	104	1,196	22,99
UC 203 x 203 x 60*	60,0	209,6	205,8	9,4	14,2	10,2	76,37	181,2	160,8	M27	90	106	1,206	20,12
UC 203 x 203 x 71*	71,0	215,8	206,4	10,0	17,3	10,2	90,43	181,2	160,8	M27	92	106	1,220	17,18
UC 203 x 203 x 86*	86,1	222,2	209,1	12,7	20,5	10,2	109,6	181,2	160,8	M27	94	110	1,238	14,38
UC 254 x 254 x 73*	73,1	254,1	254,6	8,6	14,2	12,7	93,10	225,7	200,3	M27	100	152	1,488	20,35
UC 254 x 254 x 89*	88,9	260,3	256,3	10,3	17,3	12,7	113,3	225,7	200,3	M27	102	154	1,503	16,90
UC 254 x 254 x 107*	107,1	266,7	258,8	12,8	20,5	12,7	136,4	225,7	200,3	M27	104	156	1,521	14,21
UC 254 x 254 x 132*	132,0	276,3	261,3	15,3	25,3	12,7	168,1	225,7	200,3	M27	108	160	1,545	11,71
UC 254 x 254 x 167*	167,1	289,1	265,2	19,2	31,7	12,7	212,9	225,7	200,3	M27	112	164	1,579	9,449
UC 305 x 305 x 97*	96,9	307,9	305,3	9,9	15,4	15,2	123,4	277,1	246,7	M27	102	204	1,791	18,48
UC 305 x 305 x 118*	117,9	314,5	307,4	12,0	18,7	15,2	150,2	277,1	246,7	M27	104	206	1,809	15,34
UC 305 x 305 x 137*	136,9	320,5	309,2	13,8	21,7	15,2	174,4	277,1	246,7	M27	106	208	1,824	13,32
UC 305 x 305 x 158*	158,1	327,1	311,2	15,8	25,0	15,2	201,4	277,1	246,7	M27	108	210	1,841	11,65
UC 305 x 305 x 198*	198,1	339,9	314,5	19,1	31,4	15,2	252,4	277,1	246,7	M27	112	212	1,874	9,455
UC 305 x 305 x 240*	240,0	352,5	318,4	23,0	37,7	15,2	305,8	277,1	246,7	M27	116	216	1,907	7,942
UC 305 x 305 x 283*	282,9	365,3	322,2	26,8	44,1	15,2	360,4	277,1	246,7	M27	120	218	1,940	6,856
UC 356 x 368 x 129*	129,0	355,6	368,6	10,4	17,5	15,2	164,3	320,6	290,2	M27	98	262	2,139	16,58
UC 356 x 368 x 153*	152,9	362,0	370,5	12,3	20,7	15,2	194,8	320,6	290,2	M27	100	264	2,155	14,09
UC 356 x 368 x 177*	177,0	368,2	372,6	14,4	23,8	15,2	225,5	320,6	290,2	M27	102	266	2,172	12,27
UC 356 x 368 x 202*	201,9	374,6	374,7	16,5	27,0	15,2	257,2	320,6	290,2	M27	104	268	2,189	10,84
UC 356 x 406 x 235*	235,1	381,0	394,8	18,4	30,2	15,2	299,0	320,6	290,2	M27	106	288	2,278	9,693
UC 356 x 406 x 287*	287,1	393,6	399,0	22,6	36,5	15,2	365,7	320,6	290,2	M27	112	294	2,312	8,053
UC 356 x 406 x 340*	339,9	406,4	403,0	26,6	42,9	15,2	433,0	320,6	290,2	M27	118	292	2,346	6,900
UC 356 x 406 x 393*	393,0	419,0	407,0	30,6	49,2	15,2	500,6	320,6	290,2	M27	122	296	2,379	6,053
UC 356 x 406 x 467*	467,0	436,6	412,2	35,8	58,0	15,2	594,9	320,6	290,2	M27	128	300	2,424	5,191
UC 356 x 406 x 551*	551,0	455,6	418,5	42,1	67,5	15,2	701,9	320,6	290,2	M27	134	306	2,475	4,492
UC 356 x 406 x 634*	633,9	474,6	424,0	47,6	77,0	15,2	807,5	320,6	290,2	M27	140	312	2,524	3,981

+ Pedido mínimo: 40 t por perfil y calidad o según acuerdo.
* Tonelaje mínimo y condiciones de suministro previo acuerdo.

+ Minimum order: 40t per section and grade or upon agreement.
* Minimum tonnage and delivery conditions upon agreement.

+ Ordine minimo: 40t per sezione e qualità o da concordare.
* Tonnellaggio minimo e condizioni di fornitura da concordare.

Denominación Designation Designazione	Propiedades de perfil / Section properties / Proprietà geometriche del profilo												Classification EN 1993-1-1: 2005						EN 10025-2: 2004	EN 10025-4: 2004	EN 10225:2001	
	G kg/m	eje fuerte y-y strong axis y-y asse forte y-y					eje débil z-z weak axis z-z asse debole z-z					Pure bending y-y			Pure compression							
		I_y mm ⁴ x10 ⁴	W_{ely} mm ³ x10 ³	W_{ply} ♦ mm ³ x10 ³	i_y mm x10	A_{vz} mm ² x10 ²	I_z mm ⁴ x10 ⁴	W_{elz} mm ³ x10 ³	W_{plz} ♦ mm ³ x10 ³	i_z mm x10	s_s mm	I_t mm ⁴ x10 ⁴	I_w mm ⁶ x10 ⁹	S235	S355	S460	S235	S355				S460
UC 152 x 152 x 23	23,0	1250	164,0	182,0	6,54	9,97	399,9	52,55	80,16	3,70	28,3	4,86	21,18	2	3	3	2	3	3	✓	✓	✓
UC 152 x 152 x 30	30,0	1748	221,8	247,7	6,76	11,56	560,5	73,31	111,6	3,83	34,2	10,67	30,75	1	1	2	1	1	2	✓	✓	✓
UC 152 x 152 x 37	37,0	2210	273,2	308,8	6,85	14,27	706,2	91,48	139,6	3,87	39,9	19,49	39,84	1	1	1	1	1	1	✓	✓	✓
UC 203 x 203 x 46	46,1	4568	449,6	497,4	8,82	16,98	1548	152,1	230,9	5,13	41,2	22,34	142,9	1	2	3	1	2	3	✓	✓	✓
UC 203 x 203 x 52	52,0	5259	510,1	567,4	8,91	18,75	1778	174,0	264,2	5,18	44,9	31,97	166,6	1	1	2	1	1	2	✓	✓	✓
UC 203 x 203 x 60	60,0	6125	584,4	656,1	8,96	22,16	2065	200,6	305,3	5,20	49,8	47,78	196,9	1	1	1	1	1	1	✓	✓	✓
UC 203 x 203 x 71	71,0	7618	706,0	798,8	9,18	24,27	2537	245,9	373,7	5,30	56,6	80,63	249,7	1	1	1	1	1	1	✓	✓	✓
UC 203 x 203 x 86	86,1	9449	850,5	976,7	9,28	30,69	3127	299,1	456,2	5,34	65,7	138,3	317,7	1	1	1	1	1	1	✓	✓	✓
UC 254 x 254 x 73	73,1	11410	897,9	992,1	11,07	25,62	3908	307,0	465,4	6,48	51,9	57,74	562,0	1	2	3	1	2	3	✓	HI	HI
UC 254 x 254 x 89	88,9	14270	1096	1224	11,22	30,81	4857	379,0	575,3	6,55	59,8	102,7	716,6	1	1	1	1	1	1	✓	HI	HI
UC 254 x 254 x 107	107,1	17510	1313	1484	11,33	38,11	5928	458,1	697,0	6,59	68,7	173,9	897,5	1	1	1	1	1	1	✓	HI	HI
UC 254 x 254 x 132	132,0	22530	1631	1869	11,58	46,21	7531	576,4	878,4	6,69	80,8	321,5	1185	1	1	1	1	1	1	✓	HI	HI
UC 254 x 254 x 167	167,1	30000	2075	2424	11,87	58,86	9870	744,3	1137	6,81	97,5	633,8	1632	1	1	1	1	1	1	✓	HI	HI
UC 305 x 305 x 97	96,9	22250	1445	1592	13,42	35,62	7308	478,7	726,1	7,69	58,5	91,80	1562	1	3	3	1	3	3	✓	HI	HI
UC 305 x 305 x 118	117,9	27670	1760	1958	13,57	43,16	9059	589,4	895,4	7,77	67,2	162,3	1980	1	1	2	1	1	2	✓	HI	HI
UC 305 x 305 x 137	136,9	32810	2048	2297	13,72	49,81	10700	692,1	1053	7,83	75,0	251,1	2386	1	1	1	1	1	1	✓	HI	HI
UC 305 x 305 x 158	158,1	38750	2369	2680	13,87	57,32	12570	807,8	1230	7,90	83,6	381,6	2865	1	1	1	1	1	1	✓	HI	HI
UC 305 x 305 x 198	198,1	50900	2995	3440	14,20	70,45	16300	1037	1581	8,04	99,7	741,2	3873	1	1	1	1	1	1	✓	HI	HI
UC 305 x 305 x 240	240,0	64200	3643	4247	14,49	85,85	20310	1276	1951	8,15	116,2	1287	5025	1	1	1	1	1	1	✓	HI	HI
UC 305 x 305 x 283	282,9	78870	4318	5105	14,79	101,5	24630	1529	2342	8,27	132,8	2062	6341	1	1	1	1	1	1	✓	HI	
UC 356 x 368 x 129	129,0	40250	2264	2479	15,65	42,47	14610	792,8	1199	9,43	63,2	152,7	4174	2	3	3	2	3	3	✓	HI	HI
UC 356 x 368 x 153	152,9	48590	2684	2965	15,79	50,26	17550	947,5	1435	9,49	71,5	251,2	5110	1	2	3	1	2	3	✓	HI	HI
UC 356 x 368 x 177	177,0	57120	3103	3455	15,91	58,81	20530	1102	1671	9,54	79,8	383,5	6084	1	1	2	1	1	2	✓	HI	HI
UC 356 x 368 x 202	201,9	66260	3538	3972	16,05	67,55	23690	1264	1920	9,60	88,3	561,4	7151	1	1	1	1	1	1	✓	HI	HI
UC 356 x 406 x 235	235,1	79080	4151	4687	16,25	75,71	30990	1570	2383	10,20	96,6	817,7	9529	1	1	1	1	1	1	✓	HI	HI
UC 356 x 406 x 287	287,1	99880	5075	5812	16,53	93,78	38680	1939	2949	10,28	113,4	1455	12320	1	1	1	1	1	1	✓	HI	HI
UC 356 x 406 x 340	339,9	122500	6031	6999	16,82	111,7	46850	2325	3544	10,40	130,2	2370	15460	1	1	1	1	1	1	✓	HI	
UC 356 x 406 x 393	393,0	146600	6998	8222	17,11	130,1	55370	2721	4154	10,52	146,8	3592	18900	1	1	1	1	1	1	✓	HI	
UC 356 x 406 x 467	467,0	183000	8383	10000	17,54	155,2	67830	3291	5034	10,68	169,6	5896	24260	1	1	1	1	1	1	✓	HI	
UC 356 x 406 x 551	551,0	226900	9962	12080	17,98	185,9	82670	3951	6058	10,85	194,9	9402	31050	1	1	1	1	1	1	✓	HI	
UC 356 x 406 x 634	633,9	274800	11580	14240	18,45	214,6	98130	4629	7108	11,02	219,4	13990	38660	1	1	1	1	1	1	✓	HI	

HI = HSTAR®

- ♦ W_{pl} : para el diseño plástico la sección debe pertenecer a la clase 1 o 2 según la capacidad de rotación que se precise. Véase pág. 203.
- ♦ W_{pl} : for plastic design, the shape must belong to class 1 or 2 according to the required rotation capacity. See page 203.
- ♦ W_{pl} : per il calcolo plastico, la sezione trasversale deve appartenere alla classe 1 o 2, conformemente alla capacità di rotazione richiesta. Vedere pagina 203.

Perfiles H británicos de alas anchas y caras paralelas para pilotes

Dimensiones: BS 4-1: 2005
Tolerancias: EN 10034: 1993
Estado de la superficie: conforme a norma EN 10163-3: 2004, clase C, subclase 1

British universal bearing piles with wide flanges

Dimensions: BS 4-1: 2005
Tolerances: EN 10034: 1993
Surface condition: according to EN 10163-3: 2004, class C, subclass 1

Profili H portanti ad ali larghe

Dimensioni: BS 4-1: 2005
Tolleranze: EN 10034: 1993
Condizioni di superficie: secondo EN 10163-3: 2004, classe C, sottoclasse 1

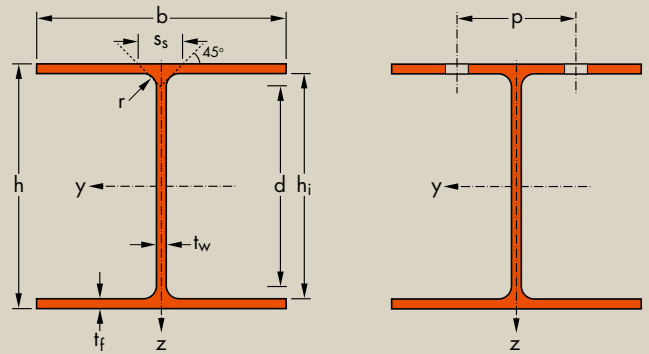

Denominación Designation Designazione	Dimensiones Dimensions Dimensioni						A mm ² x10 ²	Dimensiones de construcción Dimensions for detailing Dimensioni di dettaglio					Superficie Surface Superficie	
	G kg/m	h mm	b mm	t _w mm	t _f mm	r mm		h _i mm	d mm	Ø	p _{min} mm	p _{max} mm	A _L m ² /m	A _G m ² /t
UBP 203 x 203 x 45*	44,9	200,2	205,9	9,50	9,50	10,2	57,23	181,2	160,8	M27	90	106	1,187	26,43
UBP 203 x 203 x 54*	53,9	204	207,7	11,30	11,40	10,2	68,72	181,2	160,8	M27	94	108	1,199	22,22
UBP 254 x 254 x 63*	63,0	247,1	256,6	10,60	10,70	12,7	80,22	225,7	200,3	M27	102	154	1,478	23,46
UBP 254 x 254 x 71*	71,0	249,7	258	12,00	12,00	12,7	90,39	225,7	200,3	M27	104	156	1,486	20,94
UBP 254 x 254 x 85*	85,1	254,3	260,4	14,40	14,30	12,7	108,4	225,7	200,3	M27	106	158	1,500	17,63
UBP 305 x 305 x 79*	78,9	299,3	306,4	11,00	11,10	15,2	100,5	277,1	246,7	M27	102	204	1,776	22,52
UBP 305 x 305 x 88*	88,0	301,7	307,8	12,40	12,30	15,2	112,1	277,1	246,7	M27	104	206	1,784	20,28
UBP 305 x 305 x 95*	94,9	303,7	308,7	13,30	13,30	15,2	120,9	277,1	246,7	M27	106	206	1,790	18,85
UBP 305 x 305 x 110*	110,0	307,9	310,7	15,30	15,40	15,2	140,1	277,1	246,7	M27	108	208	1,802	16,39
UBP 305 x 305 x 126*	126,1	312,3	312,9	17,50	17,60	15,2	160,6	277,1	246,7	M27	110	210	1,815	14,40
UBP 305 x 305 x 149*	149,1	318,5	316	20,60	20,70	15,2	189,9	277,1	246,7	M27	114	214	1,834	12,30
UBP 305 x 305 x 186*	186,0	328,3	320,9	25,50	25,60	15,2	236,9	277,1	246,7	M27	118	218	1,863	10,02
UBP 305 x 305 x 223*	222,9	337,9	325,7	30,30	30,40	15,2	284,0	277,1	246,7	M27	124	220	1,892	8,487
UBP 356 x 368 x 109*	108,9	346,4	371	12,80	12,90	15,2	138,7	320,6	290,2	M27	102	266	2,125	19,51
UBP 356 x 368 x 133*	133,0	352	373,8	15,60	15,70	15,2	169,4	320,6	290,2	M27	104	268	2,142	16,11
UBP 356 x 368 x 152*	152,0	356,4	376	17,80	17,90	15,2	193,7	320,6	290,2	M27	106	270	2,155	14,18
UBP 356 x 368 x 174*	173,9	361,4	378,5	20,30	20,40	15,2	221,5	320,6	290,2	M27	110	272	2,170	12,48

* Tonelaje mínimo y condiciones de suministro previo acuerdo.

* Minimum tonnage and delivery conditions upon agreement.

* Tonnellaggio minimo e condizioni di fornitura da concordare.

Páginas de notaciones 199-203 / Notations pages 199-203 / Pagine di annotazioni 199-203

Denominación Designation Designazione	Propiedades de perfil / Section properties / Proprietà geometriche del profilo												Classification EN 1993-1-1: 2005						EN 10025-2: 2004	EN 10025-4: 2004	EN 10225:2001	
	G kg/m	eje fuerte y-y strong axis y-y asse forte y-y					eje débil z-z weak axis z-z asse debole z-z					Pure bending y-y			Pure compression							
		I_y mm ⁴ x10 ⁴	W_{ely} mm ³ x10 ³	W_{ply} ♦ mm ³ x10 ³	i_y mm x10	A_z mm ² x10 ²	I_z mm ⁴ x10 ⁴	W_{elz} mm ³ x10 ³	W_{plz} ♦ mm ³ x10 ³	i_z mm x10	s_s mm	I_t mm ⁴ x10 ⁴	I_w mm ⁶ x10 ⁹	S235	S355	S460	S235	S355				S460
UBP 203 x 203 x 45	44,9	4100	409,6	458,9	8,46	20,95	1384	134,4	206,1	4,92	40,45	20,80	125,7	2	3	-	2	3	-	✓		
UBP 203 x 203 x 54	53,9	5027	492,8	556,7	8,55	24,98	1705	164,2	252,4	4,98	46,05	34,97	157,9	1	2	-	1	2	-	✓		
UBP 254 x 254 x 63	63,0	8860	717,2	799,3	10,51	29,16	3016	235,1	359,7	6,13	46,88	37,20	421,0	3	3	4	3	3	4	✓		
UBP 254 x 254 x 71	71,0	10070	806,7	904,0	10,56	32,96	3439	266,6	408,7	6,17	50,88	52,27	485,2	2	3	3	2	3	3	✓		
UBP 254 x 254 x 85	85,1	12280	966,1	1092	10,65	39,58	4215	323,8	497,9	6,24	57,88	87,82	606,0	1	2	3	1	2	3	✓	HI	HI
UBP 305 x 305 x 79	78,9	16440	1099	1218	12,79	37,06	5326	347,7	531,2	7,28	51,01	51,37	1105	3	4	4	3	4	4	✓	✓	✓
UBP 305 x 305 x 88	88,0	18420	1221	1360	12,82	41,61	5984	388,9	595,2	7,31	54,81	70,05	1252	3	3	4	3	3	4	✓	✓	✓
UBP 305 x 305 x 95	94,9	20040	1320	1474	12,87	44,65	6529	423,0	648,0	7,35	57,71	86,69	1375	2	3	3	2	3	3	✓	✓	✓
UBP 305 x 305 x 110	110,0	23560	1531	1720	12,97	51,42	7709	496,2	761,7	7,42	63,91	131,4	1647	1	3	3	1	3	3	✓	HI	HI
UBP 305 x 305 x 126	126,1	27410	1755	1986	13,06	58,91	9002	575,4	885,2	7,49	70,51	194,3	1951	1	2	3	1	2	3	✓	HI	HI
UBP 305 x 305 x 149	149,1	33070	2076	2370	13,20	69,62	10910	690,5	1066	7,58	79,81	314,2	2414	1	1	1	1	1	1	✓	HI	HI
UBP 305 x 305 x 186	186,0	42610	2596	3003	13,41	86,95	14140	881,5	1366	7,73	94,51	593,7	3230	1	1	1	1	1	1	✓	HI	HI
UBP 305 x 305 x 223	222,9	52700	3119	3653	13,62	104,4	17580	1079	1680	7,87	108,9	998,4	4138	1	1	1	1	1	1	✓	HI	HI
UBP 356 x 368 x 109	108,9	30630	1769	1956	14,86	48,59	10990	592,3	902,9	8,90	56,41	90,73	3053	3	4	4	3	4	4	✓	✓	✓
UBP 356 x 368 x 133	133,0	37980	2158	2406	14,98	59,22	13680	731,9	1119	8,99	64,81	160,7	3864	3	3	4	3	3	4	✓	HI	HI
UBP 356 x 368 x 152	152,0	43970	2468	2767	15,07	67,68	15880	844,5	1293	9,05	71,41	236,4	4543	2	3	3	2	3	3	✓	HI	HI
UBP 356 x 368 x 174	173,9	51010	2823	3186	15,18	77,41	18460	975,6	1497	9,13	78,91	348,5	5360	1	2	3	1	2	3	✓	HI	HI

HI = HSTAR®

♦ W_{pl} : para el diseño plástico la sección debe pertenecer a la clase 1 o 2 según la capacidad de rotación que se precise. Véase pág. 203.

♦ W_{pl} : for plastic design, the shape must belong to class 1 or 2 according to the required rotation capacity. See page 203.

♦ W_{pl} : per il calcolo plastico, la sezione trasversale deve appartenere alla classe 1 o 2, conformemente alla capacità di rotazione richiesta. Vedere pagina 203.

Perfiles U británicos de alas paralelas

Dimensiones: BS 4-1: 2005
Tolerancias: EN 10279: 2000
Estado de la superficie: conforme a norma EN 10163-3: 2004, clase C, subclase 1

British parallel flange channels

Dimensions: BS 4-1: 2005
Tolerances: EN 10279: 2000
Surface condition: according to EN 10163-3: 2004, class C, subclass 1

Profili U ad ali paralele

Dimensioni: BS 4-1: 2005
Tolleranze: EN 10279: 2000
Condizioni di superficie: secondo EN 10163-3: 2004, classe C, sottoclasse 1

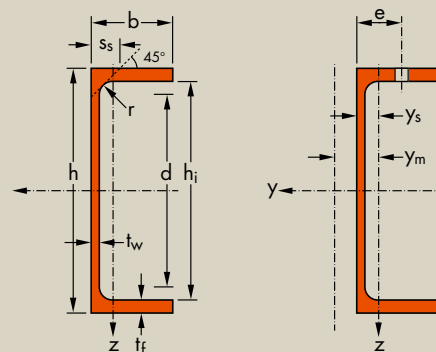

Denominación Designation Designazione	G kg/m	Dimensiones Dimensions Dimensioni					A mm ² x10 ²	Dimensiones de construcción Dimensions for detailing Dimensioni di dettaglio					Superficie Surface Superficie	
		h mm	b mm	t _w mm	t _r mm	r mm		h _i mm	d mm	Ø mm	e _{min} mm	e _{max} mm	A _L m ² /m	A _G m ² /t
PFC 100 x 50 x 10*	10,2	100	50	5,0	8,5	9	13,00	83	65	-	-	-	0,382	37,47
PFC 125 x 65 x 15*	14,8	125	65	5,5	9,5	12	18,80	106	82	M16	35,5	38	0,489	33,12
PFC 150 x 75 x 18*	17,9	150	75	5,5	10,0	12	22,77	130	106	M16	35,5	48	0,579	32,38
PFC 150 x 90 x 24*	23,9	150	90	6,5	12,0	12	30,41	126	102	M24	46,5	51	0,637	26,67
PFC 180 x 75 x 20*	20,3	180	75	6,0	10,5	12	25,91	159	135	M16	36	48	0,638	31,36
PFC 180 x 90 x 26*	26,1	180	90	6,5	12,5	12	33,19	155	131	M24	46,5	51	0,697	26,74
PFC 200 x 75 x 23*	23,4	200	75	6,0	12,5	12	29,87	175	151	M16	36	48	0,678	28,90
PFC 200 x 90 x 30*	29,7	200	90	7,0	14,0	12	37,86	172	148	M24	47	51	0,736	24,76
PFC 230 x 75 x 26*	25,7	230	75	6,5	12,5	12	32,69	205	181	M16	36,5	48	0,737	28,71
PFC 230 x 90 x 32*	32,2	230	90	7,5	14,0	12	40,97	202	178	M24	47,5	51	0,795	24,71
PFC 260 x 75 x 28*	27,6	260	75	7,0	12,0	12	35,14	236	212	M16	37	48	0,796	28,85
PFC 260 x 90 x 35*	34,8	260	90	8,0	14,0	12	44,38	232	208	M24	48	51	0,854	24,51
PFC 300 x 90 x 41*	41,4	300	90	9,0	15,5	12	52,73	269	245	M24	49	51	0,932	22,51
PFC 300 x 100 x 46*	45,5	300	100	9,0	16,5	15	58,00	267	237	M27	49	55	0,969	21,29
PFC 380 x 100 x 54*	54,0	380	100	9,5	17,5	15	68,74	345	315	M27	49,5	55	1,128	20,91
PFC 430 x 100 x 64*	64,4	430	100	11,0	19,0	15	82,09	392	362	M27	51	55	1,225	19,01

* Tonelaje mínimo y condiciones de suministro previo acuerdo.

* Minimum tonnage and delivery conditions upon agreement.

* Tonnellaggio minimo e condizioni di fornitura da concordare.

Páginas de notaciones 199-203 / Notations pages 199-203 / Pagine di annotazioni 199-203

Denominación Designation Designazione	Propiedades de perfil / Section properties / Proprietà geometriche del profilo														Classification EN 1993-1-1: 2005				EN 10025-2: 2004	EN 10025-4: 2004	EN 10225:2001		
	eje fuerte y-y strong axis y-y asse forte y-y						eje débil z-z weak axis z-z asse debole z-z					Pure bending y-y		Pure compression									
	G kg/m	I_y mm ⁴ x10 ⁴	W_{ely} mm ³ x10 ³	$W_{ply}◆$ mm ³ x10 ³	i_y mm x10	A_z mm ² x10 ²	I_z mm ⁴ x10 ⁴	W_{elz} mm ³ x10 ³	$W_{plz}◆$ mm ³ x10 ³	i_z mm x10	s_s mm	I_t mm ⁴ x10 ⁴	I_w mm ⁶ x10 ⁹	y_s mm x10	y_m mm x10	S235	S355	S235				S355	
PFC 100 x 50 x 10	10,2	207,7	41,54	48,87	4,00	5,69	32,30	9,89	18,24	1,58	18,8	2,53	0,44	1,73	3,48	1	1	1	1	✓			
PFC 125 x 65 x 15	14,8	483,1	77,29	89,88	5,07	8,11	80,02	18,82	34,33	2,06	22,0	4,72	1,74	2,25	4,61	1	1	1	1	✓			
PFC 150 x 75 x 18	17,9	861,0	114,8	132,1	6,15	9,52	131,0	26,61	48,31	2,40	22,5	6,10	4,24	2,58	5,37	1	1	1	1	✓			
PFC 150 x 90 x 24	23,9	1162	154,9	178,6	6,18	11,03	253,2	44,45	79,50	2,89	25,5	11,80	8,15	3,30	6,77	1	1	1	1	✓			
PFC 180 x 75 x 20	20,3	1370	152,2	176,2	7,27	12,05	146,4	28,76	52,95	2,38	23,5	7,34	6,92	2,41	5,05	1	1	1	1	✓			
PFC 180 x 90 x 26	26,1	1817	201,9	232,1	7,40	13,01	276,7	47,44	85,88	2,89	26,0	13,31	13,03	3,17	6,56	1	1	1	1	✓			
PFC 200 x 75 x 23	23,4	1963	196,3	227,0	8,11	13,37	170,0	33,84	62,23	2,39	25,5	11,09	9,89	2,48	5,16	1	1	1	1	✓			
PFC 200 x 90 x 30	29,7	2523	252,3	291,3	8,16	15,32	313,9	53,40	97,46	2,88	28,0	18,29	18,19	3,12	6,44	1	1	1	1	✓			
PFC 230 x 75 x 26	25,7	2748	239,0	278,4	9,17	16,26	181,0	34,81	64,11	2,35	26,0	11,82	14,16	2,30	4,82	1	1	1	2	✓			
PFC 230 x 90 x 32	32,2	3518	305,9	354,7	9,27	18,50	334,1	54,97	101,5	2,86	28,5	19,31	25,95	2,92	6,07	1	1	1	1	✓			
PFC 260 x 75 x 28	27,6	3619	278,4	327,8	10,15	19,42	185,5	34,36	61,24	2,30	26,0	11,73	19,03	2,10	4,43	1	1	1	2	✓			
PFC 260 x 90 x 35	34,8	4728	363,7	424,6	10,32	21,98	352,5	56,29	103,6	2,82	29,0	20,57	35,55	2,74	5,72	1	1	1	1	✓			
PFC 300 x 90 x 41	41,4	7218	481,2	567,8	11,70	28,08	403,9	63,12	113,7	2,77	31,5	28,77	54,80	2,60	5,39	1	1	1	2	✓			
PFC 300 x 100 x 46	45,5	8229	548,6	640,7	11,91	28,96	567,8	81,72	150,4	3,13	34,3	36,84	75,70	3,05	6,36	1	1	1	1	✓			
PFC 380 x 100 x 54	54,0	15030	791,3	933,4	14,79	38,03	643,0	89,18	158,2	3,06	35,8	45,66	141,8	2,79	5,86	1	1	2	3	✓			
PFC 430 x 100 x 64	64,4	21940	1020	1222	16,35	49,03	722,5	97,90	159,0	2,97	38,8	63,00	207,8	2,62	5,40	1	1	1	3	✓			

- W_{ply} se calcula según la hipótesis de un diagrama de tensiones birrectangular y sólo será aplicable cuando dos o más perfiles de sección en U estén combinados de tal manera que constituyan una sección doblemente simétrica, de tal modo que el momento de flexión que actúa en el plano del centro de gravedad no produzca torsión alguna.
- W_{ply} is determined assuming a bi-rectangular stress block distribution. Thus, the given value applies only if two or more channels are combined in such a way to form a double symmetric cross-section so that the bending moment acting in the plane of the centre of gravity will not lead to torsion.
- W_{ply} viene determinado presupponendo un diagramma delle sollecitazioni bi-rettangolare. Pertanto il valore dato vale unicamente se due o più sezioni ad U vengono combinate in modo tale da formare una sezione doppiamente simmetrica cosicché il momento flettente che agisce nel piano baricentrico non produce torsione.

Perfiles U británicos de alas inclinadas

Dimensiones: conforme a la anterior BS 4-1: 1993

Tolerancias: EN 10279: 2000

Estado de la superficie: conforme a norma EN 10163-3: 2004, clase C, subclase 1

British channels with taper flanges

Dimensions: In accordance with former BS 4-1: 1993

Tolerances: EN 10279: 2000

Surface condition: according to EN 10163-3: 2004, class C, subclass 1

Profili U ad ali inclinate

Dimensioni: sezione conforme a HD 4-1: 1993

Tolleranze: EN 10279: 2000

Condizioni di superficie: secondo EN 10163-3: 2004, classe C, sottoclasse 1

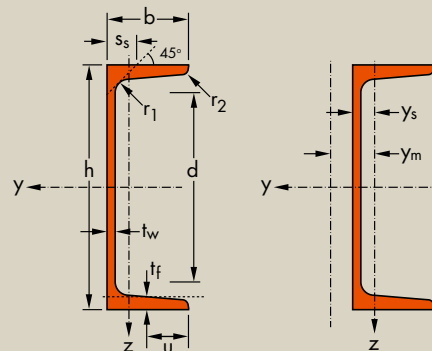

Denominación Designation Designazione	Dimensiones Dimensions Dimensioni								Superficie Surface Superficie		
	G kg/m	h mm	b mm	t _w mm	t _f mm	r ₁ mm	r ₂ mm	d mm	A mm ² x10 ²	A _L m ² /m	A _C m ² /t
CH 76 x 38 x 7*	6,7	76,2	38,1	5,1	6,8	12,0	6,0	38,2	8,62	0,29	42,52
CH 102 x 51 x 10*	10,4	101,6	50,8	6,1	7,6	12,0	6,0	61,2	13,16	0,39	37,33
CH 127 x 64 x 15*	14,9	127,0	63,5	6,4	9,2	13,0	6,5	80,5	18,79	0,48	32,85
CH 152 x 76 x 18*	17,9	152,4	76,2	6,4	9,0	14,0	7,0	103	22,48	0,58	33,10
CH 152 x 89 x 24*	23,9	152,4	88,9	7,1	11,6	16,0	8,0	93,7	30,02	0,63	26,80
CH 178 x 76 x 21*	20,8	177,8	76,2	6,6	10,3	16,0	8,0	123	26,39	0,63	30,62
CH 178 x 89 x 27*	26,8	177,8	88,9	7,6	12,3	17,0	8,5	116	33,79	0,68	25,68
CH 203 x 76 x 24*	23,9	203,2	76,2	7,1	11,2	17,0	8,5	144	30,28	0,69	28,77
CH 203 x 89 x 30*	29,8	203,2	88,9	8,1	12,9	17,5	8,75	139	37,60	0,73	24,77
CH 229 x 76 x 26*	26,1	228,6	76,2	7,6	11,2	17,5	8,75	169	33,14	0,74	28,21
CH 229 x 89 x 33*	32,7	228,6	88,9	8,6	13,3	19,0	9,5	161	41,43	0,78	24,00
CH 254 x 76 x 28*	28,2	254,0	76,2	8,1	10,9	19,0	9,5	192	35,94	0,78	27,77
CH 254 x 89 x 36*	35,7	254,0	88,9	9,1	13,6	20,4	10,2	183	45,35	0,83	23,32
CH 305 x 89 x 42*	41,8	304,8	88,9	10,2	13,7	25,7	12,85	227	53,00	0,93	22,50
CH 305 x 102 x 46*	46,2	304,8	101,6	10,2	14,8	26,7	13,35	222	58,10	0,99	21,62
CH 381 x 102 x 55*	55,0	381,0	101,6	10,4	16,3	28,2	14,1	292	69,55	1,14	20,84
CH 432 x 102 x 65*	65,5	431,8	101,6	12,2	16,8	24,0	12,0	350	82,37	1,24	19,13

* Tonelaje mínimo y condiciones de suministro previo acuerdo.

* Minimum tonnage and delivery conditions upon agreement.

* Tonnellaggio minimo e condizioni di fornitura da concordare.

Páginas de notaciones 199-203 / Notations pages 199-203 / Pagine di annotazioni 199-203

Denominación Designation Designazione	Propiedades de perfil / Section properties / Proprietà geometriche del profilo															Classification EN 1993-1-1: 2005				EN 10025-2: 2004	EN 10025-4: 2004	EN 10225:2001
	eje fuerte y-y strong axis y-y asse forte y-y						eje débil z-z weak axis z-z asse debole z-z					Pure bending y-y		Pure compression								
	G kg/m	I_y mm ⁴ x10 ⁴	W_{ely} mm ³ x10 ³	$W_{ply} \blacklozenge$ mm ³ x10 ³	i_y mm x10	A_z mm ² x10 ²	I_z mm ⁴ x10 ⁴	W_{elz} mm ³ x10 ³	$W_{plz} \blacklozenge$ mm ³ x10 ³	i_z mm x10	s_s mm	I_t mm ⁴ x10 ⁴	I_w mm ⁵ x10 ⁹	y_s mm x10	y_m mm x10	S235	S355	S235	S355			
CH 76 x 38 x 7	6,7	75,1	19,7	23,7	2,95	4,34	10,1	3,78	7,50	1,08	19,1	1,64	0,09	1,12	2,07	1	1	1	1	✓		
CH 102 x 51 x 10	10,4	206	40,5	48,7	3,95	6,62	27,7	7,64	14,9	1,45	21,3	2,89	0,44	1,42	2,71	1	1	1	1	✓		
CH 127 x 64 x 15	14,9	477	75,1	89,1	5,04	8,73	64,7	14,5	27,7	1,86	24,2	5,21	1,58	1,82	3,57	1	1	1	1	✓		
CH 152 x 76 x 18	17,9	838	110	129	6,11	10,5	109	20,0	38,3	2,21	25,0	6,24	3,95	2,04	4,12	1	1	1	1	✓		
CH 152 x 89 x 24	23,9	1154	151	177	6,20	11,9	210	34,5	63,7	2,64	29,8	12,9	7,21	2,67	5,34	1	1	1	1	✓		
CH 178 x 76 x 21	20,8	1329	150	176	7,10	12,8	129	23,6	45,3	2,21	27,5	8,87	6,39	2,05	4,14	1	1	1	1	✓		
CH 178 x 89 x 27	26,8	1735	195	229	7,17	14,7	234	37,7	70,9	2,63	31,5	15,8	11,1	2,58	5,16	1	1	1	1	✓		
CH 203 x 76 x 24	23,9	1948	192	227	8,02	15,6	146	26,3	50,8	2,20	29,4	11,5	9,55	2,00	4,02	1	1	1	1	✓		
CH 203 x 89 x 30	29,8	2469	243	286	8,10	17,7	256	40,6	77,2	2,61	32,8	18,8	16,1	2,48	4,98	1	1	1	1	✓		
CH 229 x 76 x 26	26,1	2608	228	272	8,87	18,5	152	26,7	51,7	2,14	30,1	12,8	13,0	1,87	3,76	1	1	1	1	✓		
CH 229 x 89 x 33	32,7	3364	294	349	9,01	21,1	274	42,5	81,9	2,57	34,4	22,0	22,4	2,37	4,75	1	1	1	1	✓		
CH 245 x 76 x 28	28,2	3361	265	319	9,67	21,8	153	26,1	51,2	2,06	31,0	14,4	16,9	1,73	3,44	1	1	1	1	✓		
CH 245 x 89 x 36	35,7	4435	349	416	9,89	24,7	289	44,1	85,2	2,53	35,9	25,6	30,0	2,27	4,52	1	1	1	1	✓		
CH 305 x 89 x 42	41,8	7036	462	572	11,5	33,7	304	44,5	92,9	2,40	39,6	39,9	57,2	2,10	4,19	1	1	1	1	✓		
CH 305 x 102 x 46	46,2	8078	530	652	11,8	34,2	472	61,7	128	2,85	41,6	49,5	86,3	2,56	5,25	1	1	1	1	✓		
CH 305 x 102 x 55	55,0	14730	773	952	14,6	43,2	546	70,3	145	2,80	44,1	62,8	157	2,43	4,99	1	1	1	2	✓		
CH 432 x 102 x 65	65,5	20970	971	1220	16,0	55,3	599	75,6	153	2,70	44,1	74,4	222	2,27	4,53	1	1	1	2	✓		

- W_{ply} se calcula según la hipótesis de un diagrama de tensiones birrectangular y sólo será aplicable cuando dos o más perfiles de sección en U estén combinados de tal manera que constituyan una sección doblemente simétrica, de tal modo que el momento de flexión que actúa en el plano del centro de gravedad no produzca torsión alguna.
- W_{ply} is determined assuming a bi-rectangular stress block distribution. Thus, the given value applies only if two or more channels are combined in such a way to form a double symmetric cross-section so that the bending moment acting in the plane of the centre of gravity will not lead to torsion.
- W_{ply} viene determinado presupponendo un diagramma delle sollecitazioni bi-rettangolare. Pertanto il valore dato vale unicamente se due o più sezioni ad U vengono combinate in modo tale da formare una sezione doppiamente simmetrica cosicché il momento flettente che agisce nel piano baricentrico non produce torsione.

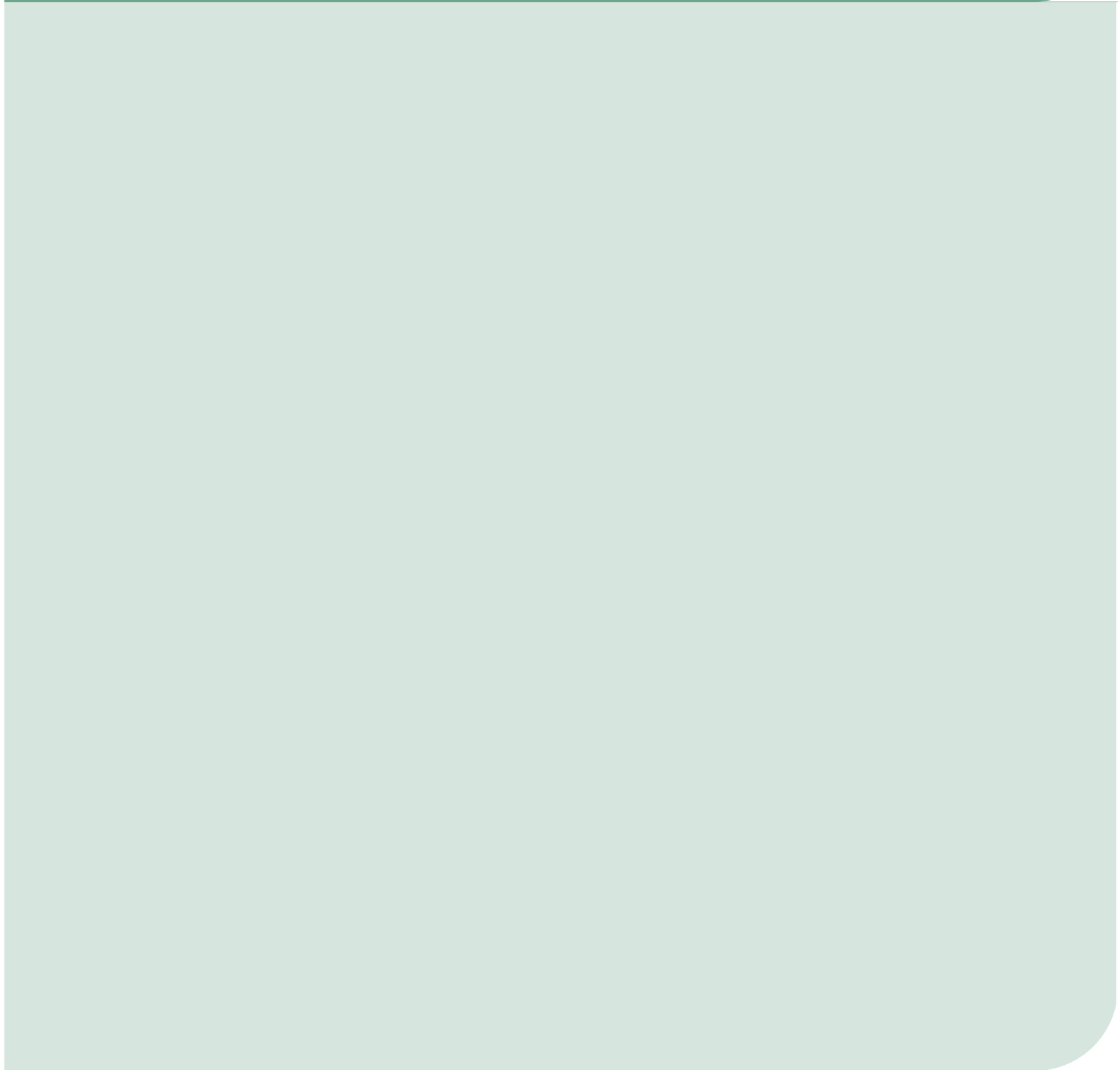

Perfiles americanos

- 116 W Perfiles americanos de alas paralelas
- 134 S Perfiles I americanos de alas inclinadas
- 136 HP Perfiles H americanos de alas anchas para pilotes
- 138 C Perfiles U americanos estándar de alas inclinadas
- 140 MC Perfiles U americanos de alas inclinadas
- 144 L Perfiles americanos angulares de lados iguales

American Sections

- 116 W American wide flange beams
- 134 S American standard beams
- 136 HP American wide flange bearing piles
- 138 C American standard channels
- 140 MC American channels
- 144 L American equal leg angles

Profili americani

- 116 W Profili I ad ali parallele
- 134 S Profili I ad ali inclinate
- 136 HP Profili H ad ali extra larghe
- 138 C Profili U standard ad ali inclinate
- 140 MC Profili U ad ali inclinate
- 144 L Angolari a lati uguali

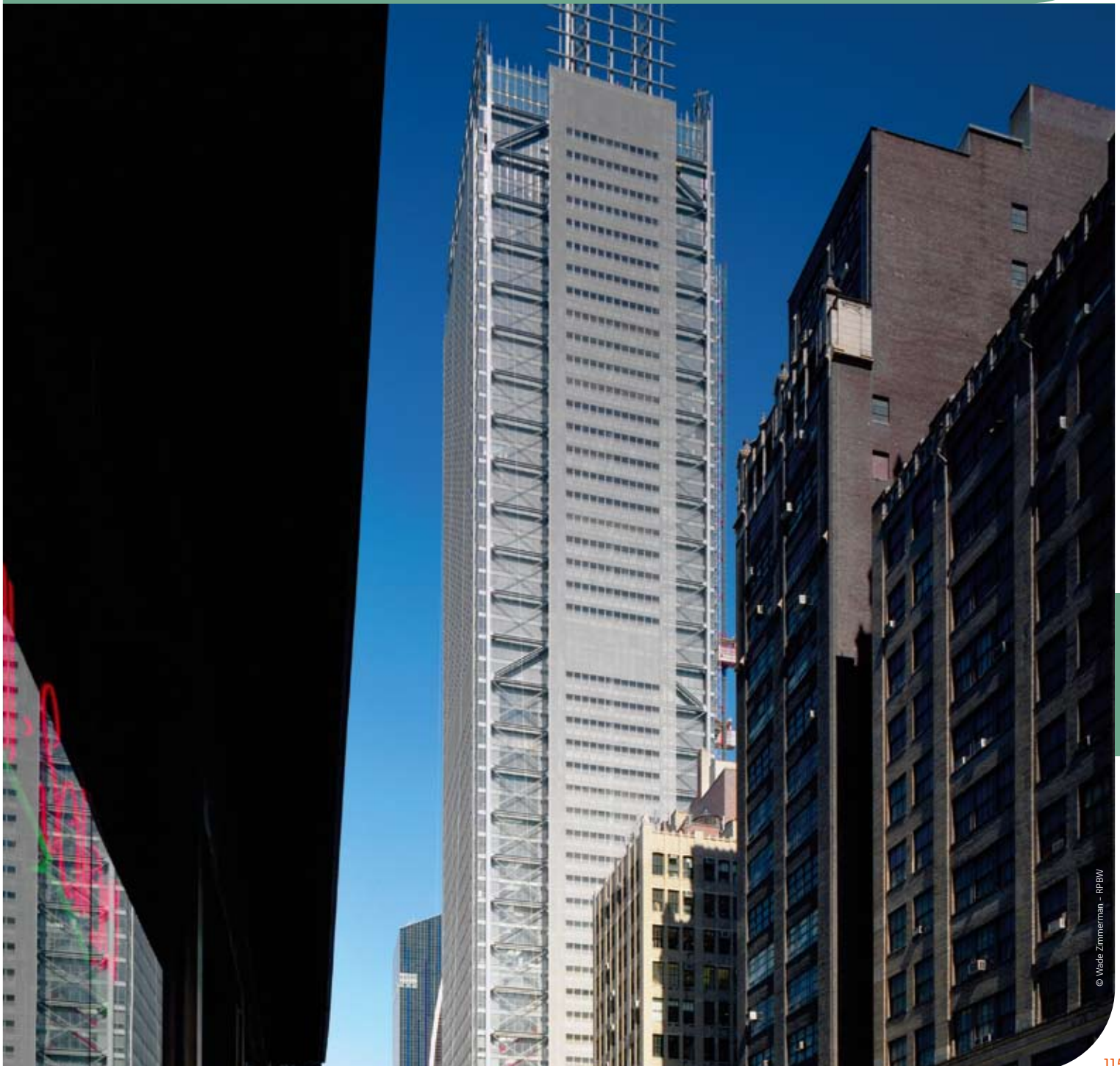

Perfiles americanos de alas paralelas

Dimensiones: ASTM A 6/A 6M - 07

Tolerancias: ASTM A 6/A 6M - 07

Estado de la superficie: conforme a ASTM A 6/A 6M - 07

American wide flange beams

Dimensions: ASTM A 6/A 6M - 07

Tolerances: ASTM A 6/A 6M - 07

Surface condition: according to ASTM A 6/A 6M - 07

Profili I ad ali parallele

Dimensioni: ASTM A 6/A 6M - 07

Tolleranze: ASTM A 6/A 6M - 07

Condizioni di superficie: conformi ad ASTM A 6/A 6M - 07

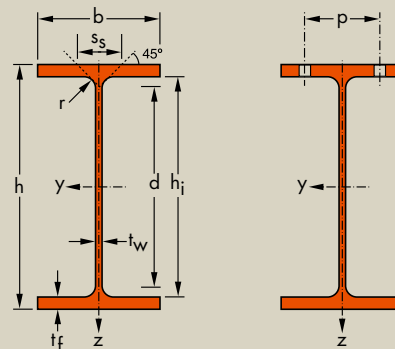

Denominación Designation Designazione (metric)	G kg/m	Dimensiones Dimensions Dimensioni					A mm ² x10 ²	Dimensiones de construcción Dimensions for detailing Dimensioni di dettaglio					Superficie Surface Superficie	
		h mm	b mm	t _w mm	t _f mm	r mm		h _i mm	d mm	Ø	p _{min} mm	p _{max} mm	A _L m ² /m	A _C m ² /t
W 100 x 100 x 19.3 ^{*†}	19,3	106	103	7,1	8,8	6	24,71	88,4	76,4	-	-	-	0,599	30,90
W 130 x 130 x 23.8 ^{*†}	23,8	127	127	6,1	9,1	8	30,30	108,8	92,8	M12	60	70	0,736	30,95
W 130 x 130 x 28.1 ^{*†}	28,1	131	128	6,9	10,9	8	35,99	109,2	93,2	M12	62	70	0,746	26,42
W 150 x 100 x 13.5 ^{*†}	13,5	150	100	4,3	5,5	6	17,29	139,0	127,0	-	-	-	0,681	50,19
W 150 x 100 x 18.0 ^{*†}	18,0	153	102	5,8	7,1	6	22,84	138,4	126,4	-	-	-	0,692	38,60
W 150 x 100 x 24.0 ^{*†}	24,0	160	102	6,6	10,3	6	30,52	139,4	127,4	-	-	-	0,704	29,40
W 150 x 150 x 22.5 ^{*†}	22,5	152	152	5,8	6,6	6	28,42	138,8	126,8	M16	70	82	0,890	39,89
W 150 x 150 x 29.8 ^{*†}	29,8	157	153	6,6	9,3	6	37,90	138,4	126,4	M16	72	84	0,902	30,33
W 150 x 150 x 37.1 ^{*†}	37,1	162	154	8,1	11,6	6	47,28	138,8	126,8	M16	74	84	0,913	24,61
W 200 x 100 x 15.0 ^{*†}	15,0	200	100	4,3	5,2	8	19,10	189,6	173,6	-	-	-	0,778	51,86
W 200 x 100 x 19.3 ^{*†}	19,3	203	102	5,8	6,5	8	24,83	190,0	174,0	-	-	-	0,789	40,46
W 200 x 100 x 22.5 ^{*†}	22,5	206	102	6,2	8,0	8	28,65	190,0	174,0	-	-	-	0,794	35,30
W 200 x 135 x 21.4 ^{**†}	19,3	203	134	5,0	6,4	8	27,21	190,2	174,2	M12	62	76	0,918	42,99
W 200 x 135 x 26.6 ^{*†}	26,6	207	133	5,8	8,4	8	33,92	190,2	174,2	M12	62	76	0,921	34,57
W 200 x 135 x 31.3 ^{*†}	31,3	210	134	6,4	10,2	8	40,02	189,6	173,6	M12	64	76	0,929	29,59
W 200 x 165 x 35.9 ^{*†}	35,9	201	165	6,2	10,2	10	45,72	180,6	160,6	M16	78	96	1,032	28,77
W 200 x 165 x 41.7 ^{*†}	41,7	205	166	7,2	11,8	10	53,10	181,4	161,4	M16	80	96	1,042	25,01
W 200 x 200 x 46.1 ^{*†}	46,1	203	203	7,2	11,0	10	58,55	181,0	161,0	M24	94	110	1,186	25,81
W 200 x 200 x 52 ^{*†}	52,0	206	204	7,9	12,6	10	66,55	180,8	160,8	M24	94	110	1,195	22,88
W 200 x 200 x 59 ^{*†}	59,0	210	205	9,1	14,2	10	75,60	181,6	161,6	M24	96	112	1,205	20,30
W 200 x 200 x 71 ^{*†}	71,0	216	206	10,2	17,4	10	91,03	181,2	161,2	M24	98	112	1,218	17,05
W 200 x 200 x 86 ^{*†}	86,0	222	209	13,0	20,6	10	110,5	180,8	160,8	M24	100	116	1,237	14,26
W 200 x 200 x 100 ^{*†}	100	229	210	14,5	23,7	10	126,7	181,6	161,6	M24	102	116	1,252	12,58

* Pedido mínimo: 40 t por perfil y calidad o según acuerdo.

* Tonelaje mínimo y condiciones de suministro previo acuerdo.

♣ Perfil canadiense, el tonelaje mínimo y las condiciones de suministro requieren un acuerdo previo.

* Minimum order: 40t per section and grade or upon agreement.

* Minimum tonnage and delivery conditions upon agreement.

♣ Canadian section, minimum tonnage and delivery conditions upon agreement.

* Ordine minimo: 40t per sezione e qualità o da concordare.

* Tonnellaggio minimo e condizioni di fornitura da concordare.

♣ Profili canadesi, tonnellaggio minimo e condizioni di fornitura secondo accordi.



Páginas de notaciones 199-203 / Notations pages 199-203 / Pagine di annotazioni 199-203

Denominación Designation Designazione (imperial)	Propiedades de perfil / Section properties / Proprietà geometriche del profilo												Classification EN 1993-1-1: 2005						A913	
	eje fuerte y-y strong axis y-y asse forte y-y						eje débil z-z weak axis z-z asse debole z-z						Pure bending y-y			Pure compression				
	G lbs/ft	I_y mm ⁴ x10 ⁴	$W_{el,y}$ mm ³ x10 ³	W_{ply} ♦ mm ³ x10 ³	i_y mm x10	A_vz mm ² x10 ²	I_z mm ⁴ x10 ⁴	$W_{el,z}$ mm ³ x10 ³	$W_{pl,z}$ ♦ mm ³ x10 ³	i_z mm x10	s_s mm	I_t mm ⁴ x10 ⁴	I_w mm ⁶ x10 ⁹	S235	S355	S460	S235	S355		S460
W 4 x 4 x 13	13	475,9	89,79	103,3	4,39	8,27	160,6	31,19	47,94	2,55	31,73	6,52	3,79	1	1	-	1	1	-	✓
W 5 x 5 x 16	16	885,5	139,5	157,2	5,41	9,20	311,0	48,98	74,66	3,20	33,67	8,10	10,80	1	1	-	1	1	-	✓
W 5 x 5 x 19	19	1099	167,7	190,9	5,53	10,53	381,4	59,60	90,86	3,26	38,03	13,33	13,74	1	1	-	1	1	-	✓
W 6 x 4 x 9	9	685,5	91,40	102,4	6,29	7,21	91,80	18,36	28,26	2,30	22,35	1,74	4,79	1	2	-	1	2	-	✓
W 6 x 4 x 12	12	915,9	122,1	138,6	6,33	9,69	125,9	25,37	39,29	2,36	27,47	3,86	6,68	1	1	-	1	1	-	✓
W 6 x 4 x 16	16	1342	167,8	191,5	6,63	11,43	182,6	35,80	55,24	2,45	34,23	9,35	10,21	1	1	-	1	1	-	✓
W 6 x 6 x 15	15	1206	158,6	176,1	6,51	9,59	386,6	50,87	77,56	3,68	26,07	4,34	20,42	3	3	4	3	3	4	✓
W 6 x 6 x 20	20	1714	218,4	243,9	6,73	11,17	555,5	72,62	110,5	3,83	32,23	10,16	30,28	1	1	3	1	1	3	✓
W 6 x 6 x 25	25	2220	274,1	309,9	6,85	13,93	706,8	91,79	140,0	3,86	38,36	19,51	39,93	1	1	1	1	1	1	✓
W 8 x 4 x 10	10	1280	128,0	145,2	8,18	9,80	86,89	17,38	27,10	2,13	24,09	1,93	8,22	1	2	3	3	4	4	✓
W 8 x 4 x 13	13	1662	163,7	188,1	8,17	13,06	115,4	22,63	35,69	2,15	28,21	3,99	11,10	1	1	1	1	2	3	✓
W 8 x 4 x 15	15	2004	194,5	222,8	8,36	14,14	142,0	27,85	43,72	2,22	31,59	5,97	13,87	1	1	1	1	2	3	✓
W 8 x 5.25 x 14	14	1993	196,3	219,0	8,56	11,40	257,0	35,35	58,88	3,07	27,17	3,76	24,80	1	3	3	2	4	4	✓
W 8 x 5.25 x 18	18	2587	250,0	279,8	8,72	13,49	329,8	49,60	76,17	3,11	32,01	7,35	32,48	1	1	2	1	2	4	✓
W 8 x 5.25 x 21	21	3139	298,9	335,3	8,87	14,87	409,6	61,13	93,76	3,20	36,12	12,04	40,82	1	1	1	1	2	2	✓
W 8 x 6.5 x 24	24	3438	342,1	379,4	8,67	14,77	764,3	92,64	141,1	4,09	38,34	14,56	69,50	1	1	2	1	1	2	✓
W 8 x 6.5 x 28	28	4088	398,8	445,6	8,77	17,21	900,5	108,5	165,5	4,12	42,56	22,39	83,95	1	1	1	1	1	1	✓
W 8 x 8 x 31	31	4545	447,8	495,6	8,81	16,96	1535	151,2	229,5	5,12	40,96	22,27	141,3	1	2	3	1	2	3	✓
W 8 x 8 x 35	35	5268	511,5	569,0	8,90	18,60	1784	174,9	265,5	5,18	44,79	32,41	166,7	1	1	2	1	1	2	✓
W 8 x 8 x 40	40	6113	582,2	652,9	8,99	21,59	2040	199,1	302,8	5,19	49,26	46,86	195,4	1	1	1	1	1	1	✓
W 8 x 8 x 48	48	7658	709,0	802,8	9,18	24,52	2537	246,3	374,5	5,28	56,68	82,02	250,0	1	1	1	1	1	1	✓
W 8 x 8 x 58	58	9467	852,9	980,5	9,26	31,06	3138	300,3	458,2	5,33	65,87	140,8	317,8	1	1	1	1	1	1	✓
W 8 x 8 x 67	67	11330	989,1	1149	9,45	35,33	3663	348,9	532,9	5,38	73,60	211,3	385,5	1	1	1	1	1	1	✓

♦ W_{pl} : para el diseño plástico la sección debe pertenecer a la clase 1 o 2 según la capacidad de rotación que se precise. Véase pág. 203.

♦ W_{pl} : for plastic design, the shape must belong to class 1 or 2 according to the required rotation capacity. See page 203.

♦ W_{pl} : per il calcolo plastico, la sezione trasversale deve appartenere alla classe 1 o 2, conformemente alla capacità di rotazione richiesta. Vedere pagina 203.

Perfiles americanos de alas paralelas (continúa)

Dimensiones: ASTM A 6/A 6M - 07

Tolerancias: ASTM A 6/A 6M - 07

Estado de la superficie: conforme a ASTM A 6/A 6M - 07

American wide flange beams (continued)

Dimensions: ASTM A 6/A 6M - 07

Tolerances: ASTM A 6/A 6M - 07

Surface condition: according to ASTM A 6/A 6M - 07

Profili I ad ali parallele (continua)

Dimensioni: ASTM A 6/A 6M - 07

Tolleranze: ASTM A 6/A 6M - 07

Condizioni di superficie: conformi ad ASTM A 6/A 6M - 07

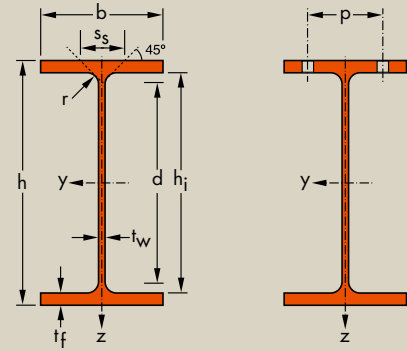

Denominación Designation Designazione (metric)	G kg/m	Dimensiones Dimensions Dimensioni					A mm ² x10 ²	Dimensiones de construcción Dimensions for detailing Dimensioni di dettaglio					Superficie Surface Superficie	
		h mm	b mm	t _w mm	t _f mm	r mm		h _i mm	d mm	Ø mm	p _{min} mm	p _{max} mm	A _L m ² /m	A _C m ² /t
W 250 x 100 x 17.9*	17,9	251	101	4,8	5,3	8	22,79	240,4	224,4	-	-	-	0,883	49,33
W 250 x 100 x 22.3*	22,3	254	102	5,8	6,9	8	28,56	240,2	224,2	-	-	-	0,891	39,73
W 250 x 100 x 25.3*	25,3	257	102	6,1	8,4	8	32,34	240,2	224,2	-	-	-	0,896	35,30
W 250 x 100 x 28.4*	28,4	260	102	6,4	10,0	8	36,31	240,0	224,0	-	-	-	0,901	31,63
W 250 x 145 x 32.7*	32,7	258	146	6,1	9,1	8	41,75	239,8	223,8	M16	72	76	1,074	32,77
W 250 x 145 x 38.5*	38,5	262	147	6,6	11,2	8	49,29	239,6	223,6	M16	74	78	1,085	28,04
W 250 x 145 x 44.8*	44,8	266	148	7,6	13,0	8	57,27	240,0	224,0	M16	74	78	1,095	24,36
W 250 x 200 x 49.1*	49,1	247	202	7,4	11,0	13	62,54	225,0	199,0	M27	90	112	1,265	25,76
W 250 x 200 x 58*	58,0	252	203	8,0	13,5	13	74,26	225,0	199,0	M27	90	113	1,278	21,92
W 250 x 200 x 67*	67,0	257	204	8,9	15,7	13	85,59	225,6	199,6	M27	90	114	1,290	19,20
W 250 x 250 x 73*	73,0	253	254	8,6	14,2	13	92,90	224,6	198,6	M27	102	148	1,482	20,33
W 250 x 250 x 80*	80,0	256	255	9,4	15,6	13	102,1	224,8	198,8	M27	102	150	1,491	18,59
W 250 x 250 x 89*	89,0	260	256	10,7	17,3	13	114,1	225,4	199,4	M27	104	150	1,500	16,74
W 250 x 250 x 101*	101	264	257	11,9	19,6	13	128,9	224,8	198,8	M27	106	152	1,510	14,92
W 250 x 250 x 115*	115	269	259	13,5	22,1	13	146,3	224,8	198,8	M27	106	154	1,525	13,28
W 250 x 250 x 131*	131	275	261	15,4	25,1	13	167,1	224,8	198,8	M27	108	156	1,541	11,75
W 250 x 250 x 149*	149	282	263	17,3	28,4	13	189,8	225,2	199,2	M27	110	158	1,559	10,46
W 250 x 250 x 167*	167	289	265	19,2	31,8	13	213,3	225,4	199,4	M27	112	160	1,577	9,421
W 310 x 100 x 21.0*	21,0	303	101	5,1	5,7	8	26,93	291,6	275,6	-	-	-	0,986	46,64
W 310 x 100 x 23.8*	23,8	305	101	5,6	6,7	8	30,41	291,6	275,6	-	-	-	0,989	41,43
W 310 x 100 x 28.3*	28,3	309	102	6,0	8,9	8	36,18	291,2	275,2	-	-	-	1,000	35,22
W 310 x 100 x 32.7*	32,7	313	102	6,6	10,8	8	41,81	291,4	275,4	-	-	-	1,007	30,68
W 310 x 165 x 38.7*	38,7	310	165	5,8	9,7	8	49,41	290,6	274,6	M20	80	84	1,255	32,34
W 310 x 165 x 44.5*	44,5	313	166	6,6	11,2	8	56,91	290,6	274,6	M20	80	84	1,263	28,27
W 310 x 165 x 52*	52,0	317	167	7,6	13,2	8	66,72	290,6	274,6	M20	82	86	1,273	24,31
W 310 x 200 x 60*	60,0	303	203	7,5	13,1	15	75,88	276,8	246,8	M27	90	113	1,377	23,12
W 310 x 200 x 67*	67,0	306	204	8,5	14,6	15	85,03	276,8	246,8	M27	90	114	1,385	20,75
W 310 x 200 x 74*	74,0	310	205	9,4	16,3	15	94,84	277,4	247,4	M27	90	115	1,395	18,74

* Pedido mínimo: 40 t por perfil y calidad o según acuerdo.

* Minimum order: 40t per section and grade or upon agreement.

* Ordine minimo: 40t per sezione e qualità o da concordare.

W

Páginas de notaciones 199-203 / Notations pages 199-203 / Pagine di annotazioni 199-203

Denominación Designation Designazione (imperial)	Propiedades de perfil / Section properties / Proprietà geometriche del profilo												Classification EN 1993-1-1: 2005						A913	
	eje fuerte y-y strong axis y-y asse forte y-y						eje débil z-z weak axis z-z asse debole z-z						Pure bending y-y			Pure compression				
	G lbs/ft	I_y mm ⁴ x10 ⁴	$W_{el,y}$ mm ³ x10 ³	$W_{pl,y} \blacklozenge$ mm ³ x10 ³	i_y mm x10	A_v mm ² x10 ²	I_z mm ⁴ x10 ⁴	$W_{el,z}$ mm ³ x10 ³	$W_{pl,z} \blacklozenge$ mm ³ x10 ³	i_z mm x10	s_s mm	I_t mm ⁴ x10 ⁴	I_w mm ⁶ x10 ⁹	S235	S355	S460	S235	S355		S460
W 10 x 4 x 12	12	2252	179,5	207,8	9,92	13,26	91,34	18,09	28,67	2,00	24,80	2,50	13,74	1	2	3	4	4	4	✓
W 10 x 4 x 15	15	2901	228,4	264,6	10,06	16,08	122,6	24,03	38,20	2,07	29,01	4,68	18,63	1	1	1	3	4	4	✓
W 10 x 4 x 17	17	3430	266,9	307,5	10,30	17,06	149,2	29,25	46,20	2,15	32,27	6,77	22,95	1	1	1	2	4	4	✓
W 10 x 4 x 19	19	3998	307,5	352,9	10,51	18,02	177,5	34,81	54,71	2,21	35,72	9,80	27,64	1	1	1	2	4	4	✓
W 10 x 5.75 x 22	22	4895	379,4	424,9	10,83	17,19	472,6	64,74	99,48	3,36	33,67	10,05	73,10	1	1	-	2	4	-	✓
W 10 x 5.75 x 26	26	6014	459,1	514,1	11,05	18,89	593,7	80,77	123,9	3,47	38,37	17,03	93,24	1	1	-	2	3	-	✓
W 10 x 5.75 x 30	30	7118	535,2	603,0	11,14	21,91	703,5	95,06	146,2	3,50	42,99	26,45	112,4	1	1	-	1	2	-	✓
W 10 x 8 x 33	33	7069	572,4	633,9	10,63	21,77	1513	149,8	228,5	4,92	44,63	24,53	210,4	1	2	-	1	2	-	✓
W 10 x 8 x 39	39	8736	693,4	770,8	10,85	24,04	1884	185,6	282,8	5,04	50,23	41,11	267,7	1	1	-	1	1	-	✓
W 10 x 8 x 45	45	10360	806,6	902,0	11,00	27,01	2224	218,0	332,2	5,10	55,53	62,61	323,4	1	1	-	1	1	-	✓
W 10 x 10 x 49	49	11290	892,1	986,1	11,02	25,78	3880	305,5	463,3	6,46	52,27	57,94	552,9	1	2	3	1	2	3	✓
W 10 x 10 x 54	54	12570	982,4	1091	11,10	28,10	4314	338,3	513,3	6,50	55,83	76,15	622,9	1	1	2	1	1	2	✓
W 10 x 10 x 60	60	14260	1097	1226	11,18	31,84	4841	378,2	574,5	6,51	60,50	104,4	712,4	1	1	1	1	1	1	✓
W 10 x 10 x 68	68	16380	1241	1398	11,27	35,73	5549	431,9	656,6	6,56	66,37	150,3	828,0	1	1	1	1	1	1	✓
W 10 x 10 x 77	77	18940	1408	1599	11,38	40,43	6405	494,6	752,8	6,62	72,89	215,3	975,3	1	1	1	1	1	1	✓
W 10 x 10 x 88	88	22150	1611	1847	11,52	46,39	7446	570,6	869,7	6,68	80,80	315,9	1161	1	1	1	1	1	1	✓
W 10 x 10 x 100	100	25940	1840	2129	11,69	52,63	8622	655,7	1001	6,74	89,30	456,5	1384	1	1	1	1	1	1	✓
W 10 x 10 x 112	112	30020	2078	2427	11,87	59,05	9879	745,6	1139	6,81	98,01	639,3	1631	1	1	1	1	1	1	✓
W 12 x 4 x 14	14	3708	244,8	287,1	11,75	16,56	98,31	19,47	31,19	1,91	25,85	3,17	21,63	1	1	-	4	4	-	✓
W 12 x 4 x 16	16	4280	280,7	328,6	11,87	18,3	115,6	22,89	36,70	1,95	28,36	4,50	25,59	1	1	-	4	4	-	✓
W 12 x 4 x 19	19	5431	351,5	406,9	12,27	19,89	158,1	30,99	49,15	2,09	33,14	7,72	35,44	1	1	-	4	4	-	✓
W 12 x 4 x 22	22	6507	415,8	480,9	12,47	22,22	191,9	37,62	59,63	2,14	37,57	12,36	43,61	1	1	-	3	4	-	✓
W 12 x 6.5 x 26	26	8527	550,1	611,8	13,12	19,64	726,8	88,10	134,8	3,83	34,61	12,76	163,7	1	2	-	4	4	-	✓
W 12 x 6.5 x 30	30	9934	634,8	708,3	13,21	22,26	854,7	103,0	157,8	3,88	38,37	19,30	194,4	1	1	-	3	4	-	✓
W 12 x 6.5 x 35	35	11850	747,7	838,5	13,32	25,81	1026	122,9	188,6	3,92	43,39	31,10	236,4	1	1	-	2	4	-	✓
W 12 x 8 x 40	40	12860	848,9	940,7	13,02	27,60	1829	180,2	275,2	4,91	51,27	39,15	383,7	1	1	-	1	3	-	✓
W 12 x 8 x 45	45	14510	948,4	1057	13,06	31,08	2069	202,8	310,3	4,93	55,27	54,03	438,5	1	1	-	1	2	-	✓
W 12 x 8 x 50	50	16450	1061	1188	13,17	34,43	2344	228,7	350,2	4,97	59,57	74,05	504,7	1	1	-	1	1	-	✓

◆ W_{pl} : para el diseño plástico la sección debe pertenecer a la clase 1 o 2 según la capacidad de rotación que se precise. Véase pág. 203.

◆ W_{pl} : for plastic design, the shape must belong to class 1 or 2 according to the required rotation capacity. See page 203.

◆ W_{pl} : per il calcolo plastico, la sezione trasversale deve appartenere alla classe 1 o 2, conformemente alla capacità di rotazione richiesta. Vedere pagina 203.

Perfiles americanos de alas paralelas (continúa)

Dimensiones: ASTM A 6/A 6M - 07

Tolerancias: ASTM A 6/A 6M - 07

Estado de la superficie: conforme a ASTM A 6/A 6M - 07

American wide flange beams (continued)

Dimensions: ASTM A 6/A 6M - 07

Tolerances: ASTM A 6/A 6M - 07

Surface condition: according to ASTM A 6/A 6M - 07

Profili I ad ali parallele (continua)

Dimensioni: ASTM A 6/A 6M - 07

Tolleranze: ASTM A 6/A 6M - 07

Condizioni di superficie: conformi ad ASTM A 6/A 6M - 07

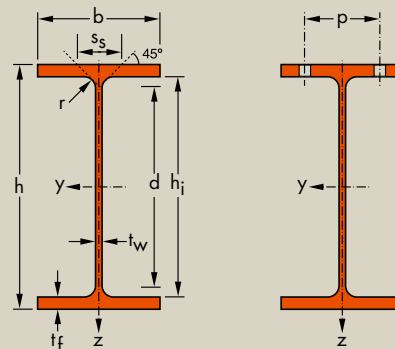

Denominación Designation Designazione (metric)	G kg/m	Dimensiones Dimensions Dimensioni					A mm ² x10 ²	Dimensiones de construcción Dimensions for detailing Dimensioni di dettaglio					Superficie Surface Superficie	
		h mm	b mm	t _w mm	t _f mm	r mm		h _i mm	d mm	Ø mm	p _{min} mm	p _{max} mm	A _L m ² /m	A _C m ² /t
W 310 x 250 x 79*	79,0	306	254	8,8	14,6	15	100,5	276,8	246,8	M27	90	164	1,585	20,09
W 310 x 250 x 86*	86,0	310	254	9,1	16,3	15	110,0	277,4	247,4	M27	90	164	1,592	18,44
W 310 x 310 x 97**	97,0	308	305	9,9	15,4	15	123,3	277,2	247,2	M27	102	200	1,790	18,50
W 310 x 310 x 107*	107	311	306	10,9	17,0	15	136,2	277,0	247,0	M27	104	200	1,798	16,83
W 310 x 310 x 117*	117	314	307	11,9	18,7	15	149,7	276,6	246,6	M27	106	202	1,806	15,38
W 310 x 310 x 129*	129	318	308	13,1	20,6	15	165,1	276,8	246,8	M27	106	202	1,816	14,01
W 310 x 310 x 143*	143	323	309	14,0	22,9	15	182,3	277,2	247,2	M27	108	204	1,828	12,78
W 310 x 310 x 158*	158	327	310	15,5	25,1	15	200,5	276,8	246,8	M27	108	204	1,837	11,68
W 310 x 310 x 179*	179	333	313	18,0	28,1	15	227,7	276,8	246,8	M27	112	208	1,856	10,39
W 310 x 310 x 202*	202	341	315	20,1	31,8	15	258,0	277,4	247,4	M27	114	210	1,876	9,262
W 310 x 310 x 226*	226	348	317	22,1	35,6	15	288,8	276,8	246,8	M27	116	212	1,894	8,354
W 310 x 310 x 253*	253	356	319	24,4	39,6	15	322,1	276,8	246,8	M27	118	214	1,913	7,567
W 310 x 310 x 283*	283	365	322	26,9	44,1	15	360,4	276,8	246,8	M27	120	216	1,938	6,852
W 310 x 310 x 313*	313	374	325	30,0	48,3	15	399,1	277,4	247,4	M27	124	220	1,962	6,263
W 310 x 310 x 342*	342	382	328	32,6	52,6	15	437,2	276,8	246,8	M27	126	222	1,985	5,784
W 360 x 130 x 32.9*	32,9	349	127	5,8	8,5	10	41,70	332,0	312,0	M12	62	70	1,177	35,96
W 360 x 130 x 39.0*	39,0	353	128	6,5	10,7	10	49,80	331,6	311,6	M12	64	70	1,188	30,38
W 360 x 170 x 44.6*	44,6	352	171	6,9	9,8	10	57,31	332,4	312,4	M22	82	84	1,357	30,16
W 360 x 170 x 51*	51,0	355	171	7,2	11,6	10	64,42	331,8	311,8	M22	84	84	1,362	26,94
W 360 x 170 x 58*	58,0	358	172	7,9	13,1	10	72,13	331,8	311,8	M22	84	84	1,371	24,21
W 360 x 200 x 64*	64,0	347	203	7,7	13,5	15	81,38	320,0	290,0	M27	90	113	1,465	22,93
W 360 x 200 x 72*	72,0	350	204	8,6	15,1	15	91,04	319,8	289,8	M27	90	114	1,473	20,61
W 360 x 200 x 79*	79,0	354	205	9,4	16,8	15	100,9	320,4	290,4	M27	90	115	1,483	18,72
W 360 x 250 x 91*	91,0	353	254	9,5	16,4	15	115,7	320,2	290,2	M27	90	164	1,677	18,47
W 360 x 250 x 101*	101	357	255	10,5	18,3	15	128,9	320,4	290,4	M27	91	165	1,687	16,67
W 360 x 250 x 110*	110	360	256	11,4	19,9	15	140,3	320,2	290,2	M27	91	166	1,695	15,39
W 360 x 250 x 122*	122	363	257	13,0	21,7	15	155,0	319,6	289,6	M27	93	167	1,702	13,99

* Pedido mínimo: 40 t por perfil y calidad o según acuerdo.

♣ Perfil canadiense, el tonelaje mínimo y las condiciones de suministro requieren un acuerdo previo.

* Minimum order: 40t per section and grade or upon agreement.

♣ Canadian section, minimum tonnage and delivery conditions upon agreement.

* Ordine minimo: 40t per sezione e qualità o da concordare.

♣ Profili canadesi, tonnellaggio minimo e condizioni di fornitura secondo accordi.



Páginas de notaciones 199-203 / Notations pages 199-203 / Pagine di annotazioni 199-203

Denominación Designation Designazione (imperial)	Propiedades de perfil / Section properties / Proprietà geometriche del profilo												Classification EN 1993-1-1: 2005						A913		
	eje fuerte y-y strong axis y-y asse forte y-y						eje débil z-z weak axis z-z asse debole z-z						Pure bending y-y			Pure compression					
	G lbs/ft	I_y mm ⁴ x10 ⁴	$W_{el,y}$ mm ³ x10 ³	$W_{pl,y}$ ♦ mm ³ x10 ³	i_y mm x10	A_v mm ² x10 ²	I_z mm ⁴ x10 ⁴	$W_{el,z}$ mm ³ x10 ³	$W_{pl,z}$ ♦ mm ³ x10 ³	i_z mm x10	s_s mm	I_t mm ⁴ x10 ⁴	I_w mm ⁶ x10 ⁹	S235	S355	S460	S235	S355		S460	A572/A709/A992
W 12 x 10 x 53	53	17670	1155	1275	13,26	31,95	3990	314,2	477,8	6,30	55,57	65,49	846,5	1	2	-	1	2	-	✓	
W 12 x 10 x 58	58	19850	1280	1417	13,43	33,55	4455	350,8	533,1	6,36	59,27	86,96	960,0	1	1	-	1	2	-	✓	
W 12 x 12 x 65	65	22240	1444	1591	13,43	35,52	7286	477,8	724,7	7,69	58,27	91,50	1559	1	3	3	1	3	3	✓	✓
W 12 x 12 x 72	72	24790	1594	1765	13,49	39,08	8123	530,9	805,8	7,72	62,47	122,1	1754	1	2	3	1	2	3	✓	✓
W 12 x 12 x 79	79	27510	1753	1949	13,56	42,68	9024	587,9	892,8	7,76	66,87	161,1	1966	1	1	2	1	1	2	✓	✓
W 12 x 12 x 87	87	30770	1935	2164	13,65	47,07	10040	651,9	990,9	7,80	71,87	214,5	2218	1	1	1	1	1	1	✓	✓
W 12 x 12 x 96	96	34760	2153	2419	13,81	50,82	11270	729,4	1109	7,86	77,37	288,3	2535	1	1	1	1	1	1	✓	✓
W 12 x 12 x 106	106	38630	2363	2672	13,88	56,26	12470	804,8	1225	7,89	83,27	380,3	2840	1	1	1	1	1	1	✓	✓
W 12 x 12 x 120	120	44530	2675	3053	13,99	65,24	14380	918,7	1401	7,95	91,77	543,7	3338	1	1	1	1	1	1	✓	✓
W 12 x 12 x 136	136	51982	3049	3510	14,19	73,62	16590	1053	1608	8,02	101,3	782,7	3959	1	1	1	1	1	1	✓	✓
W 12 x 12 x 152	152	59560	3423	3975	14,36	81,65	18930	1194	1825	8,10	110,9	1089	4611	1	1	1	1	1	1	✓	✓
W 12 x 12 x 170	170	68230	3833	4490	14,55	91,01	21460	1346	2059	8,16	121,2	1495	5362	1	1	1	1	1	1	✓	✓
W 12 x 12 x 190	190	78680	4311	5098	14,78	101,5	24590	1527	2340	8,26	132,7	2062	6317	1	1	1	1	1	1	✓	✓
W 12 x 12 x 210	210	89560	4789	5716	14,98	114,1	27700	1705	2617	8,33	144,2	2742	7329	1	1	1	1	1	1	✓	✓
W 12 x 12 x 230	230	100500	5262	6334	15,16	125,1	31020	1892	2907	8,42	155,4	3552	8392	1	1	1	1	1	1	✓	✓
W 14 x 5 x 22	22	8258	473,2	541,5	14,07	22,31	291,0	45,82	71,80	2,64	34,52	8,65	84,11	1	1	-	4	4	-	✓	
W 14 x 5 x 26	26	10230	579,7	661,5	14,33	25,25	375,0	58,60	91,60	2,74	39,62	15,04	109,6	1	1	-	4	4	-	✓	
W 14 x 6.75 x 30	30	12140	690,1	777,0	14,57	26,29	817,9	95,66	147,7	3,78	38,18	16,10	239,1	1	2	-	4	4	-	✓	
W 14 x 6.75 x 34	34	14130	796,3	894,5	14,80	28,04	968,1	113,2	174,4	3,87	42,16	23,92	285,0	1	1	-	4	4	-	✓	
W 14 x 6.75 x 38	38	16040	896,2	1009	14,91	30,73	1113	129,4	199,5	3,93	45,82	33,46	330,4	1	1	-	3	4	-	✓	
W 14 x 8 x 43	43	17830	1027	1141	14,80	31,66	1885	185,7	284,3	4,81	52,27	43,21	523,4	1	1	-	2	4	-	✓	
W 14 x 8 x 48	48	20100	1149	1282	14,86	35,26	2140	209,8	321,6	4,85	56,37	59,71	599,1	1	1	-	2	3	-	✓	
W 14 x 8 x 53	53	22650	1280	1433	14,98	38,67	2416	235,7	361,6	4,89	60,57	80,72	685,7	1	1	-	1	2	-	✓	
W 14 x 10 x 61	61	26690	1512	1676	15,19	38,83	4483	353,0	537,8	6,23	59,87	91,18	1269	1	1	-	1	2	-	✓	
W 14 x 10 x 68	68	30150	1689	1880	15,29	42,98	5062	397,0	605,5	6,27	64,67	125,3	1450	1	1	-	1	2	-	✓	
W 14 x 10 x 74	74	33090	1838	2055	15,36	46,67	5570	435,2	664,2	6,30	68,77	160,3	1609	1	1	-	1	1	-	✓	
W 14 x 10 x 82	82	36530	2013	2266	15,35	52,81	6147	478,4	732,0	6,30	73,97	211,8	1788	1	1	-	1	1	-	✓	

♦ W_{pl} : para el diseño plástico la sección debe pertenecer a la clase 1 o 2 según la capacidad de rotación que se precise. Véase pág. 203.

♦ W_{pl} : for plastic design, the shape must belong to class 1 or 2 according to the required rotation capacity. See page 203.

♦ W_{pl} : per il calcolo plastico, la sezione trasversale deve appartenere alla classe 1 o 2, conformemente alla capacità di rotazione richiesta. Vedere pagina 203.

Perfiles americanos de alas paralelas (continúa)

Dimensiones: ASTM A 6/A 6M - 07

Tolerancias: ASTM A 6/A 6M - 07

Estado de la superficie: conforme a ASTM A 6/A 6M - 07

American wide flange beams (continued)

Dimensions: ASTM A 6/A 6M - 07

Tolerances: ASTM A 6/A 6M - 07

Surface condition: according to ASTM A 6/A 6M - 07

Profili I ad ali parallele (continua)

Dimensioni: ASTM A 6/A 6M - 07

Tolleranze: ASTM A 6/A 6M - 07

Condizioni di superficie: conformi ad ASTM A 6/A 6M - 07

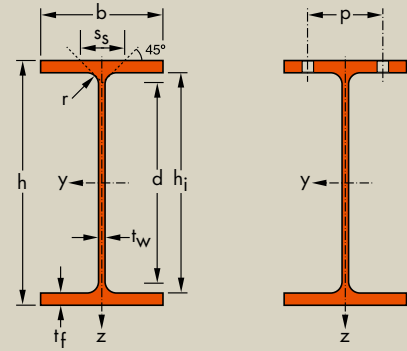

Denominación Designation Designazione (metric)	G kg/m	Dimensiones Dimensions Dimensioni					A mm ² x10 ²	Dimensiones de construcción Dimensions for detailing Dimensioni di dettaglio					Superficie Surface Superficie	
		h mm	b mm	t _w mm	t _f mm	r mm		h _i mm	d mm	Ø mm	p _{min} mm	p _{max} mm	A _L m ² /m	A _C m ² /t
W 360 x 370 x 134*	134	356	369	11,2	18,0	15	170,6	320,0	290,0	M27	100	264	2,140	15,98
W 360 x 370 x 147*	147	360	370	12,3	19,8	15	187,9	320,4	290,4	M27	100	264	2,150	14,58
W 360 x 370 x 162*	162	364	371	13,3	21,8	15	206,3	320,4	290,4	M27	102	266	2,160	13,34
W 360 x 370 x 179*	179	368	373	15,0	23,9	15	228,3	320,2	290,2	M27	104	268	2,172	12,12
W 360 x 370 x 196*	196	372	374	16,4	26,2	15	250,3	319,6	289,6	M27	104	268	2,181	11,10
W 360 x 410 x 216*	216	375	394	17,3	27,7	15	275,5	319,6	289,6	M27	106	288	2,266	10,48
W 360 x 410 x 237*	237	380	395	18,9	30,2	15	300,9	319,6	289,6	M27	108	290	2,276	9,637
W 360 x 410 x 262*	262	387	398	21,1	33,3	15	334,6	320,4	290,4	M27	110	292	2,298	8,749
W 360 x 410 x 287*	287	393	399	22,6	36,6	15	366,3	319,8	289,8	M27	112	294	2,311	8,038
W 360 x 410 x 314*	314	399	401	24,9	39,6	15	399,2	319,8	289,8	M27	114	296	2,326	7,425
W 360 x 410 x 347*	347	407	404	27,2	43,7	15	442,0	319,6	289,6	M27	116	298	2,350	6,773
W 360 x 410 x 382*	382	416	406	29,8	48,0	15	487,1	320,0	290,0	M27	118	300	2,371	6,200
W 360 x 410 x 421*	421	425	409	32,8	52,6	15	537,1	319,8	289,8	M27	122	304	2,395	5,680
W 360 x 410 x 463*	463	435	412	35,8	57,4	15	589,5	320,2	290,2	M27	124	306	2,421	5,231
W 360 x 410 x 509*	509	446	416	39,1	62,7	15	649,0	320,6	290,6	M27	128	310	2,452	4,813
W 360 x 410 x 551*	551	455	418	42,0	67,6	15	701,4	319,8	289,8	M27	132	312	2,472	4,490
W 360 x 410 x 592*	592	465	421	45,0	72,3	15	754,9	320,4	290,4	M27	134	316	2,498	4,216
W 360 x 410 x 634*	634	474	424	47,6	77,1	15	808,0	319,8	289,8	M27	140	312	2,523	3,978
W 360 x 410 x 677*	677	483	428	51,2	81,5	15	863,4	320,0	290,0	M27	144	316	2,550	3,762
W 360 x 410 x 744*	744	498	432	55,6	88,9	15	948,1	320,2	290,2	M27	148	320	2,587	3,476
W 360 x 410 x 818*	818	514	437	60,5	97,0	15	1043	320,0	290,0	M27	154	326	2,629	3,210
W 360 x 410 x 900*	900	531	442	65,9	106	15	1149	319,0	289,0	M27	158	330	2,672	2,962
W 360 x 410 x 990*	990	550	448	71,9	115	15	1262	320,0	290,0	M27	164	336	2,722	2,747
W 360 x 410 x 1086*	1086	569	454	78,0	125	15	1386	319,0	289,0	M27	170	342	2,772	2,548
W 410 x 140 x 38.8*	38,8	399	140	6,4	8,8	10	49,91	381,4	361,4	M12	68	82	1,328	33,90
W 410 x 140 x 46.1*	46,1	403	140	7,0	11,2	10	58,86	380,6	360,6	M12	68	82	1,335	28,89

* Pedido mínimo: 40 t por perfil y calidad o según acuerdo.

* Minimum order: 40t per section and grade or upon agreement.

* Ordine minimo: 40t per sezione e qualità o da concordare.



Páginas de notaciones 199-203 / Notations pages 199-203 / Pagine di annotazioni 199-203

Denominación Designation Designazione (imperial)	Propiedades de perfil / Section properties / Proprietà geometriche del profilo												Classification EN 1993-1-1: 2005						A913		
	eje fuerte y-y strong axis y-y asse forte y-y						eje débil z-z weak axis z-z asse debole z-z						Pure bending y-y			Pure compression					
	G lbs/ft	I_y mm ⁴ x10 ⁴	$W_{el,y}$ mm ³ x10 ³	$W_{pl,y} \blacklozenge$ mm ³ x10 ³	i_y mm x10	A_v mm ² x10 ²	I_z mm ⁴ x10 ⁴	$W_{el,z}$ mm ³ x10 ³	$W_{pl,z} \blacklozenge$ mm ³ x10 ³	i_z mm x10	s_s mm	I_t mm ⁴ x10 ⁴	I_w mm ⁶ x10 ⁹	S235	S355	S460	S235	S355		S460	A572/A709/A992
W 14 x 14.5 x 90	90	41510	2332	2562	15,60	45,19	15080	817,3	1237	9,40	64,77	168,8	4305	2	3	3	2	3	3	✓	✓
W 14 x 14.5 x 99	99	46290	2572	2838	15,70	49,72	16720	903,9	1369	9,43	69,47	223,7	4836	1	3	3	1	3	3	✓	✓
W 14 x 14.5 x 109	109	51540	2832	3139	15,81	53,98	18560	1001	1516	9,49	74,47	295,5	5432	1	2	3	1	2	3	✓	✓
W 14 x 14.5 x 120	120	57440	3122	3482	15,86	60,72	20680	1109	1683	9,52	80,37	393,8	6119	1	1	2	1	1	2	✓	✓
W 14 x 14.5 x 132	132	63630	3421	3837	15,94	66,50	22860	1222	1856	9,56	86,37	517,1	6829	1	1	1	1	1	1	✓	✓
W 14 x 16 x 145	145	71140	3794	4262	16,07	70,32	28250	1434	2176	10,13	90,27	637,3	8515	1	1	1	1	1	1	✓	✓
W 14 x 16 x 159	159	78780	4146	4686	16,18	77,10	31040	1572	2387	10,16	96,87	825,5	9489	1	1	1	1	1	1	✓	✓
W 14 x 16 x 176	176	89410	4620	5260	16,35	86,55	35020	1760	2676	10,23	105,3	1116	10940	1	1	1	1	1	1	✓	✓
W 14 x 16 x 193	193	99710	5074	5813	16,50	93,46	38780	1944	2957	10,29	113,4	1464	12300	1	1	1	1	1	1	✓	✓
W 14 x 16 x 211	211	110200	5525	6374	16,62	103,3	42600	2125	3236	10,33	121,7	1870	13740	1	1	1	1	1	1	✓	✓
W 14 x 16 x 233	233	124900	6140	7139	16,81	113,9	48090	2380	3629	10,43	132,2	2510	15850	1	1	1	1	1	1	✓	✓
W 14 x 16 x 257	257	141300	6794	7965	17,03	126,0	53620	2641	4031	10,49	143,4	3326	18130	1	1	1	1	1	1	✓	✓
W 14 x 16 x 283	283	159600	7510	8880	17,24	139,9	60080	2938	4489	10,58	155,6	4398	20800	1	1	1	1	1	1	✓	✓
W 14 x 16 x 311	311	180200	8283	9878	17,48	154,3	67040	3254	4978	10,66	168,2	5735	23850	1	1	1	1	1	1	✓	✓
W 14 x 16 x 342	342	204500	9172	11030	17,75	170,6	75400	3625	5552	10,78	182,1	7513	27630	1	1	1	1	1	1	✓	✓
W 14 x 16 x 370	370	226100	9939	12050	17,95	184,9	82490	3947	6051	10,85	194,8	9410	30870	1	1	1	1	1	1	✓	✓
W 14 x 16 x 398	398	250200	10760	13140	18,20	200,3	90170	4284	6574	10,93	207,2	11560	34670	1	1	1	1	1	1	✓	✓
W 14 x 16 x 426	426	274200	11570	14220	18,42	214,0	98250	4634	7117	11,03	219,4	14020	38570	1	1	1	1	1	1	✓	✓
W 14 x 16 x 455	455	299500	12400	15350	18,62	231,9	106900	4994	7680	11,13	231,8	16790	42920	1	1	1	1	1	1	✓	✓
W 14 x 16 x 500	500	342100	13740	17170	19,00	256,1	119900	5552	8549	11,25	251,0	21840	49980	1	1	1	1	1	1	✓	✓
W 14 x 16 x 550	550	392200	15260	19260	19,39	283,3	135500	6203	9561	11,40	272,1	28510	58650	1	1	1	1	1	1	✓	✓
W 14 x 16 x 605	605	450200	16960	21620	19,79	313,8	153300	6938	10710	11,55	295,5	37350	68890	1	1	1	1	1	1	✓	✓
W 14 x 16 x 665	665	518900	18870	24280	20,27	349,2	173400	7739	11960	11,72	319,5	48210	81530	1	1	1	1	1	1	✓	✓
W 14 x 16 x 730	730	595700	20940	27210	20,73	385,8	196200	8645	13380	11,90	345,6	62290	96080	1	1	1	1	1	1	✓	✓
W 16 x 5.5 x 26	26	12620	632,6	727,8	15,93	27,40	403,5	57,65	90,55	2,85	35,67	11,17	153,2	1	1	-	4	4	-	✓	
W 16 x 5.5 x 31	31	15550	771,9	883,6	16,26	30,49	513,6	73,37	114,9	2,95	41,11	19,25	196,6	1	1	-	4	4	-	✓	

- ◆ W_{pl} : para el diseño plástico la sección debe pertenecer a la clase 1 o 2 según la capacidad de rotación que se precise. Véase pág. 203.
- ◆ W_{pl} : for plastic design, the shape must belong to class 1 or 2 according to the required rotation capacity. See page 203.
- ◆ W_{pl} : per il calcolo plastico, la sezione trasversale deve appartenere alla classe 1 o 2, conformemente alla capacità di rotazione richiesta. Vedere pagina 203.

Perfiles americanos de alas paralelas (continúa)

Dimensiones: ASTM A 6/A 6M - 07
Tolerancias: ASTM A 6/A 6M - 07
Estado de la superficie: conforme a ASTM A 6/A 6M - 07

American wide flange beams (continued)

Dimensions: ASTM A 6/A 6M - 07
Tolerances: ASTM A 6/A 6M - 07
Surface condition: according to ASTM A 6/A 6M - 07

Profili I ad ali paralele (continua)

Dimensioni: ASTM A 6/A 6M - 07
Tolleranze: ASTM A 6/A 6M - 07
Condizioni di superficie: conformi ad ASTM A 6/A 6M - 07

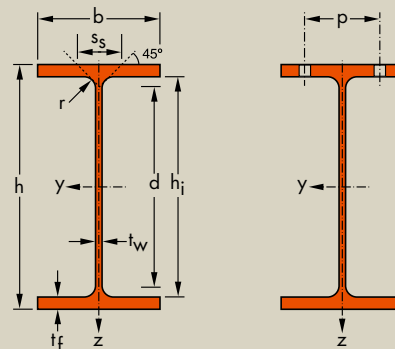

Denominación Designation Designazione (metric)	G kg/m	Dimensiones Dimensions Dimensioni					A mm ² x10 ²	Dimensiones de construcción Dimensions for detailing Dimensioni di dettaglio					Superficie Surface Superficie	
		h mm	b mm	t _w mm	t _f mm	r mm		h _i mm	d mm	Ø mm	p _{min} mm	p _{max} mm	A _L m ² /m	A _C m ² /t
W 410 x 180 x 53*	53,0	403	177	7,5	10,9	10	68,03	381,2	361,2	M22	86	90	1,482	27,75
W 410 x 180 x 60*	60,0	407	178	7,7	12,8	10	75,79	381,4	361,4	M22	86	90	1,493	25,10
W 410 x 180 x 67*	67,0	410	179	8,8	14,4	10	85,96	381,2	361,2	M22	86	92	1,501	22,25
W 410 x 180 x 75*	75,0	413	180	9,7	16,0	10	95,42	381,0	361,0	M22	88	92	1,509	20,15
W 410 x 180 x 85*	85,0	417	181	10,9	18,2	10	108,2	380,6	360,6	M22	90	94	1,519	17,88
W 410 x 260 x 100*	100	415	260	10,0	16,9	10	126,9	381,2	361,2	M27	90	170	1,833	18,40
W 410 x 260 x 114*	114	420	261	11,6	19,3	10	145,8	381,4	361,4	M27	92	171	1,844	16,10
W 410 x 260 x 132*	132	425	263	13,3	22,2	10	168,3	380,6	360,6	M27	93	173	1,858	14,07
W 410 x 260 x 149*	149	431	265	14,9	25,0	10	190,1	381,0	361,0	M27	95	175	1,875	12,56
W 460 x 150 x 52*	52,0	450	152	7,6	10,8	10	66,25	428,4	408,4	M16	76	82	1,476	28,37
W 460 x 150 x 60*	60,0	455	153	8,0	13,3	10	75,83	428,4	408,4	M16	76	84	1,489	25,01
W 460 x 150 x 68*	68,0	459	154	9,1	15,4	10	87,26	428,2	408,2	M16	78	84	1,499	21,88
W 460 x 190 x 74*	74,0	457	190	9,0	14,5	10	94,48	428,0	408,0	M24	92	96	1,639	22,10
W 460 x 190 x 82*	82,0	460	191	9,9	16,0	10	104,4	428,0	408,0	M24	92	98	1,647	20,11
W 460 x 190 x 89*	89,0	463	192	10,5	17,7	10	113,7	427,6	407,6	M24	94	98	1,656	18,55
W 460 x 190 x 97*	97,0	466	193	11,4	19,0	10	123,0	427,8	407,8	M24	94	100	1,664	17,24
W 460 x 190 x 106*	106	469	194	12,6	20,6	10	134,7	427,8	407,8	M24	96	100	1,672	15,81
W 460 x 280 x 113*	113	463	280	10,8	17,3	10	144,0	428,4	408,4	M27	90	174	2,007	17,76
W 460 x 280 x 128*	128	467	282	12,2	19,6	10	163,6	427,8	407,8	M27	90	176	2,020	15,73
W 460 x 280 x 144*	144	472	283	13,6	22,1	10	184,1	427,8	407,8	M27	92	178	2,032	14,06
W 460 x 280 x 158*	158	476	284	15,0	23,9	10	200,8	428,2	408,2	M27	94	178	2,041	12,94
W 460 x 280 x 177*	177	482	286	16,6	26,9	10	225,8	428,2	408,2	M27	94	180	2,058	11,61
W 460 x 280 x 193*	193	489	283	17,0	30,5	10	246,2	428,0	408,0	M27	97	193	2,059	10,65
W 460 x 280 x 213*	213	495	285	18,5	33,5	10	271,0	428,0	408,0	M27	99	195	2,076	9,758
W 460 x 280 x 235*	235	501	287	20,6	36,6	10	299,1	427,8	407,8	M27	101	197	2,092	8,909
W 460 x 280 x 260*	260	509	289	22,6	40,4	10	331,1	428,2	408,2	M27	103	199	2,112	8,123

* Pedido mínimo: 40 t por perfil y calidad o según acuerdo.

* Minimum order: 40t per section and grade or upon agreement.

* Ordine minimo: 40t per sezione e qualità o da concordare.

W

Páginas de notaciones 199-203 / Notations pages 199-203 / Pagine di annotazioni 199-203

Denominación Designation Designazione (imperial)	Propiedades de perfil / Section properties / Proprietà geometriche del profilo												Classification EN 1993-1-1: 2005						A913	
	eje fuerte y-y strong axis y-y asse forte y-y					eje débil z-z weak axis z-z asse debole z-z					Pure bending y-y			Pure compression						
	G	I_y	$W_{el,y}$	W_{ply} ♦	i_y	A_v	I_z	$W_{el,z}$	$W_{pl,z}$ ♦	i_z	s_s	I_t	I_w	S235	S355	S460	S235	S355		S460
lbs/ft	mm ⁴ x10 ⁴	mm ³ x10 ³	mm ³ x10 ³	mm x10	mm ² x10 ²	mm ⁴ x10 ⁴	mm ³ x10 ³	mm ³ x10 ³	mm x10	mm	mm ⁴ x10 ⁴	mm ⁶ x10 ⁹								
W 16 x 7 x 36	36	18600	922,9	1045	16,54	32,41	1009	114,0	176,6	3,85	41,01	22,75	387,2	1	1	2	4	4	4	✓
W 16 x 7 x 40	40	21570	1060	1194	16,87	33,77	1205	135,4	209,0	3,99	45,02	32,81	467,4	1	1	1	4	4	4	✓
W 16 x 7 x 45	45	24530	1196	1354	16,91	38,39	1379	154,1	238,6	4,01	49,28	46,90	538,5	1	1	1	3	4	4	✓
W 16 x 7 x 50	50	27460	1330	1510	16,98	42,37	1559	173,2	268,7	4,05	53,37	63,79	612,8	1	1	1	2	4	4	✓
W 16 x 7 x 57	57	31530	1512	1725	17,06	48,05	1803	199,3	310,1	4,08	59,04	93,24	715,2	1	1	1	2	3	4	✓
W 16 x 10.25 x 67	67	39760	1916	2129	17,70	44,05	4954	381,1	581,4	6,25	55,52	99,70	1961	1	1	-	2	4	-	✓
W 16 x 10.25 x 77	77	46140	2197	2456	17,79	51,20	5725	438,7	670,9	6,27	61,92	149,4	2296	1	1	-	1	3	-	✓
W 16 x 10.25 x 89	89	53830	2533	2850	17,89	58,87	6739	512,5	785,4	6,33	69,42	227,1	2730	1	1	-	1	2	-	✓
W 16 x 10.25 x 100	100	61840	2870	3247	18,04	66,35	7765	586,1	899,8	6,39	76,62	324,1	3195	1	1	-	1	1	-	✓
W 18 x 6 x 35	35	21200	942	1088	17,89	36,40	634,0	83,43	131,5	3,09	40,92	21,24	304,8	1	1	2	4	4	4	✓
W 18 x 6 x 40	40	25480	1120	1284	18,33	38,85	796,1	104,1	163,1	3,24	46,32	33,58	387,2	1	1	1	4	4	4	✓
W 18 x 6 x 46	46	29680	1293	1487	18,44	44,31	940,5	122,1	192,1	3,28	51,62	51,07	461,2	1	1	1	4	4	4	✓
W 18 x 7.5 x 50	50	33260	1456	1650	18,75	43,67	1661	174,8	271,0	4,19	49,74	52,03	811,4	1	1	1	4	4	4	✓
W 18 x 7.5 x 55	55	37000	1608	1829	18,83	48,06	1862	195,0	303,0	4,22	53,63	69,55	915,7	1	1	1	3	4	4	✓
W 18 x 7.5 x 60	60	40960	1769	2013	18,96	51,33	2093	218,0	338,8	4,29	57,66	91,36	1035	1	1	1	3	4	4	✓
W 18 x 7.5 x 65	65	44680	1917	2189	19,02	55,76	2282	237,8	370,4	4,31	61,35	113,9	1137	1	1	1	2	4	4	✓
W 18 x 7.5 x 71	71	48790	2081	2385	19,04	61,34	2515	259,2	405,3	4,32	65,49	146,6	1260	1	1	1	1	3	4	✓
W 18 x 11 x 76	76	55600	2402	2673	19,65	52,45	6335	452,5	691,3	6,63	57,12	118,8	3143	1	1	-	2	4	-	✓
W 18 x 11 x 86	86	63690	2728	3049	19,73	59,32	7333	520,1	795,9	6,70	63,11	172,6	3666	1	1	-	2	3	-	✓
W 18 x 11 x 97	97	72600	3076	3454	19,86	66,42	8358	590,7	905,5	6,74	69,51	245,5	4224	1	1	-	1	2	-	✓
W 18 x 11 x 106	106	79620	3346	3774	19,91	73,41	9137	643,5	988,7	6,75	74,51	314,1	4662	1	1	-	1	2	-	✓
W 18 x 11 x 119	119	91040	3777	4282	20,07	81,97	10510	734,7	1131	6,82	82,16	445,2	5431	1	1	-	1	1	-	✓
W 18 x 11 x 130	130	102400	4186	4754	20,39	84,90	11540	815,5	1253	6,85	89,72	607,3	6055	1	1	-	1	1	-	✓
W 18 x 11 x 143	143	114300	4619	5272	20,54	92,94	12950	908,7	1398	6,91	97,22	803,3	6882	1	1	-	1	1	-	✓
W 18 x 11 x 158	158	127300	5083	5839	20,63	103,8	14450	1007	1554	6,95	105,5	1059	7775	1	1	-	1	1	-	✓
W 18 x 11 x 175	175	143700	5646	6525	20,83	114,8	16300	1128	1743	7,01	115,1	1423	8922	1	1	-	1	1	-	✓

♦ W_{pl} : para el diseño plástico la sección debe pertenecer a la clase 1 o 2 según la capacidad de rotación que se precise. Véase pág. 203.

♦ W_{pl} : for plastic design, the shape must belong to class 1 or 2 according to the required rotation capacity. See page 203.

♦ W_{pl} : per il calcolo plastico, la sezione trasversale deve appartenere alla classe 1 o 2, conformemente alla capacità di rotazione richiesta. Vedere pagina 203.

Perfiles americanos de alas paralelas (continúa)

Dimensiones: ASTM A 6/A 6M - 07

Tolerancias: ASTM A 6/A 6M - 07

Estado de la superficie: conforme a ASTM A 6/A 6M - 07

American wide flange beams (continued)

Dimensions: ASTM A 6/A 6M - 07

Tolerances: ASTM A 6/A 6M - 07

Surface condition: according to ASTM A 6/A 6M - 07

Profili I ad ali parallele (continua)

Dimensioni: ASTM A 6/A 6M - 07

Tolleranze: ASTM A 6/A 6M - 07

Condizioni di superficie: conformi ad ASTM A 6/A 6M - 07

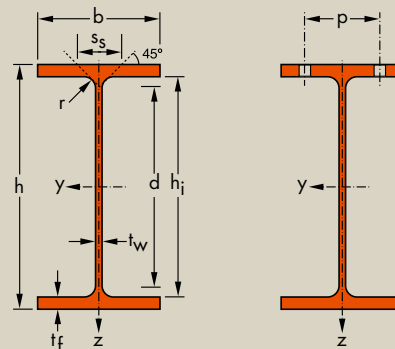

Denominación Designation Designazione (metric)	G kg/m	Dimensiones Dimensions Dimensioni					A mm ² x10 ²	Dimensiones de construcción Dimensions for detailing Dimensioni di dettaglio					Superficie Surface Superficie	
		h mm	b mm	t _w mm	t _f mm	r mm		h _i mm	d mm	Ø mm	p _{min} mm	p _{max} mm	A _L m ² /m	A _G m ² /t
W 530 x 165 x 66*	66,0	525	165	8,9	11,4	13	83,77	502,2	476,2	M22	89	93	1,670	25,39
W 530 x 165 x 74*	74,0	529	166	9,7	13,6	13	95,28	501,8	475,8	M22	90	94	1,680	22,47
W 530 x 165 x 85*	85,0	535	166	10,3	16,5	13	107,9	502	476	M22	90	94	1,691	19,96
W 530 x 210 x 92*	92,0	533	209	10,2	15,6	13	117,8	501,8	475,8	M27	94	104	1,859	20,10
W 530 x 210 x 101*	101	537	210	10,9	17,4	13	129,3	502,2	476,2	M27	94	104	1,870	18,43
W 530 x 210 x 109*	109	539	211	11,6	18,8	13	138,9	501,4	475,4	M27	96	106	1,876	17,20
W 530 x 210 x 123*	123	544	212	13,1	21,2	13	157,0	501,6	475,6	M27	96	106	1,887	15,31
W 530 x 210 x 138*	138	549	214	14,7	23,6	13	176,2	501,8	475,8	M27	98	108	1,902	13,75
W 610 x 180 x 82*	82,0	599	178	10,0	12,8	13	104,4	573,4	547,4	M24	90	100	1,868	22,80
W 610 x 180 x 92*	92,0	603	179	10,9	15,0	13	117,6	573,0	547,0	M24	91	101	1,878	20,34
W 610 x 230 x 101*	101	603	228	10,5	14,9	13	129,6	573,2	547,2	M27	94	122	2,075	20,40
W 610 x 230 x 113*	113	608	228	11,2	17,3	13	144,6	573,4	547,4	M27	94	122	2,083	18,36
W 610 x 230 x 125*	125	612	229	11,9	19,6	13	159,4	572,8	546,8	M27	96	124	2,094	16,74
W 610 x 230 x 140*	140	617	230	13,1	22,2	13	178,6	572,6	546,6	M27	96	124	2,105	15,02
W 610 x 230 x 153*	153	623	229	14,0	24,9	13	195,7	573,2	547,2	M27	94	139	2,112	13,74

* Pedido mínimo: 40 t por perfil y calidad o según acuerdo.

* Minimum order: 40t per section and grade or upon agreement.

* Ordine minimo: 40t per sezione e qualità o da concordare.



Páginas de notaciones 199-203 / Notations pages 199-203 / Pagine di annotazioni 199-203

Denominación Designation Designazione (imperial)	Propiedades de perfil / Section properties / Proprietà geometriche del profilo												Classification EN 1993-1-1: 2005						A913	
	eje fuerte y-y strong axis y-y asse forte y-y						eje débil z-z weak axis z-z asse debole z-z						Pure bending y-y			Pure compression				
	G	I_y	$W_{el,y}$	W_{ply} ♦	i_y	A_z	I_z	$W_{el,z}$	$W_{pl,z}$ ♦	i_z	s_s	I_t	I_w	S235	S355	S460	S235	S355		S460
lbs/ft	mm ⁴ x10 ⁴	mm ³ x10 ³	mm ³ x10 ³	mm x10	mm ² x10 ²	mm ⁴ x10 ⁴	mm ³ x10 ³	mm ³ x10 ³	mm x10	mm	mm ⁴ x10 ⁴	mm ⁶ x10 ⁹								
W 21 x 6.5 x 44	44	35100	1337	1563	20,47	50,13	857,3	103,9	166,2	3,20	46,93	33,29	562,9	1	1	-	4	4	-	✓
W 21 x 6.5 x 50	50	41100	1554	1810	20,77	54,98	1042	125,5	200,3	3,31	52,13	49,20	688,6	1	1	-	4	4	-	✓
W 21 x 6.5 x 57	57	48580	1816	2105	21,22	59,15	1264	152,2	241,8	3,42	58,53	74,55	845,5	1	1	-	4	4	-	✓
W 21 x 8.25 x 62	62	55240	2073	2362	21,67	58,07	2379	227,7	354,8	4,50	56,59	76,96	1589	1	1	1	4	4	4	✓
W 21 x 8.25 x 68	68	61760	2300	2623	21,85	62,72	2692	256,4	399,9	4,56	60,95	102,9	1813	1	1	1	4	4	4	✓
W 21 x 8.25 x 73	73	66730	2476	2826	21,93	66,47	2951	279,7	436,5	4,61	64,39	127,4	1991	1	1	1	3	4	4	✓
W 21 x 8.25 x 83	83	76100	2798	3208	22,02	75,34	3377	318,6	499,2	4,64	70,71	182,3	2300	1	1	1	2	4	4	✓
W 21 x 8.25 x 93	93	86160	3139	3617	22,10	84,98	3870	361,7	569,1	4,68	77,16	254,0	2660	1	1	1	1	3	4	✓
W 24 x 7 x 55	55	56030	1871	2199	23,17	63,40	1209	135,8	218,3	3,40	50,83	50,58	1034	1	1	-	4	4	-	✓
W 24 x 7 x 62	62	64680	2145	2515	23,45	69,44	1441	161,0	258,5	3,50	56,13	72,81	1239	1	1	-	4	4	-	✓
W 24 x 9 x 68	68	76470	2536	2905	24,27	67,31	2950	258,8	404,4	4,77	55,57	79,88	2545	1	1	-	4	4	-	✓
W 24 x 9 x 76	76	87570	2881	3290	24,62	71,99	3425	300,5	468,8	4,87	61,01	113,3	2981	1	1	-	4	4	-	✓
W 24 x 9 x 84	84	98650	3224	3679	24,86	77,28	3932	343,4	535,6	4,96	66,37	156,0	3442	1	1	1	4	4	4	✓
W 24 x 9 x 94	94	112000	3630	4150	25,05	85,02	4514	392,5	613,1	5,03	72,71	220,0	3982	1	1	1	3	4	4	✓
W 24 x 9 x 103	103	125200	4019	4602	25,29	91,66	4998	436,5	682,4	5,05	79,03	297,5	4457	1	1	1	3	4	4	✓

♦ W_{pl} : para el diseño plástico la sección debe pertenecer a la clase 1 o 2 según la capacidad de rotación que se precise. Véase pág. 203.

♦ W_{pl} : for plastic design, the shape must belong to class 1 or 2 according to the required rotation capacity. See page 203.

♦ W_{pl} : per il calcolo plastico, la sezione trasversale deve appartenere alla classe 1 o 2, conformemente alla capacità di rotazione richiesta. Vedere pagina 203.

Perfiles americanos de alas paralelas (continúa)

Dimensiones: ASTM A 6/A 6M - 07

Tolerancias: ASTM A 6/A 6M - 07

Estado de la superficie: conforme a ASTM A 6/A 6M - 07

American wide flange beams (continued)

Dimensions: ASTM A 6/A 6M - 07

Tolerances: ASTM A 6/A 6M - 07

Surface condition: according to ASTM A 6/A 6M - 07

Profili I ad ali parallele (continua)

Dimensioni: ASTM A 6/A 6M - 07

Tolleranze: ASTM A 6/A 6M - 07

Condizioni di superficie: conformi ad ASTM A 6/A 6M - 07

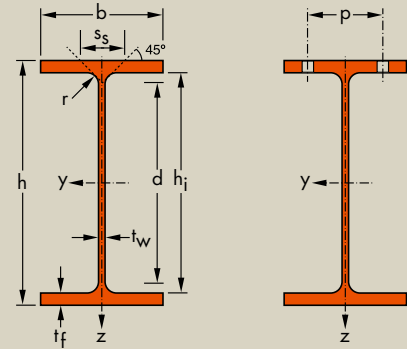

Denominación Designation Designazione (metric)	G kg/m	Dimensiones Dimensions Dimensioni					A mm ² x10 ²	Dimensiones de construcción Dimensions for detailing Dimensioni di dettaglio					Superficie Surface Superficie	
		h mm	b mm	t _w mm	t _f mm	r mm		h _i mm	d mm	Ø mm	p _{min} mm	p _{max} mm	A _L m ² /m	A _C m ² /t
W 610 x 325 x 155* [♣]	155	611	324	12,7	19,0	13	197,3	573,0	547,0	M27	96	218	2,470	15,95
W 610 x 325 x 174*	174	616	325	14,0	21,6	13	222,0	572,8	546,8	M27	98	220	2,482	14,24
W 610 x 325 x 195*	195	622	327	15,4	24,4	13	249,3	573,2	547,2	M27	98	222	2,499	12,77
W 610 x 325 x 217*	217	628	328	16,5	27,7	13	277,6	572,6	546,6	M27	100	222	2,513	11,53
W 610 x 325 x 241	241	635	329	17,9	31,0	13	308,0	573,0	547,0	M27	100	224	2,528	10,46
W 610 x 325 x 262*	262	641	327	19,0	34,0	13	332,7	573,0	547,0	M27	102	222	2,530	9,687
W 610 x 325 x 285*	285	647	329	20,6	37,1	13	363,6	572,8	546,8	M27	104	224	2,546	8,923
W 610 x 325 x 341*	341	661	333	24,4	43,9	13	433,7	573,2	547,2	M27	108	228	2,583	7,587
W 610 x 325 x 415*	415	679	338	29,5	53,1	13	529,4	572,8	546,8	M27	114	232	2,629	6,326
W 610 x 325 x 455*	455	689	340	32,0	57,9	13	578,6	573,2	547,2	M27	116	234	2,652	5,838
W 610 x 325 x 498*	498	699	343	35,1	63,0	13	634,8	573,0	547,0	M27	120	238	2,677	5,373
W 610 x 325 x 551	551	711	347	38,6	69,1	13	702,1	572,8	546,8	M27	122	242	2,710	4,918
W 690 x 250 x 125*	125	678	253	11,7	16,3	15	159,9	645,4	615,4	M27	100	148	2,319	18,47
W 690 x 250 x 140*	140	684	254	12,4	18,9	15	178,1	646,2	616,2	M27	100	148	2,333	16,69
W 690 x 250 x 152*	152	688	254	13,1	21,1	15	193,7	645,8	615,8	M27	102	148	2,340	15,39
W 690 x 250 x 170*	170	693	256	14,5	23,6	15	216,4	645,8	615,8	M27	102	150	2,355	13,86
W 690 x 250 x 192*	192	702	254	15,5	27,9	15	243,8	646,2	616,2	M27	104	148	2,363	12,35
W 760 x 265 x 147*	147	753	265	13,2	17,0	17	187,5	719,0	685,0	M27	106	160	2,510	17,06
W 760 x 265 x 161*	161	758	266	13,8	19,3	17	204,4	719,4	685,4	M27	106	160	2,523	15,72
W 760 x 265 x 173*	173	762	267	14,4	21,6	17	221,3	718,8	684,8	M27	106	162	2,534	14,58
W 760 x 265 x 185*	185	766	267	14,9	23,6	17	235,6	718,8	684,8	M27	106	162	2,541	13,74
W 760 x 265 x 196*	196	770	268	15,6	25,4	17	250,8	719,2	685,2	M27	108	162	2,552	12,96
W 760 x 265 x 220*	220	779	266	16,5	30,0	17	280,7	719,0	685,0	M27	108	160	2,560	11,62
W 840 x 295 x 176*	176	835	292	14,0	18,8	18	224,2	797,4	761,4	M27	108	186	2,779	15,79
W 840 x 295 x 193*	193	840	292	14,7	21,7	18	246,6	796,6	760,6	M27	108	186	2,788	14,40
W 840 x 295 x 210*	210	846	293	15,4	24,4	18	268,5	797,2	761,2	M27	110	188	2,802	13,29
W 840 x 295 x 226*	226	851	294	16,1	26,8	18	288,7	797,4	761,4	M27	110	188	2,815	12,42
W 840 x 295 x 251*	251	859	292	17,0	31,0	18	319,3	797,0	761,0	M27	112	186	2,821	11,25

* Pedido mínimo: 40 t por perfil y calidad o según acuerdo.

♣ Perfil canadiense, el tonelaje mínimo y las condiciones de suministro requieren un acuerdo previo.

* Minimum order: 40t per section and grade or upon agreement.

♣ Canadian section, minimum tonnage and delivery conditions upon agreement.

* Ordine minimo: 40t per sezione e qualità o da concordare.

♣ Profili canadesi, tonnellaggio minimo e condizioni di fornitura secondo accordi.



Páginas de notaciones 199-203 / Notations pages 199-203 / Pagine di annotazioni 199-203

Denominación Designation Designazione (imperial)	Propiedades de perfil / Section properties / Proprietà geometriche del profilo												Classification EN 1993-1-1: 2005						A913	
	eje fuerte y-y strong axis y-y asse forte y-y					eje débil z-z weak axis z-z asse debole z-z					Pure bending y-y			Pure compression						
	G lbs/ft	I_y mm ⁴ x10 ⁴	$W_{el,y}$ mm ³ x10 ³	W_{ply} ◆ mm ³ x10 ³	i_y mm x10	A_v mm ² x10 ²	I_z mm ⁴ x10 ⁴	$W_{el,z}$ mm ³ x10 ³	$W_{pl,z}$ ◆ mm ³ x10 ³	i_z mm x10	s_s mm	I_t mm ⁴ x10 ⁴	I_w mm ⁶ x10 ⁹	S235	S355	S460	S235	S355		S460
W 24 x 12.75 x 104 104	129000	4222	4728	25,57	81,57	10780	666,0	1022	7,39	65,93	197,7	9437	1	2	3	4	4	4	✓	✓
W 24 x 12.75 x 117 117	147200	4778	5362	25,74	90,28	12370	761,0	1170	7,46	72,43	283,2	10920	1	1	2	3	4	4	✓	✓
W 24 x 12.75 x 131 131	167900	5398	6074	25,95	99,83	14240	871,0	1340	7,56	79,43	400,9	12700	1	1	1	2	4	4	✓	✓
W 24 x 12.75 x 146 146	190800	6076	6848	26,21	107,7	16310	995,0	1531	7,67	87,13	564,6	14680	1	1	1	2	3	4	✓	✓
W 24 x 12.75 x 162 162	215400	6785	7671	26,45	117,6	18430	1120	1725	7,74	95,13	776,5	16780	1	1	1	1	3	4	✓	✓
W 24 x 12.75 x 176 176	236000	7363	8349	26,63	125,6	19850	1214	1871	7,72	102,2	998,1	18250	1	1	1	1	2	3	✓	✓
W 24 x 12.75 x 192 192	260700	8059	9175	26,78	136,7	22060	1341	2071	7,79	110,0	1295	20480	1	1	1	1	1	2	✓	✓
W 24 x 12.75 x 229 229	318300	9630	11070	27,09	163,4	27090	1627	2522	7,90	127,4	2153	25720	1	1	1	1	1	1	✓	✓
W 24 x 12.75 x 279 279	399800	11780	13690	27,48	199,9	34300	2030	3160	8,05	150,9	3824	33470	1	1	1	1	1	1	✓	✓
W 24 x 12.75 x 306 306	444500	12903	15093	27,72	218,5	38090	2241	3496	8,11	163,0	4948	37770	1	1	1	1	1	1	✓	✓
W 24 x 12.75 x 335 335	494700	14150	16670	27,92	241,1	42580	2483	3885	8,19	176,3	6420	42850	1	1	1	1	1	1	✓	✓
W 24 x 12.75 x 370 370	557500	15682	18599	28,18	267,2	48400	2790	4377	8,30	192,0	8525	49570	1	1	1	1	1	1	✓	✓
W 27 x 10 x 84 84	118500	3495	4009	27,22	84,24	4410	348,6	545,5	5,25	61,87	119,4	4816	1	1	-	4	4	-	✓	
W 27 x 10 x 94 94	136100	3979	4549	27,64	90,07	5174	407,4	636,4	5,39	67,77	168,4	5709	1	1	-	4	4	-	✓	
W 27 x 10 x 102 102	150600	4378	5002	27,88	95,63	5777	454,9	710,3	5,46	72,87	221,4	6408	1	1	1	4	4	4	✓	✓
W 27 x 10 x 114 114	169900	4904	5618	28,02	106,1	6618	517,0	809,3	5,53	79,27	306,7	7393	1	1	1	4	4	4	✓	✓
W 27 x 10 x 129 129	197900	5639	6457	28,49	114,8	7643	601,8	941,0	5,60	88,87	463,2	8657	1	1	1	3	4	4	✓	✓
W 30 x 10.5 x 99 99	166100	4411	5110	29,76	105,4	5289	399,2	630,8	5,31	67,12	161,5	7141	1	1	-	4	4	-	✓	
W 30 x 10.5 x 108 108	186100	4909	5666	30,17	111,0	6070	456,6	719,7	5,45	72,32	211,7	8259	1	1	1	4	4	4	✓	✓
W 30 x 10.5 x 116 116	205800	5402	6218	30,49	116,4	6873	514,9	809,9	5,57	77,52	273,6	9391	1	1	1	4	4	4	✓	✓
W 30 x 10.5 x 124 124	223000	5821	6691	30,76	121,1	7510	562,5	883,9	5,65	82,02	336,7	10320	1	1	1	4	4	4	✓	✓
W 30 x 10.5 x 132 132	240300	6241	7174	30,95	127,3	8175	610,1	958,8	5,71	86,32	408,9	11290	1	1	1	4	4	4	✓	✓
W 30 x 10.5 x 148 148	278200	7143	8198	31,48	136,3	9440	709,9	1113	5,80	96,42	609,0	13200	1	1	1	3	4	4	✓	✓
W 33 x 11.5 x 118 118	246400	5901	6816	33,15	123,8	7823	535,8	843,6	5,91	72,69	226,9	12990	1	1	-	4	4	-	✓	
W 33 x 11.5 x 130 130	278400	6630	7627	33,60	130,9	9029	618,5	971,3	6,05	79,19	309,9	15070	1	1	2	4	4	4	✓	✓
W 33 x 11.5 x 141 141	310700	7346	8430	34,02	138,1	10260	700,2	1098	6,18	85,29	409,0	17260	1	1	1	4	4	4	✓	✓
W 33 x 11.5 x 152 152	340100	7992	9163	34,32	145,1	11380	774,3	1213	6,28	90,79	517,5	19280	1	1	1	4	4	4	✓	✓
W 33 x 11.5 x 169 169	386500	8999	10300	34,79	154,7	12900	883,6	1383	6,36	100,1	737,6	22050	1	1	1	4	4	4	✓	✓

◆ W_{pl} : para el diseño plástico la sección debe pertenecer a la clase 1 o 2 según la capacidad de rotación que se precise. Véase pág. 203.

◆ W_{pl} : for plastic design, the shape must belong to class 1 or 2 according to the required rotation capacity. See page 203.

◆ W_{pl} : per il calcolo plastico, la sezione trasversale deve appartenere alla classe 1 o 2, conformemente alla capacità di rotazione richiesta. Vedere pagina 203.

Perfiles americanos de alas paralelas (continúa)

Dimensiones: ASTM A 6/A 6M - 07

Tolerancias: ASTM A 6/A 6M - 07

Estado de la superficie: conforme a ASTM A 6/A 6M - 07

American wide flange beams (continued)

Dimensions: ASTM A 6/A 6M - 07

Tolerances: ASTM A 6/A 6M - 07

Surface condition: according to ASTM A 6/A 6M - 07

Profili I ad ali parallele (continua)

Dimensioni: ASTM A 6/A 6M - 07

Tolleranze: ASTM A 6/A 6M - 07

Condizioni di superficie: conformi ad ASTM A 6/A 6M - 07

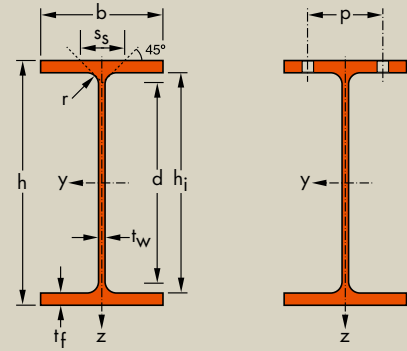

Denominación Designation Designazione (metric)	G kg/m	Dimensiones Dimensions Dimensioni					A mm ² x10 ²	Dimensiones de construcción Dimensions for detailing Dimensioni di dettaglio					Superficie Surface Superficie	
		h mm	b mm	t _w mm	t _f mm	r mm		h _i mm	d mm	Ø mm	p _{min} mm	p _{max} mm	A _L m ² /m	A _C m ² /t
W 920 x 310 x 201*	201	903	304	15,2	20,1	19	256,5	862,8	824,8	M27	112	198	2,959	14,70
W 920 x 310 x 223*	223	911	304	15,9	23,9	19	285,7	863,2	825,2	M27	112	198	2,974	13,26
W 920 x 310 x 238*	238	915	305	16,5	25,9	19	303,5	863,2	825,2	M27	112	200	2,984	12,53
W 920 x 310 x 253*	253	919	306	17,3	27,9	19	323,2	863,2	825,2	M27	114	200	2,995	11,80
W 920 x 310 x 271*	271	923	307	18,4	30,0	19	346,1	863,0	825,0	M27	114	202	3,005	11,06
W 920 x 310 x 289*	289	927	308	19,4	32,0	19	367,6	863,0	825,0	M27	116	202	3,015	10,45
W 920 x 310 x 313*	313	932	309	21,1	34,5	19	398,4	863,0	825,0	M27	118	204	3,025	9,673
W 920 x 420 x 342*	342	912	418	19,3	32,0	24	436,1	848,0	800,0	M 27	126	312	3,416	9,978
W 920 x 420 x 365*	365	916	419	20,3	34,3	24	464,4	847,4	799,4	M 27	128	314	3,426	9,398
W 920 x 420 x 387*	387	921	420	21,3	36,6	24	493,0	847,8	799,8	M 27	128	314	3,438	8,885
W 920 x 420 x 417*	417	928	422	22,5	39,9	24	532,5	848,2	800,2	M 27	130	316	3,458	8,271
W 920 x 420 x 446*	446	933	423	24,0	42,7	24	569,6	847,6	799,6	M 27	130	318	3,469	7,758
W 920 x 420 x 488*	488	942	422	25,9	47,0	24	621,3	848,0	800,0	M 27	132	316	3,479	7,134
W 920 x 420 x 534*	534	950	425	28,4	51,1	24	680,1	847,8	799,8	M 27	136	320	3,502	6,560
W 920 x 420 x 585*	585	960	427	31,0	55,9	24	745,3	848,2	800,2	M 27	138	322	3,525	6,025
W 920 x 420 x 653*	653	972	431	34,5	62,0	24	831,9	848,0	800,0	M 27	144	320	3,558	5,448
W 920 x 420 x 784*	784	996	437	40,9	73,9	24	997,7	848,2	800,2	M 27	152	326	3,617	4,618
W 920 x 420 x 967*	967	1028	446	50,0	89,9	24	1231	848,2	800,2	M 27	160	334	3,699	3,828
W 920 x 420 x 344*	344	927	418	19,3	32,0	19	437,2	863,0	825,0	M 27	126	312	3,455	10,07
W 920 x 420 x 368*	368	931	419	20,3	34,3	19	465,6	862,4	824,4	M 27	128	314	3,465	9,480
W 920 x 420 x 390*	390	936	420	21,3	36,6	19	494,3	862,8	824,8	M 27	128	314	3,477	8,960
W 920 x 420 x 420*	420	943	422	22,5	39,9	19	534,1	863,2	825,2	M 27	130	316	3,496	8,340
W 920 x 420 x 449*	449	948	423	24,0	42,7	19	571,4	862,6	824,6	M 27	130	318	3,507	7,820
W 920 x 420 x 491*	491	957	422	25,9	47,0	19	623,3	863,0	825,0	M 27	132	316	3,518	7,189
W 920 x 420 x 537*	537	965	425	28,4	51,1	19	682,5	862,8	824,8	M 27	136	320	3,541	6,609
W 920 x 420 x 588*	588	975	427	31,0	55,9	19	748,1	863,2	825,2	M 27	138	322	3,563	6,068
W 920 x 420 x 656*	656	987	431	34,5	62,0	19	835,3	863,0	825,0	M 27	144	320	3,596	5,485
W 920 x 420 x 725*	725	999	434	38,1	68,1	19	922,9	862,8	824,8	M 27	148	323	3,625	5,004
W 920 x 420 x 787*	787	1011	437	40,9	73,9	19	1002	863,2	825,2	M 27	152	326	3,656	4,647
W 920 x 420 x 970*	970	1043	446	50,0	89,9	19	1237	863,2	825,2	M 27	160	334	3,737	3,850

* Pedido mínimo: 40 t por perfil y calidad o según acuerdo.

* Tonelaje mínimo y condiciones de suministro previo acuerdo

♣ Dimensiones conforme a norma ASTM A 6/A 6M - 03c

* Minimum order: 40t per section and grade or upon agreement.

* Minimum tonnage and delivery conditions upon agreement.

♣ Dimensions according to ASTM A 6/A 6M - 03c

* Ordine minimo: 40t per sezione e qualità o da concordare.

* Tonnellaggio minimo e condizioni di fornitura da concordare.

♣ Dimensioni conformi a ASTM A 6/A 6M - 03c



Páginas de notaciones 199-203 / Notations pages 199-203 / Pagine di annotazioni 199-203

Denominación Designation Designazione (imperial)	Propiedades de perfil / Section properties / Proprietà geometriche del profilo												Classification EN 1993-1-1: 2005						A913	
	eje fuerte y-y strong axis y-y asse forte y-y						eje débil z-z weak axis z-z asse debole z-z						Pure bending y-y			Pure compression				
	G lbs/ft	I_y mm ⁴ x10 ⁴	$W_{el,y}$ mm ³ x10 ³	$W_{pl,y} \blacklozenge$ mm ³ x10 ³	i_y mm x10	A_v mm ² x10 ²	I_z mm ⁴ x10 ⁴	$W_{el,z}$ mm ³ x10 ³	$W_{pl,z} \blacklozenge$ mm ³ x10 ³	i_z mm x10	s_s mm	I_t mm ⁴ x10 ⁴	I_w mm ⁶ x10 ⁹	S235	S355	S460	S235	S355		S460
W 36 x 12 x 135	135	325200	7203	8356	35,61	144,9	9442	621,2	982,3	6,07	77,66	298,0	18340	1	1	-	4	4	-	✓
W 36 x 12 x 150	150	376800	8273	9540	36,32	153,2	11220	738,5	1163	6,27	85,96	426,8	22020	1	1	2	4	4	4	✓
W 36 x 12 x 160	160	406400	8883	10230	36,59	159,6	12290	805,6	1267	6,36	90,56	518,8	24200	1	1	1	4	4	4	✓
W 36 x 12 x 170	170	437500	9520	10960	36,79	167,9	13370	873,6	1375	6,43	95,36	630,9	26450	1	1	1	4	4	4	✓
W 36 x 12 x 182	182	471600	10220	11780	36,91	178,8	14520	945,8	1491	6,48	100,7	775,0	28840	1	1	1	4	4	4	✓
W 36 x 12 x 194	194	504500	10880	12570	37,04	188,9	15640	1016	1603	6,52	105,7	929,8	31210	1	1	1	4	4	4	✓
W 36 x 12 x 210	210	548200	11760	13630	37,10	205,6	17040	1103	1748	6,54	112,4	1171	34160	1	1	1	3	4	4	✓
W 36 x 16.5 x 230	230	624900	13700	15450	37,85	190,1	39010	1867	2882	9,46	111,4	1193	75410	1	1	1	3	4	4	✓
W 36 x 16.5 x 245	245	670500	14640	16520	38,00	200,4	42120	2011	3106	9,52	117,0	1446	81730	1	1	1	3	4	4	✓
W 36 x 16.5 x 260	260	718300	15600	17630	38,17	210,9	45280	2156	3332	9,58	122,6	1734	88370	1	1	1	2	4	4	✓
W 36 x 16.5 x 280	280	787600	16970	19210	38,46	223,9	50070	2373	3668	9,70	130,4	2200	98540	1	1	1	2	4	4	✓
W 36 x 16.5 x 300	300	846800	18150	20600	38,56	239,1	53980	2552	3951	9,73	137,5	2685	106700	1	1	1	2	3	4	✓
W 36 x 16.5 x 328	328	935400	19860	22610	38,80	259,3	59010	2797	4336	9,75	148,0	3514	117900	1	1	1	1	2	4	✓
W 36 x 16.5 x 359	359	1031000	21710	24830	38,94	284,8	65560	3085	4796	9,82	158,7	4542	132100	1	1	1	1	2	3	✓
W 36 x 16.5 x 393	393	1143000	23810	27360	39,16	312,0	72770	3408	5310	9,88	170,9	5932	148200	1	1	1	1	1	2	✓
W 36 x 16.5 x 439	439	1292000	26590	30730	39,41	348,7	83050	3854	6022	9,99	186,6	8124	171300	1	1	1	1	1	1	✓
W 36 x 16.5 x 527	527	1593000	31980	37340	39,95	417,6	103300	4728	7424	10,18	216,8	13730	218500	1	1	-	1	1	-	✓
W 36 x 16.5 x 650	650	2033000	39540	46810	40,64	517,1	133900	6003	9486	10,43	257,9	24930	292400	1	1	-	1	1	-	✓
W 36 x 16.5 x 231	231	645000	13920	15700	38,41	188,0	39010	1867	2880	9,45	105,6	1159	78120	1	1	1	4	4	4	✓
W 36 x 16.5 x 247	247	692200	14870	16790	38,56	198,2	42120	2010	3104	9,51	111,2	1408	84670	1	1	1	3	4	4	✓
W 36 x 16.5 x 262	262	741700	15850	17920	38,74	208,6	45270	2156	3331	9,57	116,8	1691	91550	1	1	1	3	4	4	✓
W 36 x 16.5 x 282	282	813300	17250	19530	39,02	221,5	50070	2373	3667	9,68	124,6	2151	102100	1	1	1	2	4	4	✓
W 36 x 16.5 x 302	302	874700	18450	20950	39,13	236,6	53970	2552	3949	9,72	131,7	2627	110600	1	1	1	2	4	4	✓
W 36 x 16.5 x 330	330	966300	20200	23000	39,37	256,6	59000	2796	4335	9,73	142,2	3441	122200	1	1	1	1	3	4	✓
W 36 x 16.5 x 361	361	1066000	22080	25270	39,51	282,1	65550	3085	4795	9,80	152,9	4447	136900	1	1	1	1	2	3	✓
W 36 x 16.5 x 395	395	1181000	24230	27840	39,74	309,3	72760	3408	5310	9,86	165,1	5859	153200	1	1	1	1	1	2	✓
W 36 x 16.5 x 441	441	1335000	27060	31270	39,98	345,8	83040	3853	6022	9,97	180,8	7950	177600	1	1	1	1	1	2	✓
W 36 x 16.5 x 487	487	1492000	29880	34740	40,21	383,6	93200	4295	6734	10,05	196,6	10570	201900	1	1	1	1	1	1	✓
W 36 x 16.5 x 529	529	1646000	32560	38010	40,53	414,5	103300	4728	7425	10,15	211,0	13430	226800	1	1	1	1	1	1	✓
W 36 x 16.5 x 652	652	2100000	40270	47660	41,21	513,8	133900	6002	9490	10,40	252,1	24320	304000	1	1	1	1	1	1	✓

◆ W_{pl} : para el diseño plástico la sección debe pertenecer a la clase 1 o 2 según la capacidad de rotación que se precise. Véase pág. 203.

◆ W_{pl} : for plastic design, the shape must belong to class 1 or 2 according to the required rotation capacity. See page 203.

◆ W_{pl} : per il calcolo plastico, la sezione trasversale deve appartenere alla classe 1 o 2, conformemente alla capacità di rotazione richiesta. Vedere pagina 203.

Perfiles americanos de alas paralelas (continúa)

Dimensiones: ASTM A 6/A 6M - 07

Tolerancias: ASTM A 6/A 6M - 07

Estado de la superficie: conforme a ASTM A 6/A 6M - 07

American wide flange beams (continued)

Dimensions: ASTM A 6/A 6M - 07

Tolerances: ASTM A 6/A 6M - 07

Surface condition: according to ASTM A 6/A 6M - 07

Profili I ad ali parallele (continua)

Dimensioni: ASTM A 6/A 6M - 07

Tolleranze: ASTM A 6/A 6M - 07

Condizioni di superficie: conformi ad ASTM A 6/A 6M - 07

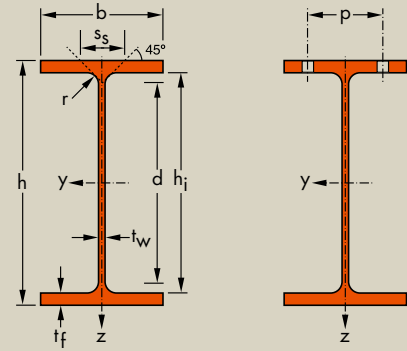

Denominación Designation Designazione (metric)	G kg/m	Dimensiones Dimensions Dimensioni					A mm ² x10 ²	Dimensiones de construcción Dimensions for detailing Dimensioni di dettaglio					Superficie Surface Superficie	
		h mm	b mm	t _w mm	t _f mm	r mm		h _i mm	d mm	Ø mm	p _{min} mm	p _{max} mm	A _L m ² /m	A _G m ² /t
W 1000 x 300 x 222*	222	970	300	16,0	21,1	30	282,8	928,0	868,0	M27	134	194	3,056	13,77
W 1000 x 300 x 249*	249	980	300	16,5	26,0	30	316,8	928,0	868,0	M27	134	194	3,075	12,37
W 1000 x 300 x 272*	272	990	300	16,5	31,0	30	346,8	928,0	868,0	M27	134	194	3,095	11,37
W 1000 x 300 x 314*	314	1000	300	19,1	35,9	30	400,4	928,0	868,0	M27	136	194	3,110	9,895
W 1000 x 300 x 350*	350	1008	302	21,1	40,0	30	445,1	928,0	868,0	M27	140	196	3,130	8,958
W 1000 x 300 x 393*	393	1016	303	24,4	43,9	30	500,2	928,0	868,0	M27	142	198	3,144	8,006
W 1000 x 300 x 415*	415	1020	304	26,0	46,0	30	528,7	928,0	868,0	M27	144	198	3,152	7,596
W 1000 x 300 x 438	438	1026	305	26,9	49,0	30	556,3	928,0	868,0	M27	146	200	3,167	7,252
W 1000 x 300 x 494*	494	1036	309	31,0	54,0	30	629,1	928,0	868,0	M27	148	204	3,194	6,468
W 1000 x 300 x 584*	584	1056	314	36,0	64,0	30	743,7	928,0	868,0	M27	154	208	3,244	5,557
W 1000 x 400 x 296*	296	982	400	16,5	27,1	30	377,6	928,0	868,0	M 27	134	294	3,479	11,74
W 1000 x 400 x 321*	321	990	400	16,5	31,0	30	408,8	928,0	868,0	M 27	134	294	3,495	10,89
W 1000 x 400 x 371*	371	1000	400	19,0	36,1	30	472,8	928,0	868,0	M 27	136	294	3,510	9,458
W 1000 x 400 x 412*	412	1008	402	21,1	40,0	30	525,1	928,0	868,0	M 27	140	296	3,530	8,564
W 1000 x 400 x 443*	443	1012	402	23,6	41,9	30	563,7	928,2	868,2	M 27	142	296	3,533	7,985
W 1000 x 400 x 483*	483	1020	404	25,4	46,0	30	615,1	928,0	868,0	M 27	144	298	3,554	7,360
W 1000 x 400 x 539*	539	1030	407	28,4	51,1	30	687,2	927,8	867,8	M 27	146	302	3,580	6,636
W 1000 x 400 x 554*	554	1032	408	29,5	52,0	30	705,8	928,0	868,0	M 27	150	296	3,585	6,471
W 1000 x 400 x 591*	591	1040	409	31,0	55,9	30	752,7	928,2	868,2	M 27	148	304	3,602	6,097
W 1000 x 400 x 642*	642	1048	412	34,0	60,0	30	817,6	928,0	868,0	M 27	154	300	3,624	5,647
W 1000 x 400 x 748*	748	1068	417	39,0	70,0	30	953,4	928,0	868,0	M 27	160	304	3,674	4,909
W 1000 x 400 x 883*	883	1092	424	45,5	82,0	30	1125	928,0	868,0	M 27	166	312	3,737	4,231
W 1100 x 400 x 343*	343	1090	400	18,0	31,0	20	436,5	1028	988,0	M 27	116	294	3,710	10,83
W 1100 x 400 x 390*	390	1100	400	20,0	36,0	20	497,0	1028	988,0	M 27	118	294	3,726	9,549
W 1100 x 400 x 433*	433	1108	402	22,0	40,0	20	551,2	1028	988,0	M 27	120	296	3,746	8,657
W 1100 x 400 x 499*	499	1118	405	26,0	45,0	20	635,2	1028	988,0	M 27	124	300	3,770	7,560

* Pedido mínimo: 40 t por perfil y calidad o según acuerdo.

* Minimum order: 40t per section and grade or upon agreement.

* Ordine minimo: 40t per sezione e qualità o da concordare.



Páginas de notaciones 199-203 / Notations pages 199-203 / Pagine di annotazioni 199-203

Denominación Designation Designazione (imperial)	Propiedades de perfil / Section properties / Proprietà geometriche del profilo												Classification EN 1993-1-1: 2005						A913	
	eje fuerte y-y strong axis y-y asse forte y-y						eje débil z-z weak axis z-z asse debole z-z						Pure bending y-y			Pure compression				
	G	I_y	$W_{el,y}$	$W_{pl,y} \blacklozenge$	i_y	A_v	I_z	$W_{el,z}$	$W_{pl,z} \blacklozenge$	i_z	s_s	I_t	I_w	S235	S355	S460	S235	S355		S460
lbs/ft	mm ⁴ x10 ⁴	mm ³ x10 ³	mm ³ x10 ³	mm x10	mm ² x10 ²	mm ⁴ x10 ⁴	mm ³ x10 ³	mm ³ x10 ³	mm x10	mm	mm ⁴ x10 ⁴	mm ⁶ x10 ⁹								
W 40 x 12 x 149	149	407700	8405	9803	37,97	172,2	9546	636,4	1020	5,81	93,35	406,0	21370	1	1	-	4	4	-	✓
W 40 x 12 x 167	167	481100	9818	11350	38,97	180,7	11750	783,6	1245	6,09	103,6	584,4	26620	1	1	2	4	4	4	✓
W 40 x 12 x 183	183	553800	11190	12820	39,96	184,6	14000	933,6	1470	6,35	113,6	822,4	32070	1	1	2	4	4	4	✓
W 40 x 12 x 211	211	644200	12880	14850	40,11	213,4	16230	1082	1713	6,37	126,0	1252	37540	1	1	1	4	4	4	✓
W 40 x 12 x 235	235	723000	14340	16590	40,30	236,0	18460	1223	1941	6,44	136,2	1707	43020	1	1	1	3	4	4	✓
W 40 x 12 x 264	264	807700	15900	18540	40,18	271,3	20500	1353	2168	6,40	147,3	2332	48080	1	1	1	2	4	4	✓
W 40 x 12 x 278	278	853100	16730	19570	40,17	288,6	21710	1428	2298	6,41	153,1	2713	51080	1	1	1	2	3	4	✓
W 40 x 12 x 294	294	909200	17720	20750	40,43	299,9	23360	1531	2463	6,48	160,0	3190	55290	1	1	1	1	3	4	✓
W 40 x 12 x 331	331	1028000	19840	23410	40,42	344,5	26820	1736	2818	6,53	174,1	4433	64010	1	1	1	1	2	3	✓
W 40 x 12 x 392	392	1246000	23600	28040	40,93	403,2	33430	2130	3475	6,70	199,1	7230	81240	1	1	1	1	1	2	✓
W 40 x 16 x 199	199	620300	12630	14260	40,53	181,5	28960	1448	2243	8,76	105,8	762,6	65900	1	1	2	4	4	4	✓
W 40 x 16 x 215	215	696400	14070	15800	41,27	184,6	33120	1656	2555	9,00	113,6	1021	76030	1	1	2	4	4	4	✓
W 40 x 16 x 249	249	813700	16270	18360	41,49	212,5	38580	1929	2984	9,03	126,3	1575	89440	1	1	1	4	4	4	✓
W 40 x 16 x 277	277	910500	18070	20460	41,64	236,0	43400	2160	3349	9,09	136,2	2134	101500	1	1	1	3	4	4	✓
W 40 x 16 x 297	297	966500	19100	21780	41,41	261,8	45500	2264	3529	8,98	142,5	2545	106700	1	1	1	2	4	4	✓
W 40 x 16 x 324	324	1067000	20930	23920	41,66	282,7	50710	2510	3919	9,08	152,5	3311	119900	1	1	1	2	4	4	✓
W 40 x 16 x 362	362	1203000	23350	26820	41,83	316,4	57630	2832	4436	9,16	165,7	4546	137600	1	1	1	1	2	4	✓
W 40 x 16 x 372	372	1232000	23880	27500	41,79	328,0	59100	2897	4547	9,15	168,6	4860	141300	1	1	1	1	2	3	✓
W 40 x 16 x 397	397	1331000	25600	29530	42,05	346,3	64010	3130	4916	9,22	177,9	5927	154300	1	1	1	1	2	3	✓
W 40 x 16 x 431	431	1451000	27680	32100	42,12	379,6	70280	3412	5379	9,27	189,1	7440	170700	1	1	1	1	1	2	✓
W 40 x 16 x 503	503	1732000	32430	37880	42,62	438,9	85110	4082	6459	9,45	214,1	11670	210600	1	1	1	1	1	1	✓
W 40 x 16 x 593	593	2096000	38390	45260	43,16	516,5	105000	4952	7874	9,66	244,6	18750	265700	1	1	-	1	1	-	✓
W 44 x 16 x 230	230	867400	15920	18060	44,58	206,5	33120	1656	2568	8,71	103,4	1037	92710	1	1	2	4	4	4	✓
W 44 x 16 x 262	262	1005000	18280	20780	44,98	230,6	38480	1924	2988	8,80	115,4	1564	108700	1	1	1	4	4	4	✓
W 44 x 16 x 290	290	1126000	20320	23160	45,19	254,4	43410	2160	3362	8,87	125,4	2130	123500	1	1	1	4	4	4	✓
W 44 x 16 x 335	335	1294000	23150	26600	45,14	300,4	49980	2468	3870	8,87	139,4	3135	143400	1	1	1	2	4	4	✓

◆ W_{pl} : para el diseño plástico la sección debe pertenecer a la clase 1 o 2 según la capacidad de rotación que se precise. Véase pág. 203.

◆ W_{pl} : for plastic design, the shape must belong to class 1 or 2 according to the required rotation capacity. See page 203.

◆ W_{pl} : per il calcolo plastico, la sezione trasversale deve appartenere alla classe 1 o 2, conformemente alla capacità di rotazione richiesta. Vedere pagina 203.

Perfiles I americanos de alas inclinadas

Dimensiones: ASTM A 6/A 6M - 07
 Tolerancias: ASTM A 6/A 6M - 07
 Estado de la superficie: conforme a ASTM A 6/A 6M - 07
 Inclinación de las alas: 1/6

American standard beams

Dimensions: ASTM A 6/A 6M - 07
 Tolerances: ASTM A 6/A 6M - 07
 Surface condition: according to ASTM A 6/A 6M - 07
 Flange slope: 1/6

Profili I ad ali inclinate

Dimensioni: ASTM A 6/A 6M - 07
 Tolleranze: ASTM A 6/A 6M - 07
 Condizioni di superficie: conformi ad ASTM A 6/A 6M - 07
 Inclinazione dell'ala: 1/6

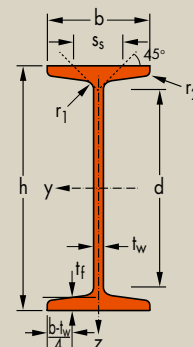

Denominación Designation Designazione (metric)	Dimensiones Dimensions Dimensioni								Superficie Surface Superficie		
	G kg/m	h mm	b mm	t _w mm	t _f mm	r ₁ mm	r ₂ mm	d mm	A mm ² x10 ²	A _L m ² /m	A _C m ² /t
S 75 x 8.5*	8,5	76	59	4,3	6,6	7,0	2,1	48	10,8	0,36	42,59
S 75 x 11.2*	11,2	76	64	8,9	6,6	7,0	3,8	48	14,3	0,37	33,44
S 100 x 11.5*	11,5	102	68	4,9	7,4	7,5	4,1	72	14,5	0,45	39,13
S 100 x 14.1*	14,1	102	71	8,3	7,4	7,5	4,8	72	18,0	0,45	32,26
S 130 x 15*	15,0	127	76	5,4	8,3	7,9	4,9	94	18,8	0,53	35,74
S 150 x 18.6*	18,6	152	85	5,9	9,1	7,9	4,9	117	23,6	0,61	32,94
S 150 x 25.7*	25,7	152	91	11,8	9,1	8,5	5,0	117	32,7	0,62	24,27
S 200 x 27.4*	27,4	203	102	6,9	10,8	8,5	5,0	164	34,8	0,77	28,26
S 200 x 34*	34,0	203	106	11,2	10,8	9,5	5,2	161	43,7	0,78	22,78
S 250 x 37.8*	37,8	254	118	7,9	12,5	10,5	6,0	207	48,1	0,93	24,72
S 250 x 52*	52,0	254	126	15,1	12,5	10,5	6,0	207	66,5	0,95	18,18
S 310 x 47.3*	47,3	305	127	8,9	13,8	11,5	6,5	254	60,3	1,07	22,52
S 310 x 52*	52,0	305	129	10,9	13,8	11,5	6,5	254	66,5	1,07	20,53
S 310 x 60.7*	60,7	305	133	11,7	16,7	14,0	6,5	243	77,4	1,08	17,85
S 310 x 74*	74,0	305	139	17,4	16,7	14,0	6,5	243	94,8	1,09	14,71
S 380 x 64*	64,0	381	140	10,4	15,8	13,0	6,5	322	81,3	1,26	19,76
S 380 x 74*	74,0	381	143	14,0	15,8	13,0	7,8	322	94,8	1,27	17,06
S 460 x 81.4*	81,4	457	152	11,7	17,6	14,5	9,0	392	104	1,46	17,94
S 460 x 104*	104	457	159	18,1	17,6	14,5	9,0	392	133	1,47	14,11
S 510 x 98*	98,0	508	159	12,8	20,2	15,0	9,4	437	125	1,59	16,17
S 510 x 112*	112	508	162	16,1	20,2	15,0	9,4	437	142	1,59	14,32
S 510 x 128*	128	516	179	16,8	23,4	15,0	9,4	437	163	1,67	13,01
S 510 x 143*	143	516	183	20,3	23,4	15,0	9,4	437	182	1,68	11,76
S 610 x 119*	119	610	178	12,7	22,1	15,5	9,6	534	152	1,86	15,65
S 610 x 134*	134	610	181	15,9	22,1	15,5	9,6	534	171	1,86	13,91
S 610 x 149*	149	610	184	18,9	22,1	15,5	9,6	534	189	1,87	12,60
S 610 x 158*	158	622	200	15,7	27,7	15,5	9,6	534	201	1,96	12,45
S 610 x 180*	180	622	204	20,3	27,7	15,5	9,6	534	230	1,97	10,95

* Tonelaje mínimo y condiciones de suministro previo acuerdo.

* Minimum tonnage and delivery conditions upon agreement.

* Tonnellaggio minimo e condizioni di fornitura da concordare.

Denominación Designation Designazione (imperial)	Propiedades de perfil / Section properties / Proprietà geometriche del profilo													Classification EN 1993-1-1: 2005				A572/A709/A992
	eje fuerte y-y strong axis y-y asse forte y-y						eje débil z-z weak axis z-z asse debole z-z				Pure bending y-y		Pure compression					
	G lbs/ft	I_y mm ⁴ x10 ⁴	W_{ely} mm ³ x10 ³	$W_{ply}♦$ mm ³ x10 ³	i_y mm x10	A_z mm ² x10 ²	I_z mm ⁴ x10 ⁴	W_{elz} mm ³ x10 ³	$W_{plz}♦$ mm ³ x10 ³	i_z mm x10	s_s mm	I_t mm ⁴ x10 ⁴	I_w mm ⁶ x10 ⁹	S235	S355	S235	S355	
S 3 x 5.7	5,7	105	27,5	31,5	3,12	4,19	18,9	6,39	10,6	1,32	27,9	1,93	0,23	1	1	1	1	✓
S 3 x 7.5	7,5	121	31,9	38,2	2,92	7,23	24,3	7,59	13,6	1,31	32,6	4,97	0,29	1	1	1	1	✓
S 4 x 7.7	7,7	255	50,0	57,1	4,18	6,07	31,6	9,28	15,9	1,47	31,3	3,17	0,72	1	1	1	1	✓
S 4 x 9.5	9,5	283	55,5	65,5	3,97	9,16	36,3	10,2	18,4	1,42	34,6	5,91	0,82	1	1	1	1	✓
S 5 x 10	10,0	509	80,2	91,4	5,20	8,07	49,2	12,9	22,3	1,62	34,5	4,92	1,77	1	1	1	1	✓
S 6 x 12.5	12,5	913	120	137	6,22	10,20	75,5	17,8	30,6	1,79	37,3	7,14	3,92	1	1	1	1	✓
S 6 x 17.25	17,3	1089	143	171	5,78	18,54	95,9	21,1	38,9	1,71	43,7	18,5	4,87	1	1	1	1	✓
S 8 x 18.4	18,4	2390	236	268	8,29	15,46	156	30,5	52,4	2,11	43,6	14,1	14,5	1	1	1	1	✓
S 8 x 23	23,0	2691	265	313	7,86	23,84	178	33,6	60,5	2,02	48,7	25,4	16,4	1	1	1	1	✓
S 10 x 25.4	25,4	5127	404	461	10,3	22,30	279	47,2	81,3	2,41	50,9	25,8	41,1	1	1	1	1	✓
S 10 x 35	35,0	6139	483	579	9,61	39,22	349	55,5	103	2,29	58,1	61,2	50,6	1	1	1	1	✓
S 12 x 31.8	31,8	9082	596	684	12,3	29,77	386	60,8	105	2,53	56,0	38,5	82,9	1	1	1	2	✓
S 12 x 35	35,0	9555	627	730	12,0	35,47	408	63,2	112	2,48	58,0	47,4	87,1	1	1	1	1	✓
S 12 x 40.8	40,8	11310	742	862	12,1	39,25	560	84,2	145	2,69	66,9	75,6	117	1	1	1	1	✓
S 12 x 50	50,0	12680	832	996	11,6	55,25	652	93,9	169	2,63	72,7	130,0	134	1	1	1	1	✓
S 15 x 42.9	42,9	18620	977	1131	15,1	42,91	602	86,0	149	2,72	63,7	66,1	202	1	1	1	3	✓
S 15 x 50	50,0	20180	1059	1257	14,6	55,79	645	90,3	164	2,61	67,3	94,5	216	1	1	1	1	✓
S 18 x 54.7	54,7	33390	1461	1703	18,0	57,51	855	113	199	2,87	70,8	102	419	1	1	2	3	✓
S 18 x 70	70,0	38580	1689	2042	17,0	85,10	1002	126	238	2,74	77,2	190	483	1	1	1	1	✓
S 20 x 66	66,0	49450	1947	2275	19,9	69,41	1147	144	253	3,03	78,0	153	691	1	1	2	3	✓
S 20 x 75	75,0	52980	2086	2485	19,4	85,23	1226	151	274	2,94	81,2	200	734	1	1	1	2	✓
S 20 x 86	86,0	65480	2540	2990	20,0	90,18	1929	216	378	3,44	89,7	287	1173	1	1	1	1	✓
S 20 x 96	96,0	69620	2700	3228	19,6	107	2081	227	410	3,39	93,2	369	1256	1	1	1	1	✓
S 24 x 80	80,0	87530	2872	3336	24,1	82,5	1750	197	342	3,40	83,7	207	1528	1	1	4	4	✓
S 24 x 90	90,0	93500	3067	3631	23,4	101	1857	205	367	3,30	86,9	262	1612	1	1	2	3	✓
S 24 x 100	100	99160	3253	3910	22,9	118	1970	214	393	3,23	89,9	333	1698	1	1	1	2	✓
S 24 x 106	106	122300	3929	4560	24,7	103	3195	320	546	3,99	99,5	428	2837	1	1	2	3	✓
S 24 x 121	121	131200	4217	4996	23,9	129	3427	336	592	3,87	104	553	3022	1	1	1	1	✓

♦ W_{pl} : para el diseño plástico la sección debe pertenecer a la clase 1 o 2 según la capacidad de rotación que se precise. Véase pág. 203.

♦ W_{pl} : for plastic design, the shape must belong to class 1 or 2 according to the required rotation capacity. See page 203.

♦ W_{pl} : per il calcolo plastico, la sezione trasversale deve appartenere alla classe 1 o 2, conformemente alla capacità di rotazione richiesta. Vedere pagina 203.

Perfiles H americanos de alas anchas para pilotes

Dimensiones: ASTM A 6/A 6M - 07
Tolerancias: ASTM A 6/A 6M - 07
Estado de la superficie: conforme a ASTM A 6/A 6M - 07

American wide flange bearing piles

Dimensions: ASTM A 6/A 6M - 07
Tolerances: ASTM A 6/A 6M - 07
Surface condition: according to ASTM A 6/A 6M - 07

Profili H ad ali larghe

Dimensioni: ASTM A 6/A 6M - 07
Tolleranze: ASTM A 6/A 6M - 07
Condizioni di superficie: conformi ad ASTM A 6/A 6M - 07

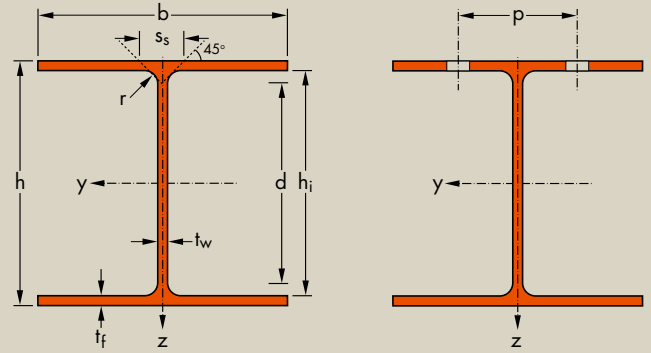

Denominación Designation Designazione (metric)	G kg/m	Dimensiones Dimensions Dimensioni					A mm ² x10 ²	Dimensiones de construcción Dimensions for detailing Dimensioni di dettaglio					Superficie Surface Superficie	
		h mm	b mm	t _w mm	t _r mm	r mm		h _i mm	d mm	Ø	p _{min} mm	p _{max} mm	A _L m ² /m	A _G m ² /t
HP 200 x 43*/*	43,0	200	205	9,0	9,0	10	54,14	182,0	162,0	M24	96	112	1,185	27,88
HP 200 x 53*	53,0	204	207	11,3	11,3	10	68,40	181,4	161,4	M24	98	114	1,196	22,36
HP 250 x 62*	62,0	246	256	10,5	10,7	13	80,00	224,6	198,6	M27	104	150	1,473	23,50
HP 250 x 85*	85,0	254	260	14,4	14,4	13	108,0	225,2	199,2	M27	108	154	1,497	17,53
HP 310 x 79*	79,0	299	306	11,0	11,0	15	100,0	277,0	247,0	M27	104	200	1,774	22,67
HP 310 x 93*	93,0	303	308	13,1	13,1	15	119,0	276,8	246,8	M27	106	202	1,786	19,14
HP 310 x 110*	110	308	310	15,4	15,5	15	141,0	277,0	247,0	M27	108	204	1,799	16,29
HP 310 x 125*	125	312	312	17,4	17,4	15	159,0	277,2	247,2	M27	110	206	1,811	14,54
HP 310 x 132*/*	132	314	313	18,3	18,3	15	167,3	277,4	247,4	M27	112	208	1,818	13,84
HP 360 x 108*	108	346	370	12,8	12,8	15	138,0	320,4	290,4	M27	102	264	2,121	19,62
HP 360 x 132*	132	351	373	15,6	15,6	15	168,0	319,8	289,8	M27	104	268	2,137	16,19
HP 360 x 152*	152	356	376	17,9	17,9	15	194,0	320,2	290,2	M27	106	270	2,154	14,16
HP 360 x 174*	174	361	378	20,4	20,4	15	222,0	320,2	290,2	M27	110	272	2,167	12,47

♣ Perfil anterior.
* Pedido mínimo: 40 t por perfil y calidad o según acuerdo.
* Tonelaje mínimo y condiciones de suministro previo acuerdo.

♣ Previous section.
* Minimum order: 40t per section and grade or upon agreement.
* Minimum tonnage and delivery conditions upon agreement.

♣ Sezione precedente
* Ordine minimo: 40t per sezione e qualità o da concordare.
* Tonnellaggio minimo e condizioni di fornitura da concordare.

Páginas de notaciones 199-203 / Notations pages 199-203 / Pagine di annotazioni 199-203

Denominación Designation Designazione (imperial)	Propiedades de perfil / Section properties / Proprietà geometriche del profilo												Classification EN 1993-1-1: 2005						A913	
	eje fuerte y-y strong axis y-y asse forte y-y						eje débil z-z weak axis z-z asse debole z-z						Pure bending y-y			Pure compression				
	G	I_y	$W_{el,y}$	$W_{pl,y} \blacklozenge$	i_y	A_z	I_z	$W_{el,z}$	$W_{pl,z} \blacklozenge$	i_z	s_s	I_t	I_w	S235	S355	S460	S235	S355		S460
lbs/ft	mm ⁴ x10 ⁴	mm ³ x10 ³	mm ³ x10 ³	mm x10	mm ² x10 ²	mm ⁴ x10 ⁴	mm ³ x10 ³	mm ³ x10 ³	mm x10	mm	mm ⁴ x10 ⁴	mm ⁶ x10 ⁹								
HP 8 x 29	29	3888	388,8	434,5	8,47	19,85	1294	126,2	193,4	4,89	38,72	17,68	117,9	2	3	-	2	3	-	✓
HP 8 x 36	36	4977	488,0	551,3	8,55	24,89	1673	161,7	248,6	4,96	45,62	34,20	155,1	1	2	-	1	2	-	✓
HP 10 x 42	42	8753	711,6	792,8	10,47	28,94	2995	234,0	358,0	6,13	47,13	37,02	414,1	3	3	-	3	3	-	✓
HP 10 x 57	57	12300	968,9	1096	10,64	39,70	4225	325,0	499,9	6,23	58,43	89,32	605,4	1	2	3	1	2	3	✓
HP 12 x 53	53	16270	1088	1207	12,77	36,91	5258	343,6	525,1	7,26	50,57	50,30	1089	3	4	-	3	4	-	✓
HP 12 x 63	63	19630	1296	1447	12,85	43,84	6387	414,7	635,1	7,33	56,87	82,53	1340	3	3	-	3	3	-	✓
HP 12 x 74	74	23660	1536	1727	12,97	51,63	7707	497,2	763,3	7,40	63,97	133,1	1646	1	3	3	1	3	3	✓
HP 12 x 84	84	27030	1733	1960	13,05	58,41	8823	565,6	870,2	7,46	69,77	188,2	1911	1	2	3	1	2	3	✓
HP 12 x 89	89	28680	1827	2072	13,10	61,53	9370	598,7	922,1	7,48	72,47	218,5	2044	1	1	3	1	1	3	✓
HP 14 x 73	73	30290	1751	1937	14,83	48,42	10810	584,5	891,2	8,86	55,97	88,99	2999	3	4	-	3	4	-	✓
HP 14 x 89	89	37480	2135	2381	14,93	58,93	13510	724,2	1107	8,96	64,37	158,0	3795	3	3	4	3	3	4	✓
HP 14 x 102	102	43880	2465	2765	15,04	67,82	15880	844,5	1293	9,05	71,27	237,1	4532	2	3	3	2	3	3	✓
HP 14 x 117	117	50840	2816	3180	15,15	77,53	18390	973,0	1493	9,11	78,77	349,1	5326	1	2	3	1	2	3	✓

◆ W_{pl} : para el diseño plástico la sección debe pertenecer a la clase 1 o 2 según la capacidad de rotación que se precise. Véase pág. 203.

◆ W_{pl} : for plastic design, the shape must belong to class 1 or 2 according to the required rotation capacity. See page 203.

◆ W_{pl} : per il calcolo plastico, la sezione trasversale deve appartenere alla classe 1 o 2, conformemente alla capacità di rotazione richiesta. Vedere pagina 203.

Perfiles U americanos estándar de alas inclinadas

Inclinación de las alas: aprox. 16 $\frac{2}{3}$ %
 Dimensiones: ASTM A 6/A 6M - 07
 Tolerancias: ASTM A 6/A 6M - 07
 Estado de la superficie: conforme a ASTM A 6/A 6M - 07

American standard channels

Flange slope: approx. 16 $\frac{2}{3}$ %
 Dimensions: ASTM A 6/A 6M - 07
 Tolerances: ASTM A 6/A 6M - 07
 Surface condition: according to ASTM A 6/A 6M - 07

Profili U standard ad ali inclinate

Inclinazione dell'ala: appross. 16 $\frac{2}{3}$ %
 Dimensioni: ASTM A 6/A 6M - 07
 Tolleranze: ASTM A 6/A 6M - 07
 Condizioni di superficie: conformi ad ASTM A 6/A 6M - 07

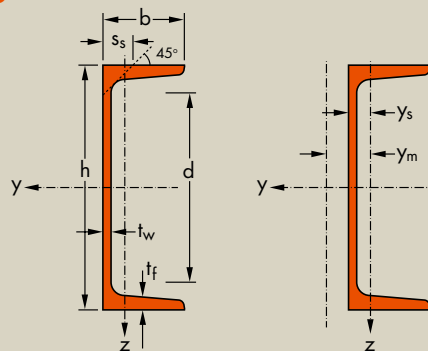

Denominación Designation Designazione (metric)	Dimensiones Dimensions Dimensioni						Superficie Surface Superficie		
	G kg/m	h mm	b mm	t _w mm	t _f mm	d mm	A mm ² x10 ²	A _L m ² /m	A _G m ² /t
C 75 x 6.1*	6,1	76	35	4,3	6,9	38	7,81	0,277	45,47
C 75 x 7.4*	7,4	76	37	6,6	6,9	38	9,48	0,281	37,95
C 75 x 8.9*	8,9	76	40	9,0	6,9	38	11,3	0,288	32,35
C 100 x 8*	8,0	102	40	4,7	7,5	66	10,3	0,347	43,36
C 100 x 10.8*	10,8	102	43	8,2	7,5	60	13,7	0,352	32,55
C 130 x 10.4*	10,4	127	44	4,8	8,1	83	12,7	0,424	40,77
C 130 x 13*	13,0	127	47	8,3	8,1	86	17,0	0,422	31,47
C 150 x 12.2*	12,2	152	48	5,1	8,7	107	15,5	0,478	39,19
C 150 x 15.6*	15,6	152	51	8,0	8,7	107	19,9	0,484	31,05
C 150 x 19.3*	19,3	152	54	11,1	8,7	105	24,7	0,490	25,39
C 180 x 14.6*	14,6	178	53	5,3	9,3	130	18,5	0,548	37,51
C 180 x 18.2*	18,2	178	55	8,0	9,3	130	23,2	0,550	30,24
C 180 x 22*	22,0	178	58	10,6	9,3	125	27,9	0,557	25,30
C 200 x 17.1*	17,1	203	57	5,6	9,9	156	21,8	0,564	33,22
C 200 x 20.5*	20,5	203	59	7,7	9,9	156	26,1	0,577	28,82
C 200 x 27.9*	27,9	203	64	12,4	9,9	156	35,5	0,584	21,41
C 230 x 19.9*	19,9	229	61	5,9	10,5	177	25,4	0,679	34,11
C 230 x 22*	22,0	229	63	7,2	10,5	177	28,5	0,684	30,68
C 230 x 30*	30,0	229	67	11,4	10,5	173	37,9	0,692	23,20
C 250 x 22.8*	22,8	254	65	6,1	11,1	203	29,0	0,692	30,85
C 250 x 30*	30,0	254	69	9,6	11,1	203	37,9	0,701	23,98
C 250 x 37*	37,0	254	73	13,4	11,1	203	47,4	0,713	19,52
C 250 x 45*	45,0	254	76	17,1	11,1	203	56,9	0,721	16,58
C 310 x 30.8*	30,8	305	74	7,2	12,7	248	39,3	0,825	26,60
C 310 x 37*	37,0	305	77	9,8	12,7	248	47,4	0,841	22,71
C 310 x 45*	45,0	305	80	13,0	12,7	248	56,9	0,824	18,27
C 380 x 50.4*	50,4	381	86	10,2	16,5	308	64,3	1,048	20,96
C 380 x 60*	60,0	381	89	13,2	16,5	308	76,1	1,037	17,55
C 380 x 74*	74,0	381	94	18,2	16,5	308	94,8	1,040	14,05

* Tonelaje mínimo y condiciones de suministro previo acuerdo.

* Minimum tonnage and delivery conditions upon agreement.

* Tonnellaggio minimo e condizioni di fornitura da concordare.



Páginas de notaciones 199-203 / Notations pages 199-203 / Pagine di annotazioni 199-203

Denominación Designation Designazione (imperial)	Propiedades de perfil / Section properties / Proprietà geometriche del profilo															Classification EN 1993-1-1: 2005				A572/A709/A992
	eje fuerte y-y strong axis y-y asse forte y-y						eje débil z-z weak axis z-z asse debole z-z									Pure bending y-y	Pure compression			
	G	I_y	$W_{el,y}$	W_{ply} ■	i_y	A_{vz}	I_z	$W_{el,z}$	$W_{pl,z}$	i_z	s_s	I_t	I_w	y_s	y_m	S235	S355	S235	S355	
lbs/ft	mm ⁴ x10 ⁴	mm ³ x10 ³	mm ³ x10 ³	mm x10	mm ² x10 ²	mm ⁴ x10 ⁴	mm ³ x10 ³	mm ³ x10 ³	mm x10	mm	mm ⁴ x10 ⁴	mm ⁶ x10 ⁹	mm x10	mm x10						
C 3 x 4.1	4,1	69,1	18,1	21,7	2,98	3,78	7,96	3,27	6,40	1,01	18,2	1,31	0,07	1,06	1,99	1	1	1	1	✓
C 3 x 5	5,0	76,6	20,1	24,9	2,85	5,33	9,63	3,65	7,36	1,01	20,4	2,20	0,09	1,06	1,83	1	1	1	1	✓
C 3 x 6	6,0	86,4	22,7	28,7	2,76	7,00	12,1	4,19	8,80	1,03	23,2	4,14	0,11	1,13	1,76	1	1	1	1	✓
C 4 x 5.4	5,4	160	31,6	37,8	3,97	5,14	13,8	4,89	9,40	1,16	18,4	1,67	0,22	1,15	2,21	1	1	1	1	✓
C 4 x 7.25	7,25	191	37,6	47,0	3,72	8,59	17,4	5,48	11,3	1,12	23,2	4,25	0,30	1,13	1,90	1	1	1	1	✓
C 5 x 6.7	6,7	332	52,3	61,8	5,01	6,81	24,3	7,19	14,1	1,36	21,2	2,72	0,62	1,29	2,53	1	1	1	1	✓
C 5 x 9	9,0	371	58,5	73,1	4,66	10,7	27,4	7,65	15,3	1,27	23,5	4,90	0,73	1,21	2,11	1	1	1	1	✓
C 6 x 8.2	8,2	548	72,0	85,6	5,94	8,50	29,2	8,30	16,1	1,37	22,1	3,37	1,09	1,26	2,49	1	1	1	1	✓
C 6 x 10.5	10,5	630	82,7	103	5,63	12,6	36,0	9,36	18,7	1,35	24,8	5,96	1,40	1,24	2,23	1	1	1	1	✓
C 6 x 13	13,0	721	94,6	121	5,41	17,1	42,4	10,3	22,1	1,31	28,6	12,0	1,72	1,28	2,02	1	1	1	1	✓
C 7 x 9.8	9,8	896	101	120	6,94	10,2	42,7	10,9	21,1	1,52	23,3	4,39	2,18	1,36	2,73	1	1	1	1	✓
C 7 x 12.25	12,25	1007	113	140	6,59	14,7	49,2	11,8	23,4	1,46	25,9	7,25	2,62	1,31	2,41	1	1	1	1	✓
C 7 x 14.75	14,75	1143	129	163	6,39	19,3	56,8	12,7	27,0	1,42	30,0	13,9	3,19	1,33	2,21	1	1	1	1	✓
C 8 x 11.5	11,5	1340	132	156	7,86	13,2	53,8	12,6	27,6	1,57	29,3	5,86	3,79	1,44	3,19	1	1	1	2	✓
C 8 x 13.75	13,75	1490	147	177	7,57	16,7	62,0	13,7	30,0	1,54	27,5	7,60	4,50	1,39	2,90	1	1	1	1	✓
C 8 x 18.75	18,75	1820	179	226	7,15	26,0	81,7	16,4	35,9	1,51	30,6	17,9	6,00	1,43	2,51	1	1	1	1	✓
C 9 x 13.4	13,4	1991	174	208	8,86	14,4	76,1	16,7	31,9	1,73	25,7	7,08	6,47	1,50	3,05	1	1	1	2	✓
C 9 x 15	15,0	2132	187	226	8,66	17,2	85,3	17,8	34,3	1,73	26,9	8,80	7,39	1,49	2,93	1	1	1	1	✓
C 9 x 20	20,0	2544	223	282	8,19	26,4	103	19,8	41,0	1,65	32,1	19,9	9,52	1,47	2,52	1	1	1	1	✓
C 10 x 15.3	15,3	2770	218	257	9,81	17,6	91,2	18,5	40,3	1,78	32,0	9,15	10,4	1,58	3,55	1	1	2	3	✓
C 10 x 20	20,0	3260	257	315	9,29	26,1	114	21,2	46,5	1,74	33,6	15,7	13,1	1,53	3,13	1	1	1	1	✓
C 10 x 25	25,0	3790	298	377	8,93	35,2	138	24,0	52,6	1,70	34,4	28,6	16,2	1,56	2,80	1	1	1	1	✓
C 10 x 30	30,0	4270	336	434	8,68	44,0	158	26,5	57,4	1,67	35,2	48,8	19,5	1,63	2,53	1	1	1	1	✓
C 12 x 20.7	20,7	5340	350	415	11,7	24,5	157	27,7	60,2	2,00	35,1	16,0	24,8	1,74	3,91	1	1	2	4	✓
C 12 x 25	25,0	5970	391	477	11,2	31,3	183	30,5	66,0	1,97	33,5	21,9	29,5	1,70	3,58	1	1	1	1	✓
C 12 x 30	30,0	6720	441	551	10,9	42,5	209	33,2	72,1	1,92	41,8	39,2	34,4	1,70	3,24	1	1	1	1	✓
C 15 x 33.9	33,9	13100	688	825	14,3	38,7	334	50,5	107	2,28	32,1	38,3	83,4	1,99	4,24	1	1	1	2	✓
C 15 x 40	40,0	14400	756	934	13,8	50,9	379	54,7	115	2,24	38,3	57,3	96,4	1,97	3,90	1	1	1	1	✓
C 15 x 50	50,0	16700	877	1120	13,3	69,7	454	61,5	130	2,19	42,7	108	118	2,02	3,48	1	1	1	1	✓

- W_{ply} se calcula según la hipótesis de un diagrama de tensiones birrectangular y sólo será aplicable cuando dos o más perfiles de sección en U estén combinados de tal manera que constituyan una sección doblemente simétrica, de tal modo que el momento de flexión que actúa en el plano del centro de gravedad no produzca torsión alguna.
- W_{ply} is determined assuming a bi-rectangular stress block distribution. Thus, the given value applies only if two or more channels are combined in such a way to form a double symmetric cross-section so that the bending moment acting in the plane of the centre of gravity will not lead to torsion.
- W_{ply} viene determinado presupponendo un diagramma delle sollecitazioni bi-rettangolare. Pertanto il valore dato vale unicamente se due o più sezioni ad U vengono combinate in modo tale da formare una sezione doppiamente simmetrica cosicché il momento flettente che agisce nel piano baricentrico non produce torsione.

Perfiles U americanos de alas inclinadas

Dimensiones: ASTM A 6/A 6M - 07

Tolerancias: ASTM A 6/A 6M - 07

Estado de la superficie: conforme a ASTM A 6/A 6M - 07

American Channels

Dimensions: ASTM A 6/A 6M - 07

Tolerances: ASTM A 6/A 6M - 07

Surface condition: according to ASTM A 6/A 6M - 07

Profili U ad ali inclinate

Dimensioni: ASTM A 6/A 6M - 07

Tolleranze: ASTM A 6/A 6M - 07

Condizioni di superficie: conformi ad ASTM A 6/A 6M - 07.

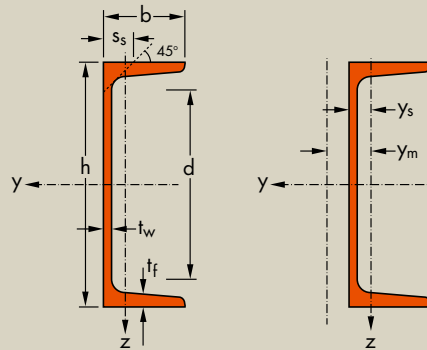

Denominación Designation Designazione (metric)	Dimensiones Dimensions Dimensioni						Superficie Surface Superficie		
	G kg/m	h mm	b mm	t _w mm	t _f mm	d mm	A mm ² x10 ²	A _L m ² /m	A _C m ² /t
MC 150 x 17.9*	17,9	152	63	7,9	9,5	101	22,80	0,530	29,63
MC 150 x 22.5*	22,5	152	74	8,0	12,1	89	28,60	0,570	25,42
MC 150 x 22.8*	22,8	152	88	8,6	9,8	91,7	29,00	0,620	27,36
MC 150 x 24.3*	24,3	152	76	9,5	12,1	88,2	30,90	0,570	23,68
MC 150 x 26.8*	26,8	152	88	9,6	12,1	85,4	34,10	0,620	23,28
MC 180 x 28.4*	28,4	178	87	8,9	12,7	110	36,20	0,670	23,63
MC 180 x 33.8*	33,8	178	91	12,8	12,7	109	43,00	0,680	20,12
MC 200 x 12.6*	12,6	203	47	4,5	7,9	162	16,10	0,580	45,69
MC 200 x 27.8*	27,8	203	75	9,0	12,7	140	35,50	0,680	24,29
MC 200 x 29.8*	29,8	203	76	10,2	12,7	136	37,90	0,680	22,71
MC 200 x 31.8*	31,8	203	87	9,5	13,3	132	40,50	0,720	22,66
MC 200 x 33.9*	33,9	203	88	10,8	13,3	130	43,20	0,720	21,30
MC 230 x 35.6*	35,6	229	87	10,2	14,0	158	45,30	0,770	21,65
MC 230 x 37.8*	37,8	229	88	11,4	14,0	155	48,20	0,770	20,43
MC 250 x 12.5*	12,5	254	38	4,3	7,1	215	15,90	0,640	51,40
MC 250 x 33*	33,0	254	84	7,4	14,6	179	41,60	0,810	24,70
MC 250 x 37*	37,0	254	86	9,7	14,6	186	47,40	0,820	22,09
MC 250 x 42.4*	42,4	254	100	10,8	14,6	178	54,00	0,870	20,51
MC 250 x 50*	50,0	254	104	14,6	14,6	178	63,70	0,880	17,63
MC 250 x 61.2*	61,2	254	110	20,2	14,6	170	78,10	0,890	14,55
MC 310 x 15.8*	15,8	305	38	4,8	7,8	262	20,00	0,750	47,40
MC 310 x 46*	46,0	305	93	9,4	17,8	225	58,90	0,960	20,95
MC 310 x 52*	52,0	305	96	11,8	17,8	218	66,20	0,960	18,52
MC 310 x 60*	60,0	305	98	15,0	17,8	214	76,10	0,960	16,17
MC 310 x 67*	67,0	305	102	18,0	17,8	214	85,02	0,970	14,53
MC 310 x 74*	74,0	305	105	21,2	17,8	222	94,80	0,980	13,21

* Tonelaje mínimo y condiciones de suministro previo acuerdo.

* Minimum tonnage and delivery conditions upon agreement.

* Tonnellaggio minimo e condizioni di fornitura da concordare.

Páginas de notaciones 199-203 / Notations pages 199-203 / Pagine di annotazioni 199-203

Denominación Designation Designazione (imperial)	Propiedades de perfil / Section properties / Proprietà geometriche del profilo														Classification EN 1993-1-1: 2005				A572/A709/A992	
	G	eje fuerte y-y strong axis y-y asse forte y-y					eje débil z-z weak axis z-z asse debole z-z					Pure bending y-y		Pure compression						
		I_y lbs/ft mm ⁴ x10 ⁴	$W_{el,y}$ mm ³ x10 ³	W_{ply} mm ³ x10 ³	i_y mm x10	A_z mm ² x10 ²	I_z mm ⁴ x10 ⁴	$W_{el,z}$ mm ³ x10 ³	$W_{pl,z}$ mm ³ x10 ³	i_z mm x10	s_s mm	I_t mm ⁴ x10 ⁴	I_w mm ⁶ x10 ⁹	y_s mm x10	y_m mm x10	S235	S355	S235		S355
MC 6 x 12	12,0	773	102	123	5,83	12,7	69,8	15,1	29,6	1,75	27,1	7,89	2,60	1,63	3,11	1	1	1	1	✓
MC 6 x 15.1	15,1	1033	136	162	6,01	13,4	134	25,8	49,7	2,16	31,8	14,0	4,66	2,18	4,21	1	1	1	1	✓
MC 6 x 15.3	15,3	1050	138	164	6,01	14,2	178	27,9	55,2	2,48	30,8	12,9	6,58	2,31	4,54	1	1	1	1	✓
MC 6 x 16.3	16,3	1081	142	171	5,91	15,5	147	27,2	53,3	2,17	33,5	17,1	5,18	2,17	4,11	1	1	1	1	✓
MC 6 x 18	18,0	1223	161	192	5,99	15,8	219	35,4	68,7	2,54	34,6	19,7	7,70	2,53	4,88	1	1	1	1	✓
MC 7 x 19.1	19,1	1797	202	239	7,05	17,3	230	37,4	72,2	2,52	34,5	20,2	11,2	2,46	4,81	1	1	1	1	✓
MC 7 x 22.7	22,7	1973	222	271	6,77	23,7	271	40,8	80,9	2,51	38,7	32,9	13,6	2,42	4,47	1	1	1	1	✓
MC 8 x 8.5	8,5	971	95,7	115	7,77	9,74	27,1	7,53	14,5	1,30	20,0	2,54	1,89	1,07	2,19	1	1	2	4	✓
MC 8 x 18.7	18,7	2171	214	258	7,83	19,4	160	29,3	56,8	2,13	33,1	17,9	10,4	1,99	3,84	1	1	1	1	✓
MC 8 x 20	20,0	2261	223	271	7,72	21,9	167	29,8	58,7	2,10	35,2	22,3	11,2	1,97	3,69	1	1	1	1	✓
MC 8 x 21.4	21,4	2555	252	300	7,94	20,8	251	40,0	78,0	2,49	36,1	24,5	16,2	2,36	4,61	1	1	1	1	✓
MC 8 x 22.8	22,8	2645	261	314	7,83	23,4	262	40,7	80,3	2,46	38,1	29,8	17,3	2,33	4,44	1	1	1	1	✓
MC 9 x 23.9	23,9	3547	310	373	8,84	24,7	275	43,2	83,8	2,46	37,2	28,8	22,9	2,29	4,43	1	1	1	1	✓
MC 9 x 25.4	25,4	3670	321	389	8,73	27,5	286	43,9	86,3	2,44	39,1	34,5	24,2	2,26	4,28	1	1	1	1	✓
MC 10 x 8.4	8,4	1354	107	132	9,20	11,5	14,1	4,59	9,14	0,94	18,7	1,95	1,70	0,71	1,40	1	1	4	4	✓
MC 10 x 22	22,0	4310	339	397	10,1	21,0	255	42,2	81,3	2,46	35,9	24,4	25,8	2,30	4,65	1	1	1	1	✓
MC 10 x 25	25,0	4543	358	430	9,81	25,8	285	45,3	86,5	2,46	36,1	28,2	28,9	2,25	4,42	1	1	1	1	✓
MC 10 x 28.5	28,5	5257	414	496	9,87	29,0	433	59,0	114	2,83	39,7	38,2	44,5	2,58	5,09	1	1	1	1	✓
MC 10 x 33.6	33,6	5750	453	558	9,52	37,9	498	63,8	126	2,80	43,3	58,0	52,7	2,55	4,74	1	1	1	1	✓
MC 10 x 41.1	41,1	6550	516	654	9,17	51,7	582	69,2	146	2,73	51,0	124	65,2	2,59	4,32	1	1	1	1	✓
MC 12 x 10.6	10,6	2338	153	196	10,8	15,5	15,9	5,08	10,8	0,89	20,9	3,20	3,22	0,69	1,30	1	1	4	4	✓
MC 12 x 31	31,0	8292	544	661	12,0	31,4	436	65,0	129	2,74	41,1	53,4	70,6	2,61	5,32	1	1	1	1	✓
MC 12 x 35	35,0	8998	590	726	11,7	39,1	487	68,7	138	2,71	45,6	70,1	82,1	2,55	5,00	1	1	1	1	✓
MC 12 x 40	40,0	9732	638	798	11,3	48,7	526	71,5	146	2,63	49,9	97,7	91,5	2,48	4,57	1	1	1	1	✓
MC 12 x 45	45,0	10510	689	873	11,1	57,4	597	77,5	161	2,65	52,9	131	105	2,53	4,41	1	1	1	1	✓
MC 12 x 50	50,0	11140	731	939	10,9	65,9	664	83,5	175	2,65	54,0	164	116	2,59	4,24	1	1	1	1	✓

■ W_{ply} : se calcula según la hipótesis de un diagrama de tensiones birrectangular y sólo será aplicable cuando dos o más perfiles de sección en U estén combinados de tal manera que constituyan una sección doblemente simétrica, de tal modo que el momento de flexión que actúa en el plano del centro de gravedad no produzca torsión alguna.

■ W_{ply} : is determined assuming a bi-rectangular stress block distribution. Thus, the given value applies only if two or more channels are combined in such a way to form a double symmetric cross-section so that the bending moment acting in the plane of the centre of gravity will not lead to torsion.

■ W_{ply} viene determinado presupponendo un diagramma delle sollecitazioni bi-rettangolare. Pertanto il valore dato vale unicamente se due o più sezioni ad U vengono combinate in modo tale da formare una sezione doppiamente simmetrica cosicché il momento flettente che agisce nel piano baricentrico non produce torsione.

Perfiles U americanos de alas inclinadas (continúa)

Dimensiones: ASTM A 6/A 6M - 07
Tolerancias: ASTM A 6/A 6M - 07
Estado de la superficie: conforme a ASTM A 6/A 6M - 07

American Channels (continued)

Dimensions: ASTM A 6/A 6M - 07
Tolerances: ASTM A 6/A 6M - 07
Surface condition: according to ASTM A 6/A 6M - 07

Profili U ad ali inclinate (continua)

Dimensioni: ASTM A 6/A 6M - 07
Tolleranze: ASTM A 6/A 6M - 07
Condizioni di superficie: conformi ad ASTM A 6/A 6M - 07.

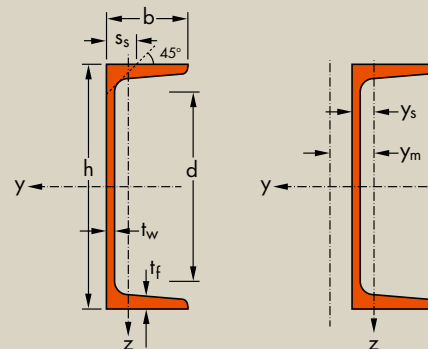

Denominación Designation Designazione (metric)	Dimensiones Dimensions Dimensioni						Superficie Surface Superficie		
	G kg/m	h mm	b mm	t _w mm	t _f mm	d mm	A mm ² x10 ²	A _L m ² /m	A _G m ² /t
MC 330 x 47.3*	47,3	330	102	9,5	15,5	242	60,30	1,040	21,95
MC 330 x 52*	52,0	330	103	11,4	15,5	242	66,40	1,040	19,96
MC 330 x 60*	60,0	330	106	14,2	15,5	236	76,10	1,050	17,48
MC 330 x 74*	74,0	330	112	20,0	15,5	247	94,80	1,060	14,29
MC 460 x 63.5*	63,5	457	100	11,4	15,9	366	81,30	1,280	20,18
MC 460 x 68.2*	68,2	457	102	12,7	15,9	370	87,10	1,290	18,91
MC 460 x 77.2*	77,2	457	104	15,2	15,9	366	98,70	1,290	16,71
MC 460 x 86*	86,0	457	107	17,8	15,9	375	110,0	1,300	15,09

* Tonelaje mínimo y condiciones de suministro previo acuerdo.

* Minimum tonnage and delivery conditions upon agreement.

* Tonnellaggio minimo e condizioni di fornitura da concordare.

Páginas de notaciones 199-203 / Notations pages 199-203 / Pagine di annotazioni 199-203

Denominación Designation Designazione (imperial)	Propiedades de perfil / Section properties / Proprietà geometriche del profilo															Classification EN 1993-1-1: 2005				A572/A709/A992
	eje fuerte y-y strong axis y-y asse forte y-y					eje débil z-z weak axis z-z asse debole z-z										Pure bending y-y		Pure compression		
	G	I_y	$W_{el,y}$	$W_{pl,y}$	i_y	A_v	I_z	$W_{el,z}$	$W_{pl,z}$	i_z	s_s	I_t	I_w	y_s	y_m	S235	S355	S235	S355	
lbs/ft	mm ⁴ x10 ⁴	mm ³ x10 ³	mm ³ x10 ³	mm x10	mm ² x10 ²	mm ⁴ x10 ⁴	mm ³ x10 ³	mm ³ x10 ³	mm x10	mm	mm ⁴ x10 ⁴	mm ⁶ x10 ⁹	mm x10	mm x10						
MC 13 x 31.8	31,8	9986	605	739	12,9	35,0	500	65,1	136	2,88	42,9	53,4	107	2,58	5,34	1	1	1	1	✓
MC 13 x 35	35,0	10500	636	786	12,6	41,1	526	67,0	140	2,82	44,7	64,5	115	2,50	5,03	1	1	1	1	✓
MC 13 x 40	40,0	11470	695	870	12,3	50,4	576	70,2	150	2,75	49,1	95,5	131	2,45	4,67	1	1	1	1	✓
MC 13 x 50	50,0	12990	787	1016	11,7	67,8	708	81,0	175	2,74	51,7	151	158	2,52	4,30	1	1	1	1	✓
MC 18 x 42.7	42,7	23040	1008	1263	16,9	55,7	535	67,4	141	2,57	45,6	73,3	237	2,11	4,23	1	1	1	3	✓
MC 18 x 45.8	45,8	24010	1051	1330	16,6	61,2	576	70,9	149	2,58	45,8	81,8	254	2,12	4,15	1	1	1	2	✓
MC 18 x 51.9	51,9	26090	1142	1463	16,3	72,6	611	73,2	159	2,49	49,4	116	276	2,10	3,83	1	1	1	1	✓
MC 18 x 58	58,0	27850	1219	1587	16,0	83,2	682	79,3	173	2,50	49,3	141	303	2,14	3,68	1	1	1	1	✓

■ $W_{pl,y}$: se calcula según la hipótesis de un diagrama de tensiones birrectangular y sólo será aplicable cuando dos o más perfiles de sección en U estén combinados de tal manera que constituyan una sección doblemente simétrica, de tal modo que el momento de flexión que actúa en el plano del centro de gravedad no produzca torsión alguna.

■ $W_{pl,y}$: is determined assuming a bi-rectangular stress block distribution. Thus, the given value applies only if two or more channels are combined in such a way to form a double symmetric cross-section so that the bending moment acting in the plane of the centre of gravity will not lead to torsion.

■ $W_{pl,y}$ viene determinado presupponendo un diagramma delle sollecitazioni bi-rettangolare. Pertanto il valore dato vale unicamente se due o più sezioni ad U vengono combinate in modo tale da formare una sezione doppiamente simmetrica cosicché il momento flettente che agisce nel piano baricentrico non produce torsione.

Perfiles americanos angulares de lados iguales

Dimensiones: ASTM A 6/A 6M - 07
Tolerancias: ASTM A 6/A 6M - 07
Estado de la superficie: conforme a ASTM A 6/A 6M - 07

American equal leg angles

Dimensions: ASTM A 6/A 6M - 07
Tolerances: ASTM A 6/A 6M - 07
Surface condition: according to ASTM A 6/A 6M - 07

Angolari a lati uguali

Dimensioni: ASTM A 6/A 6M - 07
Tolleranze: ASTM A 6/A 6M - 07
Condizioni di superficie: conformi ad ASTM A 6/A 6M - 07

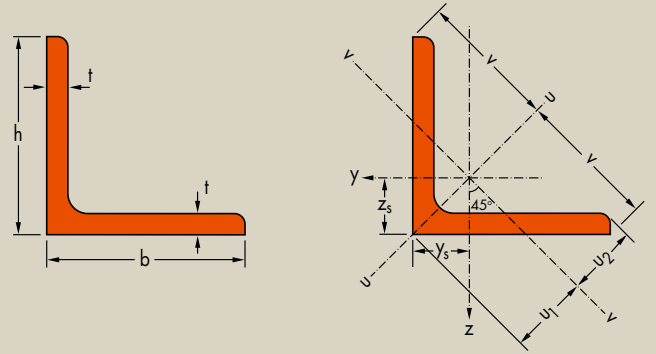

Denominación Designation Designazione (metric)	Dimensiones Dimensions Dimensioni			A	Posición de ejes Position of axes Posizione degli assi				Superficie Surface Superficie	
	h = b	t			$z_s = y_s$	v	u_1	u_2	A_L	A_G
G	mm	mm		mm ² x10 ²	mm x10	mm x10	mm x10	mm x10	m ² /m	m ² /t
L 19 x 19 x 3.2 ^{∇*}	0,9	19,1	3,18	1,11	0,57	1,35	0,80	0,65	0,071	78,89
L 25 x 25 x 3.2 ^{∇*}	1,2	25,4	3,18	1,51	0,74	1,80	1,04	0,90	0,098	81,67
L 25 x 25 x 4.8 ^{∇*}	1,8	25,4	4,76	2,19	0,78	1,80	1,10	0,87	0,094	52,22
L 25 x 25 x 6.4 ^{∇*}	2,2	25,4	6,35	2,83	0,85	1,80	1,21	0,93	0,097	44,09
L 32 x 32 x 3.2 ^{∇*}	1,5	31,8	3,18	1,92	0,89	2,25	1,26	1,11	0,123	82,00
L 32 x 32 x 4.8 ^{∇*}	2,2	31,8	4,76	2,80	0,95	2,25	1,35	1,13	0,123	55,91
L 32 x 32 x 6.4 ^{∇*}	2,8	31,8	6,35	3,63	1,02	2,25	1,45	1,22	0,126	45,00
L 38 x 38 x 3.2 ^{∇*}	1,8	38,1	3,18	2,32	1,04	2,69	1,48	1,34	0,148	82,22
L 38 x 38 x 4.0 ^{∇*}	2,2	38,1	3,97	2,86	1,09	2,69	1,54	1,35	0,150	68,18
L 38 x 38 x 4.8 ^{∇*}	2,7	38,1	4,76	3,40	1,11	2,69	1,57	1,36	0,148	54,81
L 38 x 38 x 6.4 ^{∇*}	3,4	38,1	6,35	4,44	1,16	2,69	1,64	1,30	0,148	43,53
L 44 x 44 x 3.2 ^{∇*}	2,1	44,5	3,18	2,72	1,22	3,14	1,72	1,59	0,175	83,33
L 44 x 44 x 4.8 ^{∇*}	3,1	44,5	4,76	4,01	1,28	3,14	1,82	1,62	0,176	56,77
L 44 x 44 x 6.4 ^{∇*}	4,1	44,5	6,35	5,25	1,33	3,14	1,88	1,59	0,173	42,20
L 51 x 51 x 3.2 ^{∇*}	2,4	50,8	3,18	3,12	1,32	3,59	1,87	1,74	0,196	81,67
L 51 x 51 x 4.8 ^{∇*}	3,6	50,8	4,76	4,61	1,43	3,59	2,02	1,81	0,199	55,28
L 51 x 51 x 6.4 ^{∇*}	4,7	50,8	6,35	6,05	1,48	3,59	2,10	1,78	0,198	42,13
L 51 x 51 x 7.9 ^{∇*}	5,8	50,8	7,94	7,42	1,54	3,59	2,17	1,78	0,197	33,97
L 51 x 51 x 9.5 ^{∇*}	7,0	50,8	9,53	8,77	1,59	3,59	2,25	1,83	0,195	27,86
L 64 x 64 x 4.8 ^{∇*}	4,6	63,5	4,76	5,81	1,75	4,49	2,47	2,25	0,250	54,35
L 64 x 64 x 6.4 ^{∇*}	6,1	63,5	6,35	7,68	1,79	4,49	2,53	2,24	0,247	40,49
L 64 x 64 x 7.9 ^{∇*}	7,4	63,5	7,94	9,42	1,87	4,49	2,64	2,31	0,250	33,78
L 64 x 64 x 9.5 ^{∇*}	8,7	63,5	9,53	11,2	1,92	4,49	2,71	2,25	0,248	28,51
L 64 x 64 x 12.7 ^{∇*}	11,4	63,5	12,7	14,5	2,04	4,49	2,89	2,39	0,250	21,93

∇ Otras dimensiones previa solicitud.
* Tonelaje mínimo y condiciones de suministro previo acuerdo.

∇ Other dimensions on request.
* Minimum tonnage and delivery conditions upon agreement.

∇ Dimensioni di dettaglio disponibili su richiesta.
* Tonnellaggio minimo e condizioni di fornitura da concordare.



Páginas de notaciones 199-203 / Notations pages 199-203 / Pagine di annotazioni 199-203

Denominación Designation Designazione (imperial)	Propiedades de perfil / Section properties / Proprietà geometriche del profilo									Classification EN 1993-1-1: 2005		A572/A709/A992
	eje y-y / eje z-z axis y-y / axis z-z asse y-y / asse z-z			eje u-u axis u-u asse u-u		eje v-v axis v-v asse v-v		pure compression				
	$I_y = I_z$	$W_{el,y} = W_{el,z}$	$i_y = i_z$	I_u	i_u	I_v	i_v	I_{yz}	S235	S355		
G lbs/ft	mm ⁴ x10 ⁴	mm ³ x10 ³	mm x10	mm ⁴ x10 ⁴	mm x10	mm ⁴ x10 ⁴	mm x10	mm ⁴ x10 ⁴				
L 3/4 x 3/4 x 1/8	0,59	0,33	0,25	0,54	0,52	0,67	0,14	0,35	-0,19	1	1	✓
L 1 x 1 x 1/8	0,80	0,88	0,49	0,76	1,40	0,96	0,36	0,49	-0,52	1	1	✓
L 1 x 1 x 3/16	1,16	1,15	0,66	0,71	1,82	0,89	0,49	0,46	-0,66	1	1	✓
L 1 x 1 x 1/4	1,49	1,50	0,89	0,73	2,32	0,90	0,68	0,49	-0,82	1	1	✓
L 1 1/4 x 1 1/4 x 1/8	1,01	1,78	0,78	0,96	2,82	1,21	0,73	0,61	-1,05	1	3	✓
L 1 1/4 x 1 1/4 x 3/16	1,48	2,51	1,13	0,94	3,97	1,19	1,05	0,61	-1,46	1	1	✓
L 1 1/4 x 1 1/4 x 1/4	1,92	3,19	1,48	0,94	5,00	1,17	1,39	0,62	-1,81	1	1	✓
L 1 1/2 x 1 1/2 x 1/8	1,23	3,15	1,14	1,16	5,01	1,46	1,30	0,74	-1,86	3	3	✓
L 1 1/2 x 1 1/2 x 5/32	1,52	3,86	1,42	1,16	6,15	1,47	1,58	0,74	-2,29	1	3	✓
L 1 1/2 x 1 1/2 x 3/16	1,80	4,49	1,67	1,15	7,13	1,44	1,86	0,74	-2,63	1	1	✓
L 1 1/2 x 1 1/2 x 1/4	2,34	5,40	2,04	1,12	8,55	1,41	2,25	0,72	-3,15	1	1	✓
L 1 3/4 x 1 3/4 x 1/8	1,44	5,19	1,61	1,38	8,27	1,74	2,11	0,88	-3,08	3	4	✓
L 1 3/4 x 1 3/4 x 3/16	2,12	7,44	2,35	1,36	11,83	1,72	3,05	0,87	-4,39	1	3	✓
L 1 3/4 x 1 3/4 x 1/4	2,77	9,29	2,98	1,33	14,71	1,67	3,88	0,86	-5,42	1	1	✓
L 2 x 2 x 1/8	1,65	7,20	1,92	1,53	11,44	1,92	2,96	0,98	-4,24	3	4	✓
L 2 x 2 x 3/16	2,44	11,19	3,06	1,55	17,79	1,96	4,59	0,99	-6,60	2	3	✓
L 2 x 2 x 1/4	3,19	14,04	3,90	1,53	22,3	1,93	5,78	0,98	-8,26	1	1	✓
L 2 x 2 x 5/16	3,92	16,68	4,71	1,50	26,39	1,89	6,97	0,97	-9,71	1	1	✓
L 2 x 2 x 3/8	4,70	19,46	5,58	1,48	30,61	1,86	8,31	0,97	-11,15	1	1	✓
L 2 1/2 x 2 1/2 x 3/16	3,07	22,52	4,89	1,96	35,86	2,48	9,18	1,25	-13,34	3	4	✓
L 2 1/2 x 2 1/2 x 1/4	4,10	28,67	6,29	1,93	45,55	2,43	11,79	1,24	-16,88	1	3	✓
L 2 1/2 x 2 1/2 x 5/16	5,00	35,09	7,83	1,92	55,67	2,42	14,51	1,24	-20,58	1	1	✓
L 2 1/2 x 2 1/2 x 3/8	5,90	39,93	9,00	1,89	63,21	2,38	16,65	1,22	-23,28	1	1	✓
L 2 1/2 x 2 1/2 x 1/2	7,70	50,86	11,80	1,87	79,66	2,34	22,06	1,23	-28,80	1	1	✓

Perfiles americanos angulares de lados iguales (continúa)

Dimensiones: ASTM A 6/A 6M - 07

Tolerancias: ASTM A 6/A 6M - 07

Estado de la superficie: conforme a ASTM A 6/A 6M - 07

American equal leg angles (continued)

Dimensions: ASTM A 6/A 6M - 07

Tolerances: ASTM A 6/A 6M - 07

Surface condition: according to ASTM A 6/A 6M - 07

Angolari a lati uguali (continua)

Dimensioni: ASTM A 6/A 6M - 07

Tolleranze: ASTM A 6/A 6M - 07

Condizioni di superficie: conformi ad ASTM A 6/A 6M - 07

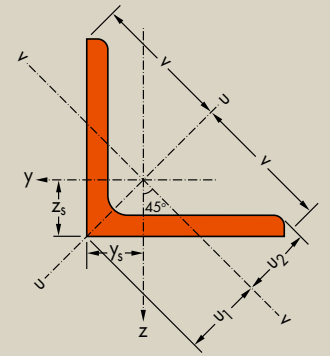
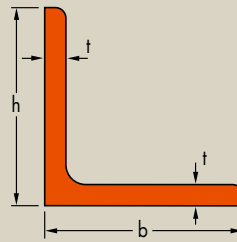

Denominación Designation Designazione (metric)	Dimensiones Dimensions Dimensioni			A	Posición de ejes Position of axes Posizione degli assi				Superficie Surface Superficie	
	G	h = b	t		z _s = y _s	v	u ₁	u ₂	A _L	A _G
kg/m	mm	mm	mm ² x10 ²	mm x10	mm x10	mm x10	mm x10	m ² /m	m ² /t	
L 76 x 76 x 4.8 ^{v/*}	5,5	76,2	4,76	7,03	2,06	5,39	2,92	2,70	0,301	54,73
L 76 x 76 x 6.4 ^{v/*}	7,3	76,2	6,35	9,29	2,13	5,39	3,01	2,72	0,301	41,23
L 76 x 76 x 7.9 ^{v/*}	9,1	76,2	7,94	11,5	2,17	5,39	3,07	2,71	0,298	32,75
L 76 x 76 x 9.5 ^{v/*}	10,7	76,2	9,53	13,6	2,25	5,39	3,18	2,78	0,301	28,13
L 76 x 76 x 11.1 ^{v/*}	12,4	76,2	11,1	15,7	2,29	5,39	3,24	2,77	0,298	24,03
L 76 x 76 x 12.7 ^{v/*}	14,0	76,2	12,7	17,7	2,35	5,39	3,33	2,79	0,298	21,29
L 89 x 89 x 6.4 ^{v/*}	8,6	88,9	6,35	10,9	2,42	6,29	3,43	3,14	0,349	40,58
L 89 x 89 x 7.9 ^{v/*}	10,7	88,9	7,94	13,5	2,48	6,29	3,51	3,15	0,348	32,52
L 89 x 89 x 9.5 ^{v/*}	12,6	88,9	9,53	16,0	2,56	6,29	3,63	3,23	0,351	27,86
L 89 x 89 x 11.1 ^{v/*}	14,6	88,9	11,1	18,5	2,62	6,29	3,71	3,26	0,351	24,04
L 89 x 89 x 12.7 ^{v/*}	16,5	88,9	12,7	21,0	2,68	6,29	3,79	3,29	0,351	21,27
L 102 x 102 x 6.4 ^{v/*}	9,8	102	6,35	12,5	2,76	7,18	3,90	3,63	0,402	41,02
L 102 x 102 x 7.9 ^{v/*}	12,2	102	7,94	15,5	2,82	7,18	3,99	3,65	0,402	32,95
L 102 x 102 x 9.5 ^{v/*}	14,6	102	9,53	18,5	2,87	7,18	4,05	3,64	0,399	27,33
L 102 x 102 x 11.1 ^{v/*}	16,8	102	11,1	21,4	2,94	7,18	4,16	3,71	0,402	23,93
L 102 x 102 x 12.7 ^{v/*}	19,0	102	12,7	24,2	3,00	7,18	4,24	3,74	0,402	21,16
L 102 x 102 x 15.9 ^{v/*}	23,4	102	15,9	29,7	3,11	7,18	4,40	3,80	0,402	17,18
L 102 x 102 x 19.0 ^{v/*}	27,5	102	19,1	35,1	3,23	7,18	4,57	3,90	0,404	14,69
L 127 x 127 x 7.9 ^{v/*}	15,3	127	7,94	19,6	3,46	8,98	4,90	4,56	0,505	33,01
L 127 x 127 x 9.5 ^{v/*}	18,3	127	9,53	23,3	3,52	8,98	4,98	4,59	0,505	27,60
L 127 x 127 x 11.1 ^{v/*}	21,3	127	11,1	27,0	3,56	8,98	5,03	4,55	0,500	23,47
L 127 x 127 x 12.7 ^{v/*}	24,1	127	12,7	30,7	3,63	8,98	5,13	4,58	0,501	20,79
L 127 x 127 x 15.9 ^{v/*}	29,8	127	15,9	37,8	3,75	8,98	5,30	4,68	0,502	16,85
L 127 x 127 x 19.0 ^{v/*}	35,1	127	19,1	44,8	3,87	8,98	5,47	4,77	0,505	14,35
L 127 x 127 x 22.2 ^{v/*}	40,5	127	22,2	51,5	3,98	8,98	5,62	4,81	0,503	12,42

^v Otras dimensiones previa solicitud.
* Tonelaje mínimo y condiciones de suministro previo acuerdo.

^v Other dimensions on request.
* Minimum tonnage and delivery conditions upon agreement.

^v Dimensioni di dettaglio disponibili su richiesta.
* Tonnellaggio minimo e condizioni di fornitura da concordare.



Páginas de notaciones 199-203 / Notations pages 199-203 / Pagine di annotazioni 199-203

Denominación Designation Designazione (imperial)	Propiedades de perfil / Section properties / Proprietà geometriche del profilo									Classification EN 1993-1-1: 2005		A572/A709/A992
	eje y-y / eje z-z axis y-y / axis z-z asse y-y / asse z-z			eje u-u axis u-u asse u-u		eje v-v axis v-v asse v-v		pure compression				
	G lbs/ft	$I_y = I_z$ mm ⁴ x10 ⁴	$W_{el,y} = W_{el,z}$ mm ³ x10 ³	$i_y = i_z$ mm x10	I_u mm ⁴ x10 ⁴	i_u mm x10	I_v mm ⁴ x10 ⁴	i_v mm x10	I_{yz} mm ⁴ x10 ⁴	S235	S355	
L 3 x 3 x 3/16	3,71	39,70	7,14	2,37	63,26	2,99	16,14	1,51	-23,56	4	4	✓
L 3 x 3 x 1/4	4,90	51,46	9,37	2,35	81,95	2,97	20,97	1,50	-30,49	3	3	✓
L 3 x 3 x 5/16	6,10	61,99	11,38	2,32	98,50	2,92	25,48	1,49	-36,51	1	3	✓
L 3 x 3 x 3/8	7,20	72,92	13,57	2,31	115,7	2,91	30,15	1,49	-42,77	1	1	✓
L 3 x 3 x 7/16	8,30	82,18	15,43	2,28	130,0	2,87	34,34	1,48	-47,84	1	1	✓
L 3 x 3 x 1/2	9,40	91,40	17,35	2,27	144,1	2,84	38,66	1,47	-52,74	1	1	✓
L 3 1/2 x 3 1/2 x 1/4	5,80	82,51	12,76	2,74	131,3	3,46	33,72	1,75	-48,79	3	4	✓
L 3 1/2 x 3 1/2 x 5/16	7,20	100,5	15,68	2,72	159,8	3,43	41,21	1,74	-59,29	3	3	✓
L 3 1/2 x 3 1/2 x 3/8	8,50	118,8	18,78	2,72	188,9	3,43	48,71	1,74	-70,09	1	3	✓
L 3 1/2 x 3 1/2 x 7/16	9,80	135,2	21,57	2,70	214,6	3,40	55,84	1,74	-79,36	1	1	✓
L 3 1/2 x 3 1/2 x 1/2	11,1	150,9	24,30	2,68	238,8	3,37	62,96	1,73	-87,94	1	1	✓
L 4 x 4 x 1/4	6,60	125,9	17,02	3,17	200,8	4,00	50,99	2,02	-74,91	3	4	✓
L 4 x 4 x 5/16	8,20	154,0	20,99	3,15	245,5	3,98	62,54	2,01	-91,46	3	3	✓
L 4 x 4 x 3/8	9,80	180,0	24,68	3,12	286,3	3,93	73,70	1,99	-106,3	2	3	✓
L 4 x 4 x 7/16	11,3	206,5	28,61	3,11	328,3	3,92	84,70	1,99	-121,8	1	3	✓
L 4 x 4 x 1/2	12,8	230,9	32,24	3,09	366,4	3,89	95,40	1,99	-135,5	1	1	✓
L 4 x 4 x 5/8	15,7	276,6	39,26	3,05	436,9	3,83	116,3	1,98	-160,3	1	1	✓
L 4 x 4 x 3/4	18,5	318,9	46,00	3,02	500,7	3,78	137,1	1,98	-181,8	1	1	✓
L 5 x 5 x 5/16	10,3	308,3	33,37	3,97	492,1	5,02	124,5	2,52	-183,8	3	4	✓
L 5 x 5 x 3/8	12,3	363,4	39,59	3,95	579,6	4,99	147,2	2,51	-216,2	3	4	✓
L 5 x 5 x 7/16	14,3	414,2	45,32	3,91	659,3	4,93	169,1	2,50	-245,1	3	3	✓
L 5 x 5 x 1/2	16,2	466,0	51,36	3,90	741,3	4,91	190,7	2,49	-275,3	1	3	✓
L 5 x 5 x 5/8	20,0	564,2	63,00	3,86	894,9	4,86	233,5	2,48	-330,7	1	1	✓
L 5 x 5 x 3/4	23,6	654,7	74,12	3,82	1035	4,81	274,1	2,47	-380,6	1	1	✓
L 5 x 5 x 7/8	27,2	737,8	84,58	3,78	1162	4,75	314,1	2,47	-423,7	1	1	✓

Perfiles americanos angulares de lados iguales (continúa)

Dimensiones: ASTM A 6/A 6M - 07
Tolerancias: ASTM A 6/A 6M - 07
Estado de la superficie: conforme a ASTM A 6/A 6M - 07

American equal leg angles (continued)

Dimensions: ASTM A 6/A 6M - 07
Tolerances: ASTM A 6/A 6M - 07
Surface condition: according to ASTM A 6/A 6M - 07

Angolari a lati uguali (continua)

Dimensioni: ASTM A 6/A 6M - 07
Tolleranze: ASTM A 6/A 6M - 07
Condizioni di superficie: conformi ad ASTM A 6/A 6M - 07

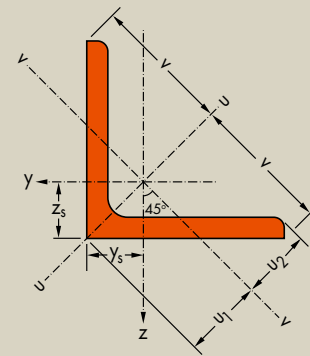
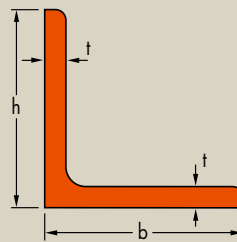

Denominación Designation Designazione (metric)	Dimensiones Dimensions Dimensioni			A	Posición de ejes Position of axes Posizione degli assi				Superficie Surface Superficie	
	h = b	t			$z_s = y_s$	v	u_1	u_2	A_L	A_G
G	mm	mm		mm ² x10 ²	mm x10	mm x10	mm x10	mm x10	m ² /m	m ² /t
L 152 x 152 x 7.9 ^{v/*}	18,5	152	7,94	23,6	4,09	10,78	5,78	5,43	0,604	32,65
L 152 x 152 x 9.5 ^{v/*}	22,2	152	9,53	28,1	4,14	10,78	5,85	5,43	0,602	27,12
L 152 x 152 x 11.1 ^{v/*}	25,6	152	11,1	32,7	4,21	10,78	5,96	5,50	0,605	23,63
L 152 x 152 x 12.7 ^{v/*}	29,2	152	12,7	37,1	4,26	10,78	6,03	5,48	0,603	20,65
L 152 x 152 x 14.3 ^{v/*}	32,6	152	14,3	41,5	4,33	10,78	6,12	5,56	0,605	18,56
L 152 x 152 x 15.9 ^{v/*}	36,0	152	15,9	45,9	4,39	10,78	6,21	5,59	0,605	16,81
L 152 x 152 x 19.0 ^{v/*}	42,7	152	19,1	54,5	4,51	10,78	6,37	5,67	0,606	14,19
L 152 x 152 x 22.2 ^{v/*}	49,3	152	22,2	62,8	4,62	10,78	6,53	5,71	0,605	12,27
L 152 x 152 x 25.4 ^{v/*}	55,7	152	25,4	71,0	4,73	10,78	6,69	5,78	0,605	10,86
L 203 x 203 x 12.7 ^{v/*}	39,3	203	12,7	50,0	5,54	14,37	7,84	7,30	0,808	20,56
L 203 x 203 x 14.3 ^{v/*}	44,0	203	14,3	56,0	5,60	14,37	7,92	7,35	0,809	18,39
L 203 x 203 x 15.9 ^{v/*}	48,7	203	15,9	62,0	5,66	14,37	8,01	7,38	0,809	16,61
L 203 x 203 x 19.0 ^{v/*}	57,9	203	19,1	73,6	5,78	14,37	8,17	7,44	0,809	13,97
L 203 x 203 x 22.2 ^{v/*}	67,0	203	22,2	85,0	5,89	14,37	8,33	7,51	0,809	12,07
L 203 x 203 x 25.4 ^{v/*}	75,9	203	25,4	96,8	6,00	14,37	8,49	7,47	0,807	10,63
L 203 x 203 x 28.6 ^{v/*}	84,7	203	28,6	108	6,12	14,37	8,65	7,57	0,808	9,54

^v Otras dimensiones previa solicitud.
* Tonelaje mínimo y condiciones de suministro previo acuerdo.

^v Other dimensions on request.
* Minimum tonnage and delivery conditions upon agreement.

^v Dimensioni di dettaglio disponibili su richiesta.
* Tonnellaggio minimo e condizioni di fornitura da concordare.



Páginas de notaciones 199-203 / Notations pages 199-203 / Pagine di annotazioni 199-203

Denominación Designation Designazione (imperial)	Propiedades de perfil / Section properties / Proprietà geometriche del profilo									Classification EN 1993-1-1: 2005		A572/A709/A992
	eje y-y / eje z-z axis y-y / axis z-z asse y-y / asse z-z			eje u-u axis u-u asse u-u		eje v-v axis v-v asse v-v		pure compression				
	$I_y = I_z$	$W_{el,y} = W_{el,z}$	$i_y = i_z$	I_u	i_u	I_v	i_v	I_{yz}	S235	S355		
G lbs/ft	mm ⁴ x10 ⁴	mm ³ x10 ³	mm x10	mm ⁴ x10 ⁴	mm x10	mm ⁴ x10 ⁴	mm x10	mm ⁴ x10 ⁴				
L 6 x 6 x 5/16	12,4	540,0	48,42	4,78	861,9	6,04	218,1	3,04	-321,9	4	4	✓
L 6 x 6 x 3/8	14,9	637,5	57,41	4,75	1016	6,00	258,9	3,03	-378,6	3	4	✓
L 6 x 6 x 7/16	17,2	734,7	66,63	4,74	1172	5,99	297,5	3,02	-437,2	3	4	✓
L 6 x 6 x 1/2	19,6	825,3	75,18	4,71	1315	5,95	335,8	3,01	-489,5	3	3	✓
L 6 x 6 x 9/16	21,9	917,2	84,08	4,70	1461	5,93	373,7	3,00	-543,5	2	3	✓
L 6 x 6 x 5/8	24,2	1004	92,53	4,68	1598	5,90	410,5	2,99	-593,5	1	3	✓
L 6 x 6 x 3/4	28,7	1171	109,1	4,64	1859	5,84	483,3	2,98	-687,7	1	1	✓
L 6 x 6 x 7/8	33,1	1327	124,9	4,60	2100	5,78	554,1	2,97	-772,9	1	1	✓
L 6 x 6 x 1	37,4	1475	140,4	4,56	2326	5,72	624,4	2,97	-850,6	1	1	✓
L 8 x 8 x 1/2	26,4	2021	136,7	6,36	3226	8,03	816,0	4,04	-1205	3	4	✓
L 8 x 8 x 9/16	29,6	2249	152,8	6,33	3589	8,00	909,0	4,03	-1340	3	4	✓
L 8 x 8 x 5/8	32,7	2471	168,6	6,31	3941	7,97	1001	4,02	-1470	3	3	✓
L 8 x 8 x 3/4	38,9	2900	199,4	6,27	4619	7,91	1181	4,00	-1719	2	3	✓
L 8 x 8 x 7/8	45,0	3310	229,4	6,23	5264	7,85	1356	3,99	-1954	1	3	✓
L 8 x 8 x 1	51,0	3693	258,0	6,18	5863	7,79	1523	3,97	-2170	1	1	✓
L 8 x 8 x 1 1/8	56,9	4071	286,7	6,14	6448	7,73	1694	3,96	-2377	1	1	✓

Perfiles americanos angulares de lados iguales (continúa)

Dimensiones: ASTM A 6/A 6M - 07

Tolerancias: ASTM A 6/A 6M - 07

Estado de la superficie: conforme a ASTM A 6/A 6M - 07

American equal leg angles (continued)

Dimensions: ASTM A 6/A 6M - 07

Tolerances: ASTM A 6/A 6M - 07

Surface condition: according to ASTM A 6/A 6M - 07

Angolari a lati uguali (continua)

Dimensioni: ASTM A 6/A 6M - 07

Tolleranze: ASTM A 6/A 6M - 07

Condizioni di superficie: conformi ad ASTM A 6/A 6M - 07

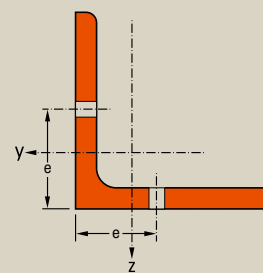
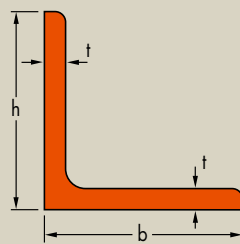

Denominación Designation Designazione (metric)	Dimensiones Dimensions Dimensioni			Dimensiones de construcción Dimensions for detailing Dimensioni di dettaglio				
	G kg/m	h = b mm	t mm	A mm ² x10 ²	Ø	e _{min} mm	e _{max} mm	A _{net} mm ² x10 ²
L 19 x 19 x 3.2 [∇] / [*]	0,9	19,05	3,2	1	-	-	-	-
L 25 x 25 x 3.2 [∇] / [*]	1,2	25,4	3,18	1,51	-	-	-	-
L 25 x 25 x 4.8 [∇] / [*]	1,8	25,4	4,76	2,19	-	-	-	-
L 25 x 25 x 6.4 [∇] / [*]	2,2	25,4	6,35	2,83	-	-	-	-
L 32 x 32 x 3.2 [∇] / [*]	1,5	31,75	3,18	1,92	-	-	-	-
L 32 x 32 x 4.8 [∇] / [*]	2,2	31,75	4,76	2,8	-	-	-	-
L 32 x 32 x 6.4 [∇] / [*]	2,8	31,75	6,35	3,63	-	-	-	-
L 38 x 38 x 3.2 [∇] / [*]	1,8	38,1	3,18	2,32	-	-	-	-
L 38 x 38 x 4.0 [∇] / [*]	2,2	38,1	3,97	2,86	-	-	-	-
L 38 x 38 x 4.8 [∇] / [*]	2,7	38,1	4,76	3,4	-	-	-	-
L 38 x 38 x 6.4 [∇] / [*]	3,4	38,1	6,35	4,44	-	-	-	-
L 44 x 44 x 3.2 [∇] / [*]	2,1	44,45	3,18	2,72	-	-	-	-
L 44 x 44 x 4.8 [∇] / [*]	3,1	44,45	4,76	4,01	-	-	-	-
L 44 x 44 x 6.4 [∇] / [*]	4,1	44,45	6,35	5,25	-	-	-	-
L 51 x 51 x 3.2 [∇] / [*]	2,4	50,8	3,18	3,12	-	-	-	-
L 51 x 51 x 4.8 [∇] / [*]	3,6	50,8	4,76	4,61	-	-	-	-
L 51 x 51 x 6.4 [∇] / [*]	4,7	50,8	6,35	6,05	-	-	-	-
L 51 x 51 x 7.9 [∇] / [*]	5,8	50,8	7,94	7,42	-	-	-	-
L 51 x 51 x 9.5 [∇] / [*]	7	50,8	9,53	8,77	-	-	-	-
L 64 x 64 x 4.8 [∇] / [*]	4,6	63,5	4,76	5,81	M16	34,76	36,5	4,96
L 64 x 64 x 6.4 [∇] / [*]	6,1	63,5	6,35	7,68	M16	36,35	36,5	6,52
L 64 x 64 x 7.9 [∇] / [*]	7,4	63,5	7,94	9,42	M12	37,94	44	8,42
L 64 x 64 x 9.5 [∇] / [*]	8,7	63,5	9,53	11,2	M12	39,53	44	9,95
L 64 x 64 x 12.7 [∇] / [*]	11,4	63,5	12,7	14,5	M12	42,7	44	12,87

∇ Otras dimensiones previa solicitud.
* Tonelaje mínimo y condiciones de suministro previo acuerdo.

∇ Other dimensions on request.
* Minimum tonnage and delivery conditions upon agreement.

∇ Dimensioni di dettaglio disponibili su richiesta.
* Tonnellaggio minimo e condizioni di fornitura da concordare.



Páginas de notaciones 199-203 / Notations pages 199-203 / Pagine di annotazioni 199-203

Denominación Designation Designazione (metric)	Dimensiones Dimensions Dimensioni			Dimensiones de construcción Dimensions for detailing Dimensioni di dettaglio				
	G kg/m	h = b mm	t mm	A mm ² x10 ²	Ø	e _{min} mm	e _{max} mm	A _{net} mm ² x10 ²
L 76 x 76 x 4.8 ^{v/*}	5,5	76,2	4,76	7,03	M16	34,76	49,2	6,17
L 76 x 76 x 6.4 ^{v/*}	7,3	76,2	6,35	9,29	M16	36,35	49,2	8,13
L 76 x 76 x 7.9 ^{v/*}	9,1	76,2	7,94	11,5	M16	37,94	49,2	10,04
L 76 x 76 x 9.5 ^{v/*}	10,7	76,2	9,53	13,6	M16	39,53	49,2	11,89
L 76 x 76 x 11.1 ^{v/*}	12,4	76,2	11,1	15,7	M16	41,11	49,2	13,7
L 76 x 76 x 12.7 ^{v/*}	14	76,2	12,7	17,7	M16	42,7	49,2	15,46
L 89 x 89 x 6.4 ^{v/*}	8,6	88,9	6,35	10,9	M24	46,35	49,9	9,24
L 89 x 89 x 7.9 ^{v/*}	10,7	88,9	7,94	13,5	M24	47,94	49,9	11,42
L 89 x 89 x 9.5 ^{v/*}	12,6	88,9	9,53	16	M24	49,53	49,9	13,55
L 89 x 89 x 11.1 ^{v/*}	14,6	88,9	11,1	18,5	M22	51,11	52,9	15,86
L 89 x 89 x 12.7 ^{v/*}	16,5	88,9	12,7	21	M22	52,7	52,9	17,92
L 102 x 102 x 6.4 ^{v/*}	9,8	101,6	6,35	12,5	M27	46,35	56,6	10,59
L 102 x 102 x 7.9 ^{v/*}	12,2	101,6	7,94	15,5	M27	47,94	56,6	13,12
L 102 x 102 x 9.5 ^{v/*}	14,6	101,6	9,53	18,5	M27	49,53	56,6	15,59
L 102 x 102 x 11.1 ^{v/*}	16,8	101,6	11,1	21,4	M27	51,11	56,6	18,01
L 102 x 102 x 12.7 ^{v/*}	19	101,6	12,7	24,2	M27	52,7	56,6	20,38
L 102 x 102 x 15.9 ^{v/*}	23,4	101,6	15,9	29,7	M27	55,88	56,6	24,98
L 102 x 102 x 19.0 ^{v/*}	27,5	101,6	19,1	35,1	M24	59,05	62,6	30,13
L 127 x 127 x 7.9 ^{v/*}	15,3	127	7,94	19,6	M27	47,94	82	17,15
L 127 x 127 x 9.5 ^{v/*}	18,3	127	9,53	23,3	M27	49,53	82	20,43
L 127 x 127 x 11.1 ^{v/*}	21,3	127	11,1	27	M27	51,11	82	23,66
L 127 x 127 x 12.7 ^{v/*}	24,1	127	12,7	30,7	M27	52,7	82	26,84
L 127 x 127 x 15.9 ^{v/*}	29,8	127	15,9	37,8	M27	55,88	82	33,04
L 127 x 127 x 19.0 ^{v/*}	35,1	127	19,1	44,8	M27	59,05	82	39,04
L 127 x 127 x 22.2 ^{v/*}	40,5	127	22,2	51,5	M27	62,23	82	44,84

Perfiles americanos angulares de lados iguales (continúa)

Dimensiones: ASTM A 6/A 6M - 07
Tolerancias: ASTM A 6/A 6M - 07
Estado de la superficie: conforme a ASTM A 6/A 6M - 07

American equal leg angles (continued)

Dimensions: ASTM A 6/A 6M - 07
Tolerances: ASTM A 6/A 6M - 07
Surface condition: according to ASTM A 6/A 6M - 07

Angolari a lati uguali (continua)

Dimensioni: ASTM A 6/A 6M - 07
Tolleranze: ASTM A 6/A 6M - 07
Condizioni di superficie: conformi ad ASTM A 6/A 6M - 07

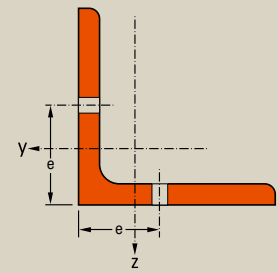
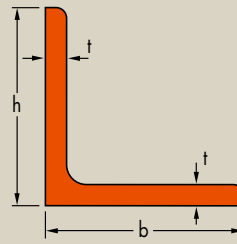

Denominación Designation Designazione (metric)	Dimensiones Dimensions Dimensioni		A	Ø	Dimensiones de construcción Dimensions for detailing Dimensioni di dettaglio		
	h = b	t			e _{min}	e _{max}	A _{net}
G	mm	mm	mm ² x10 ²		mm	mm	mm ² x10 ²

L 152 x 152 x 7.9 ^{∇*}	18,5	152,4	7,94	23,6	M27	47,94	107,4	21,18
L 152 x 152 x 9.5 ^{∇*}	22,2	152,4	9,53	28,1	M27	49,53	107,4	25,27
L 152 x 152 x 11.1 ^{∇*}	25,6	152,4	11,1	32,7	M27	51,11	107,4	29,3
L 152 x 152 x 12.7 ^{∇*}	29,2	152,4	12,7	37,1	M27	52,7	107,4	33,29
L 152 x 152 x 14.3 ^{∇*}	32,6	152,4	14,3	41,5	M27	54,29	107,4	37,22
L 152 x 152 x 15.9 ^{∇*}	36	152,4	15,9	45,9	M27	55,88	107,4	41,1
L 152 x 152 x 19.0 ^{∇*}	42,7	152,4	19,1	54,5	M27	59,05	107,4	48,72
L 152 x 152 x 22.2 ^{∇*}	49,3	152,4	22,2	62,8	M27	62,23	107,4	56,13
L 152 x 152 x 25.4 ^{∇*}	55,7	152,4	25,4	71	M27	65,4	107,4	63,35
L 203 x 203 x 12.7 ^{∇*}	39,3	203,2	12,7	50	M27	52,7	158,2	46,19
L 203 x 203 x 14.3 ^{∇*}	44	203,2	14,3	56	M27	54,29	158,2	51,74
L 203 x 203 x 15.9 ^{∇*}	48,7	203,2	15,9	62	M27	55,88	158,2	57,23
L 203 x 203 x 19.0 ^{∇*}	57,9	203,2	19,1	73,6	M27	59,05	158,2	68,08
L 203 x 203 x 22.2 ^{∇*}	67	203,2	22,2	85	M27	62,23	158,2	78,72
L 203 x 203 x 25.4 ^{∇*}	75,9	203,2	25,4	96,8	M27	65,4	158,2	89,15
L 203 x 203 x 28.6 ^{∇*}	84,7	203,2	28,6	108	M27	68,58	158,2	99,39

∇ Otras dimensiones previa solicitud.
* Tonelaje mínimo y condiciones de suministro previo acuerdo.

∇ Other dimensions on request.
* Minimum tonnage and delivery conditions upon agreement.

∇ Dimensioni di dettaglio disponibili su richiesta.
* Tonnellaggio minimo e condizioni di fornitura da concordare.

Perfiles japoneses

Japanese sections

Profili giapponesi

154 Perfiles H japoneses

154 Japanese H sections

154 Profili H giapponesi



Perfiles H japoneses

Dimensiones: JIS G 3192: 2005; JIS A 5526: 2005
Tolerancias: JIS G 3192: 2005; JIS A 5526: 2005

Japanese H sections

Dimensions: JIS G 3192: 2005; JIS A 5526: 2005
Tolerances: JIS G 3192: 2005; JIS A 5526: 2005

Profili H giapponesi

Dimensioni: JIS G 3192: 2005; JIS A 5526: 2005
Tolleranze: JIS G 3192: 2005; JIS A 5526: 2005

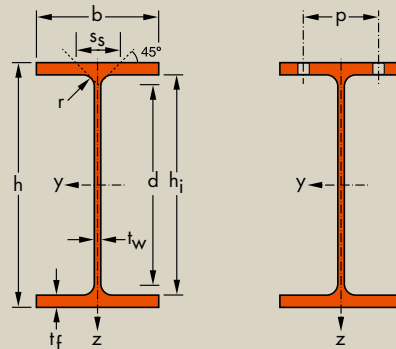

Denominación Designation Designazione	Dimensiones Dimension Dimensioni						A mm ² x10 ²	Dimensiones de construcción Dimensions for detailing Dimensioni di dettaglio					Superficie Surface Superficie	
	G kg/m	h mm	b mm	t _w mm	t _r mm	r mm		h _i mm	d mm	Ø	p _{min} mm	p _{max} mm	A _L m ² /m	A _G m ² /t
H 100 x 100 x 6 x 8*	16,9	100	100	6	8	8	21,59	84	68	M10	52	56	0,57	33,9
H 125 x 125 x 6,5 x 9*	23,6	125	125	6,5	9	8	30,00	107	91	M16	56	62	0,72	30,7
H 150 x 75 x 5 x 7*	14,0	150	75	5	7	8	17,85	136	120	-	-	-	0,58	41,1
H 150 x 150 x 7 x 10*	31,1	150	150	7	10	8	39,65	130	114	M20	72	76	0,87	28,0
H 175 x 175 x 7,5 x 11*	40,4	175	175	7,5	11	13	51,42	153	127	M24	82	88	1,01	25,1
H 200 x 100 x 4,5 x 7*	17,8	198	99	4,5	7	8	22,69	184	168	M10	54	56	0,77	43,2
H 200 x 100 x 5,5 x 8*	20,9	200	100	5,5	8	8	26,67	184	168	M10	54	56	0,78	37,0
H 200 x 150 x 6 x 9*	29,9	194	150	6	9	8	38,11	176	160	M20	66	76	0,96	32,2
H 200 x 200 x 8 x 12 [□] /*	49,9	200	200	8	12	13	63,53	176	150	M27	92	102	1,16	23,3
H 250 x 125 x 5 x 8*	25,1	248	124	5	8	8	31,99	232	216	M12	58	74	0,97	38,6
H 250 x 125 x 6 x 9*	29,0	250	125	6	9	8	36,97	232	216	M12	58	74	0,97	33,6
H 250 x 250 x 9 x 14 [□] /*	71,8	250	250	9	14	13	91,43	222	196	M27	100	150	1,46	20,3
H 300 x 150 x 5,5 x 8*	32,0	298	149	5,5	8	13	40,80	282	256	M16	76	86	1,16	36,2
H 300 x 150 x 6,5 x 9*	36,7	300	150	6,5	9	13	46,78	282	256	M16	76	88	1,17	31,7
H 300 x 200 x 8 x 12*	55,8	294	200	8	12	13	71,05	270	244	M27	90	102	1,35	24,2
H 300 x 300 x 10 x 15 [□] /*	93,0	300	300	10	15	13	118,5	270	244	M27	102	200	1,76	18,9
H 350 x 175 x 6 x 9*	41,2	346	174	6	9	13	52,45	328	302	M22	90	92	1,35	32,9
H 350 x 175 x 7 x 11*	49,4	350	175	7	11	13	62,91	328	302	M22	92	92	1,36	27,6
H 350 x 350 x 10 x 16 [□] /*	113	344	348	10	16	13	144,0	312	286	M27	106	248	2,04	18,0
H 350 x 350 x 12 x 19 [□] /*	135	350	350	12	19	13	171,9	312	286	M27	108	248	2,05	15,2

* Tonelaje mínimo y condiciones de suministro previo acuerdo.
□ Perfil conforme a JIS A 5526: 2005

* Minimum tonnage and delivery conditions upon agreement.
□ Section in accordance with JIS A 5526: 2005

* Tonnellaggio minimo e condizioni di fornitura da concordare.
□ Sezione conforme a JIS 5526: 2005



Páginas de notaciones 199-203 / Notations pages 199-203 / Pagine di annotazioni 199-203

Denominación Designation Designazione	Propiedades de perfil / Section properties / Proprietà geometriche del profilo													Classification EN 1993-1-1: 2005						JIS G 3101 - 2004	JIS G 3106 - 2004
	G kg/m	eje fuerte y-y strong axis y-y asse forte y-y					eje débil z-z weak axis z-z asse debole z-z					Pure bending y-y			Pure compression						
		I_y mm ⁴ x10 ⁴	$W_{el,y}$ mm ³ x10 ³	$W_{pl,y}♦$ mm ³ x10 ³	i_y mm x10	A_{vz} mm ² x10 ²	I_z mm ⁴ x10 ⁴	$W_{el,z}$ mm ³ x10 ³	$W_{pl,z}♦$ mm ³ x10 ³	i_z mm x10	s_s mm	I_t mm ⁴ x10 ⁴	I_w mm ⁶ x10 ⁹	S235	S355	S460	S235	S355	S460		
H 100 x 100 x 6 x 8	16,9	378	75,6	86,4	4,18	7,35	134	26,7	41,0	2,49	31,4	4,91	2,82	1	1	-	1	1	-	✓	✓
H 125 x 125 x 6.5 x 9	23,6	839	134	152	5,29	9,53	293	46,9	71,7	3,13	33,9	8,10	9,86	1	1	-	1	1	-	✓	✓
H 150 x 75 x 5 x 7	14,0	666	88,8	102	6,11	8,82	49,5	13,2	20,8	1,66	28,4	2,90	2,52	1	1	-	1	1	-	✓	✓
H 150 x 150 x 7 x 10	31,1	1620	216	243	6,40	12,0	563	75,1	114	3,77	36,4	12,7	27,6	1	1	-	1	1	-	✓	✓
H 175 x 175 x 7.5 x 11	40,4	2900	331	370	7,50	16,6	984	112	172	4,37	44,7	21,34	66,1	1	1	-	1	1	-	✓	✓
H 200 x 100 x 4.5 x 7	17,8	1540	156	175	8,25	10,3	113	22,9	35,5	2,24	27,9	3,32	10,3	1	1	-	2	4	-	✓	✓
H 200 x 100 x 5.5 x 8	20,9	1810	181	205	8,23	12,4	134	26,7	41,6	2,24	30,9	5,17	12,3	1	1	-	1	2	-	✓	✓
H 200 x 150 x 6 x 9	29,9	2630	271	301	8,30	13,1	507	67,6	103	3,65	33,4	9,42	43,3	1	1	-	1	1	-	✓	✓
H 200 x 200 x 8 x 12	49,9	4720	472	525	8,62	19,6	1600	160	244	5,02	47,2	30,16	141	1	1	-	1	1	-	✓	✓
H 250 x 125 x 5 x 8	25,1	3450	278	312	10,4	13,8	255	41,1	63,2	2,82	30,4	5,80	36,6	1	1	-	4	4	-	✓	✓
H 250 x 125 x 6 x 9	29,0	3960	317	358	10,4	16,5	294	47,0	72,7	2,82	33,4	8,61	42,5	1	1	-	2	4	-	✓	✓
H 250 x 250 x 9 x 14	71,8	10700	860	953	10,8	26,3	3650	292	443	6,32	52,2	56,24	508	1	2	-	1	2	-	✓	✓
H 300 x 150 x 5.5 x 8	32,0	6320	424	475	12,4	19,5	442	59,3	91,8	3,29	36,7	8,79	92,7	1	2	-	4	4	-	✓	✓
H 300 x 150 x 6.5 x 9	36,7	7210	481	542	12,4	22,7	508	67,7	105	3,29	39,7	12,73	107	1	1	-	3	4	-	✓	✓
H 300 x 200 x 8 x 12	55,8	11100	756	842	12,5	27,1	1600	160	245	4,75	47,2	31,8	318	1	1	-	1	2	-	✓	✓
H 300 x 300 x 10 x 15	93,0	20200	1350	1480	13,1	33,9	6750	450	683	7,55	55,2	82,87	1370	1	3	-	1	3	-	✓	✓
H 350 x 175 x 6 x 9	41,2	11000	638	712	14,5	24,0	791	91,0	140	3,88	39,2	13,28	224	1	2	-	4	4	-	✓	✓
H 350 x 175 x 7 x 11	49,4	13500	771	864	14,6	28,0	984	112	173	3,96	44,2	22,47	282	1	1	-	4	4	-	✓	✓
H 350 x 350 x 10 x 16	113	32800	1910	2090	15,1	38,4	11240	646	978	8,84	57,2	111,6	3020	2	3	-	2	3	-	✓	✓
H 350 x 350 x 12 x 19	135	39800	2280	2520	15,2	46,1	13600	776	1180	8,89	65,2	186,9	3720	1	3	-	1	3	-	✓	✓

♦ W_{pl} : para el diseño plástico la sección debe pertenecer a la clase 1 o 2 según la capacidad de rotación que se precise. Véase pág. 203.

♦ W_{pl} : for plastic design, the shape must belong to class 1 or 2 according to the required rotation capacity. See page 203.

♦ W_{pl} : per il calcolo plastico, la sezione trasversale deve appartenere alla classe 1 o 2, conformemente alla capacità di rotazione richiesta. Vedere pagina 203.

Perfiles H japoneses (continúa)

Dimensiones: JIS G 3192: 2005; JIS A 5526: 2005
Tolerancias: JIS G 3192: 2005; JIS A 5526: 2005

Japanese H sections (continued)

Dimensions: JIS G 3192: 2005; JIS A 5526: 2005
Tolerances: JIS G 3192: 2005; JIS A 5526: 2005

Profili H giapponesi (continua)

Dimensioni: JIS G 3192: 2005; JIS A 5526: 2005
Tolleranze: JIS G 3192: 2005; JIS A 5526: 2005

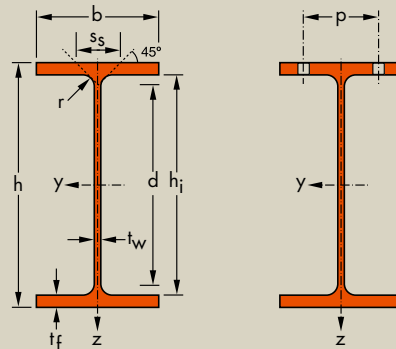

Denominación Designation Designazione	G kg/m	Dimensiones Dimension Dimensioni					A mm ² ×10 ²	Dimensiones de construcción Dimensions for detailing Dimensioni di dettaglio					Superficie Surface Superficie	
		h mm	b mm	t _w mm	t _r mm	r mm		h _i mm	d mm	Ø	p _{min} mm	p _{max} mm	A _L m ² /m	A _G m ² /t
H 400 x 200 x 7 x 11*	56,1	396	199	7	11	13	71,41	374	348	M27	90	98	1,55	27,7
H 400 x 200 x 8 x 13*	65,4	400	200	8	13	13	83,37	374	348	M27	90	100	1,56	23,9
H 400 x 300 x 10 x 16*	105	390	300	10	16	13	133,2	358	332	M27	110	200	1,94	18,5
H 400 x 400 x 13 x 21 [□] *	172	400	400	13	21	22	218,7	358	314	M27	114	298	2,34	13,6
H 400 x 400 x 21 x 21 [□] *	197	400	408	21	21	22	250,7	358	314	M27	122	306	2,35	12,0
H 400 x 400 x 18 x 28 [□] *	232	414	405	18	28	22	295,4	358	314	M27	118	302	2,37	10,2
H 400 x 400 x 20 x 35 [□] *	283	428	407	20	35	22	360,7	358	314	M27	120	304	2,41	8,50
H 400 x 400 x 30 x 50 [□] *	415	458	417	30	50	22	528,6	358	314	M27	130	316	2,49	5,99
H 500 x 200 x 9 x 14*	77,9	496	199	9	14	13	99,29	468	442	M24	100	110	1,75	22,4
H 500 x 200 x 10 x 16*	88,2	500	200	10	16	13	112,2	468	442	M24	102	112	1,76	20,0
H 500 x 300 x 11 x 15*	111	482	300	11	15	13	141,2	452	426	M27	118	200	2,12	19,1
H 500 x 300 x 11 x 18*	125	488	300	11	18	13	159,2	452	426	M27	118	200	2,13	17,1
H 600 x 300 x 12 x 17*	133	582	300	12	17	13	169,2	548	522	M27	124	200	2,32	17,5
H 600 x 300 x 12 x 20*	147	588	300	12	20	13	187,2	548	522	M27	124	200	2,33	15,9
H 600 x 300 x 14 x 23*	170	594	302	14	23	13	217,1	548	522	M27	126	202	2,35	13,8
H 700 x 300 x 13 x 20*	163	692	300	13	20	18	207,5	652	616	M27	124	200	2,53	15,5
H 700 x 300 x 13 x 24*	182	700	300	13	24	18	231,5	652	616	M27	124	200	2,54	14,0
H 800 x 300 x 14 x 22*	188	792	300	14	22	18	239,5	748	712	M27	126	200	2,73	14,5
H 800 x 300 x 14 x 26*	207	800	300	14	26	18	263,5	748	712	M27	126	200	2,74	13,3
H 900 x 300 x 15 x 23*	210	890	299	15	23	18	266,9	844	808	M27	126	198	2,92	13,9
H 900 x 300 x 16 x 28*	240	900	300	16	28	18	305,8	844	808	M27	128	200	2,94	12,2
H 900 x 300 x 18 x 34*	283	912	302	18	34	18	360,1	844	808	M27	130	202	2,97	10,5

* Tonelaje mínimo y condiciones de suministro previo acuerdo.
□ Perfil conforme a JIS A 5526: 2005

* Minimum tonnage and delivery conditions upon agreement.
□ Section in accordance with JIS A 5526: 2005

* Tonnellaggio minimo e condizioni di fornitura da concordare.
□ Sezione conforme a JIS 5526: 2005



Páginas de notaciones 199-203 / Notations pages 199-203 / Pagine di annotazioni 199-203

Denominación Designation Designazione	Propiedades de perfil / Section properties / Proprietà geometriche del profilo												Classification EN 1993-1-1: 2005						JIS G 3101 - 2004	JIS G 3106 - 2004	
	G kg/m	eje fuerte y-y strong axis y-y asse forte y-y					eje débil z-z weak axis z-z asse debole z-z					Pure bending y-y			Pure compression						
		I_y mm ⁴ x10 ⁴	$W_{el,y}$ mm ³ x10 ³	$W_{pl,y}♦$ mm ³ x10 ³	i_y mm x10	A_{vz} mm ² x10 ²	I_z mm ⁴ x10 ⁴	$W_{el,z}$ mm ³ x10 ³	$W_{pl,z}♦$ mm ³ x10 ³	i_z mm x10	s_s mm	I_t mm ⁴ x10 ⁴	I_w mm ⁶ x10 ⁹	S235	S355	S460	S235	S355			S460
H 400 x 200 x 7 x 11	56	19800	999	1110	16,6	31,3	1450	145	223	4,50	44,2	25,12	535	1	2	-	4	4	-	✓	✓
H 400 x 200 x 8 x 13	65	23500	1170	1310	16,8	35,8	1740	174	267	4,56	49,2	39,7	649	1	1	-	4	4	-	✓	✓
H 400 x 300 x 10 x 16	105	37900	1940	2140	16,9	43,0	7200	480	730	7,35	57,2	100	2520	1	3	-	2	3	-	✓	✓
H 400 x 400 x 13 x 21	172	66600	3330	3670	17,5	62,7	22400	1120	1700	10,1	80,8	303,9	8040	1	3	-	1	3	-	✓	✓
H 400 x 400 x 21 x 21	197	70900	3540	3990	16,8	93,0	23800	1170	1800	9,75	88,8	450,4	8540	1	3	-	1	3	-	✓	✓
H 400 x 400 x 18 x 28	232	92800	4480	5030	17,7	86,0	31000	1530	2330	10,2	99,8	720	11500	1	1	-	1	1	-	✓	✓
H 400 x 400 x 20 x 35	283	119000	5570	6310	18,2	98,2	39400	1930	2940	10,4	116	1320	15200	1	1	-	1	1	-	✓	✓
H 400 x 400 x 30 x 50	415	187000	8170	9540	18,8	149	60500	2900	4440	10,7	156	3930	25100	1	1	-	1	1	-	✓	✓
H 500 x 200 x 9 x 14	77,9	40800	1650	1870	20,3	48,5	1840	185	288	4,31	52,2	52,89	1070	1	1	-	4	4	-	✓	✓
H 500 x 200 x 10 x 16	88,2	46800	1870	2130	20,4	54,0	2140	214	333	4,36	57,2	76,4	1250	1	1	-	4	4	-	✓	✓
H 500 x 300 x 11 x 15	111	58300	2420	2700	20,3	56,7	6760	450	690	6,92	56,2	95,52	3680	1	3	-	3	4	-	✓	✓
H 500 x 300 x 11 x 18	125	68900	2820	3130	20,8	57,8	8110	540	825	7,14	62,2	144	4470	1	1	-	3	4	-	✓	✓
H 600 x 300 x 12 x 17	133	98900	3400	3820	24,2	73,7	7660	511	786	6,73	61,2	139,3	6110	1	2	-	4	4	-	✓	✓
H 600 x 300 x 12 x 20	147	114000	3890	4350	24,7	74,8	9010	601	921	6,94	67,2	200	7260	1	1	-	4	4	-	✓	✓
H 600 x 300 x 14 x 23	170	134000	4500	5060	24,8	87,4	10600	700	1080	6,98	75,2	306	8610	1	1	-	2	4	-	✓	✓
H 700 x 300 x 13 x 20	163	168000	4870	5500	28,5	97,3	9020	601	930	6,59	74,1	228,2	10200	1	1	-	4	4	-	✓	✓
H 700 x 300 x 13 x 24	182	197000	5640	6340	29,2	99,3	10800	721	1110	6,83	82,1	342,2	12300	1	1	-	4	4	-	✓	✓
H 800 x 300 x 14 x 22	188	248000	6270	7140	32,2	119	9920	661	1030	6,44	79,1	304,9	14700	1	1	-	4	4	-	✓	✓
H 800 x 300 x 14 x 26	207	286000	7160	8100	33,0	121	11700	781	1210	6,67	87,1	439,8	17500	1	1	-	4	4	-	✓	✓
H 900 x 300 x 15 x 23	210	339000	7610	8750	35,6	141	10300	687	1080	6,20	82,1	364,7	19300	1	1	-	4	4	-	✓	✓
H 900 x 300 x 16 x 28	240	404000	8990	10300	36,4	152	12600	842	1320	6,43	93,1	581,4	24000	1	1	-	4	4	-	✓	✓
H 900 x 300 x 18 x 34	283	491000	10800	12300	36,9	173	15700	1040	1620	6,59	107	980,8	30100	1	1	-	4	4	-	✓	✓

♦ W_{pl} : para el diseño plástico la sección debe pertenecer a la clase 1 o 2 según la capacidad de rotación que se precise. Véase pág. 203.

♦ W_{pl} : for plastic design, the shape must belong to class 1 or 2 according to the required rotation capacity. See page 203.

♦ W_{pl} : per il calcolo plastico, la sezione trasversale deve appartenere alla classe 1 o 2, conformemente alla capacità di rotazione richiesta. Vedere pagina 203.



Grados y calidades de acero

- 166 1. Designaciones habituales de las calidades de acero estructural
- 167 2. Aceros estructurales no aleados según norma europea
- 169 3. Aceros estructurales soldables de grano fino según norma europea
- 171 4. Aceros para temple y revenido - aceros no aleados de alta calidad y aceros especiales no aleados
- 173 5. Aceros para cementación - aceros especiales no aleados
- 174 6. Aceros HISTAR® y FRITENAR® - Marcas registradas
- 176 7. Aceros estructurales soldables para estructuras offshore fijas según norma europea
- 178 8. Calidades de acero HISTAR® y FRITENAR® para aplicaciones offshore
- 180 9. Aceros estructurales con resistencia mejorada a la corrosión atmosférica según norma europea
- 182 10. Calidades de acero según normas americanas
- 184 11. Calidades de acero según normas japonesas
- 186 12. Tablas comparativas de las calidades típicas de acero

Steel grades and qualities

- 166 1. Usual structural steel grade designations
- 167 2. Non-alloy structural steels according to European standard
- 169 3. Weldable fine grain structural steels according to European standard
- 171 4. Steels for quenching and tempering - non alloy quality steels and non alloy special steels
- 173 5. Case hardening steels - non alloy special steels
- 174 6. HISTAR® and FRITENAR® Trademark Steels
- 176 7. Weldable structural steels for fixed offshore structures according to European standard
- 178 8. HISTAR® and FRITENAR® steel grades for offshore applications
- 180 9. Structural Steels with improved atmospheric corrosion resistance according to European standard
- 182 10. Steel grades according to American standards
- 184 11. Steel grades according to Japanese standards
- 186 12. Comparison tables of typical steel grades

Qualità e caratteristiche degli acciai

- 166 1. Designazione degli acciai strutturali
- 167 2. Acciai strutturali non legati in conformità alle norme europee
- 169 3. Acciai strutturali a grano fine saldabili in conformità alle norme europee
- 171 4. Acciai da bonifica e tempra - acciai non legati e acciai speciali non legati
- 173 5. Acciai da cementazione - acciai speciali non legati
- 174 6. Acciai con marchio di fabbrica HISTAR® e FRITENAR®
- 176 7. Acciai strutturali saldabili per strutture marine in conformità alle norme europee
- 178 8. Acciai con marchio di fabbrica HISTAR® e FRITENAR® per strutture marine (offshore)
- 180 9. Acciai strutturali con resistenza migliorata alla corrosione atmosferica in conformità alle norme europee
- 182 10. Tipi di acciai in conformità alle norme americane
- 184 11. Tipi di acciai in conformità alle norme giapponesi
- 186 12. Tavole comparative delle qualità di acciai

Grados y calidades de acero

Steel grades and qualities

Qualità e caratteristiche degli acciai

Sistema de designación de los aceros

La norma europea EN 10027-1:2005 define el sistema de designación del acero. Los símbolos habituales de los aceros estructurales aparecen relacionados en la tabla 1.

Aceros estructurales

Las calidades disponibles de acero estructural según las normas europeas, americanas y japonesas aparecen relacionadas en las tablas 2, 3 (EN), 10 (ASTM) y 11 (JIS). En estas tablas resumen se indican los requisitos principales de las normas en cuanto a las características mecánicas y composición química de las calidades de acero.

Previo solicitud están disponibles otras calidades de acero (normas canadienses CSA por ejemplo).

En la tabla 12 se muestra una lista de correspondencia de designaciones entre las normas europeas y las calidades HSTAR® y sus correspondientes designaciones americanas, canadienses, japonesas y nacionales europeas anteriores.

En términos generales, el acero suministrado tiene un contenido de silicio (Si) que oscila entre 0,14% y 0,25%, por lo que tiene la capacidad para formar una capa de zinc durante la galvanización por inmersión en baño caliente (diagrama 1). Dado que el contenido en fósforo de estos aceros es inferior normalmente al 0,035%, no ejerce ninguna influencia sobre el espesor final del recubrimiento en la franja de Si considerada.

Las características mecánicas de los perfiles fabricados por ArcelorMittal se optimizan mediante un control preciso de la temperatura durante el proceso de laminación. Frente a los aceros obtenidos mediante un laminado de normalización, estos aceros producidos

Designation system for steels

The European standard EN 10027-1:2005 defines the designation system for steel. The usual symbols for structural steels are shown in table 1.

Structural Steels

The available structural steel grades according to European, American and Japanese standards are shown in tables 2, 3 (EN), 10 (ASTM) and 11 (JIS). These summary tables show the main requirements of the standards regarding the mechanical characteristics and the chemical composition of the steel grades.

Other grades (Canadian CSA standards for instance) are available upon request.

Table 12 shows a list of corresponding designations between the European standards as well as the HSTAR® grades with those from the American, Canadian, Japanese and the former national European standards.

The steels are typically delivered with a Si content ranging between 0.14% and 0.25%, and are as such capable of forming a zinc layer during hot-dip galvanisation (diagram 1). As the phosphorus content of these steels is usually lower than 0.035%, it does not have any influence on the final thickness of the coating in the considered Si range.

The mechanical characteristics of ArcelorMittal's sections are improved by precise control of the temperature during the rolling process. These steels, produced using thermomechanical rolling (delivery condition M), feature improved toughness values thanks to a lower carbon equivalent and a fine microstructure when compared with normalised steels. With regard to their technological properties, the thermomechanically rolled steels have

Sistema di designazione degli acciai

La norma europea EN 10027-1: 2005 definisce il sistema di designazione degli acciai. I simboli per gli acciai strutturali sono illustrati nella tavola 1.

Acciai strutturali

Gli acciai disponibili, secondo le norme europee, americane e giapponesi, sono illustrati nelle tavole 2,3 (EN), 10 (ASTM) e 11 (JIS). Queste tavole riassuntive mostrano i requisiti principali richiesti dalla normativa circa le caratteristiche meccaniche e la composizione chimica delle qualità di acciaio.

Altre qualità (per esempio secondo lo standard CSA canadese) sono disponibili a richiesta.

La tavola 12 mostra una lista di designazioni corrispondenti fra le norme europee ed i tipi HSTAR®, con gli standard americani, canadesi, giapponesi e i vecchi standard nazionali europei.

Gli acciai vengono normalmente forniti con un contenuto di Si compreso tra 0,14% e 0,25% e pertanto sono in grado di formare uno strato di zinco durante il processo di zincatura a caldo per immersione (diagramma 1). Dato che il contenuto di fosforo in questi acciai è normalmente inferiore a 0,035%, esso non influirà minimamente sullo spessore finale del rivestimento.

Le caratteristiche meccaniche dei Profili ArcelorMittal sono ottimizzate grazie a un controllo preciso della temperatura durante il processo di laminazione. Gli acciai prodotti tramite laminazione termomeccanica (condizioni di fornitura M), se confrontati con gli acciai normalizzati, evidenziano migliori valori di resilienza grazie a bassi valori di carbonio equivalente ed a una microstruttura di grano fine. Per quanto riguarda le loro

mediante la denominada laminación termomecánica (estado de suministro M) se caracterizan por presentar mejores valores de resiliencia gracias a un menor contenido de carbono equivalente y a una microestructura de grano fino. En lo que se refiere a sus propiedades técnicas, los aceros con un tratamiento termomecánico presentan buenas características de conformado en frío. Como para los aceros estructurales convencionales, pueden ser enderezados a la llama, siempre que se tenga cuidado en no superar los límites de las temperaturas máximas. En el caso en que se considere una eliminación de tensiones para reducir las tensiones residuales, se respetarán los parámetros usuales relativos a los límites de temperatura y el tiempo de calentado conforme a las recomendaciones habituales. El conformado en caliente, que es poco corriente en la fabricación de perfiles, no debe aplicarse según la norma EN 10025:2004.

good cold forming properties. Similar to conventional structural steels, they can be flame straightened, provided specific maximum temperatures are not exceeded. In case stress relieving is considered for reducing residual stresses, the usual parameters concerning temperature range and heating time according to the rules of practice must be applied. Hot forming, which is anyway uncommon for the fabrication of sections, must not be performed in accordance with EN 10025:2004.

caratteristiche tecniche, gli acciai laminati a caldo hanno buone caratteristiche di formatura a freddo. Similmente agli acciai strutturali normali, possono essere raddrizzati a fiamma sempre che le specifiche massime di temperatura non vengano superate. Nel caso si vogliano ridurre le tensioni residue, si devono tenere presenti gli usuali range di temperatura e tempi di riscaldamento, secondo le raccomandazioni abituali. La formatura a caldo, insolita nella produzione di profilati, non deve essere applicata in osservanza della norma EN 10025:2004.

Espesor del recubrimiento de zinc en función de distintos parámetros
Thickness of the zinc coating depending on different parameters
Spessore del rivestimento di zinco in funzione di diversi parametri



Diagrama 1 / Diagram 1/ Diagramma 1

Grados y calidades de acero (continúa)

Steel grades and qualities (continued)

Qualità e caratteristiche degli acciai (continua)

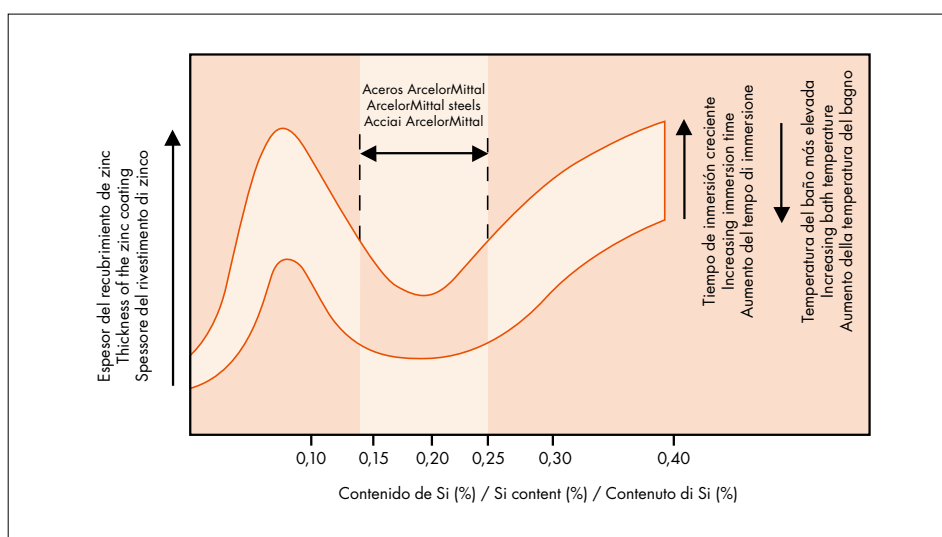
Aceros HISTAR® y FRITENAR® - Marcas registradas

General

Los aceros con marcas registradas HISTAR® y FRITENAR® no sólo cumplen totalmente la normativa aplicable a los aceros estructurales, sino que superan los requisitos de dichas normas a la vez que ofrecen garantías adicionales.

Aceros de alta resistencia con soldabilidad mejorada

HISTAR® y FRITENAR® son calidades de acero estructural de baja aleación en las que se combinan alta resistencia, buena ductilidad y excelente soldabilidad. Los aceros HISTAR® están disponibles con unos valores del límite elástico comprendidos entre 355 MPa y 460 MPa, mientras que en el caso de la calidad FRITENAR® este valor es de 355 MPa.

A diferencia de lo que se encuentra en la mayoría de las calidades convencionales de construcción, la aplicación en línea del innovador tratamiento térmico QST (Temple y Auto-Revenido) permite garantizar, para todas las calidades HISTAR®, unos valores del límite elástico mejorados en toda su gama de productos.

HISTAR® and FRITENAR® trademark steels

General

The HISTAR® and FRITENAR® trademark steels meet all requirements of the applicable structural steel standards. They exceed the requirements and offer supplementary guarantees.

High strength steels with improved weldability

HISTAR® and FRITENAR® are structural steel grades with a low alloy content, combining high strength, good toughness and superior weldability. HISTAR® steels are available in yield strengths of 355 MPa and 460 MPa, FRITENAR® steels are available in 355 MPa.

The application of the innovative in-line heat treatment QST (Quenching and Self-Tempering) allows all HISTAR® grades, unlike most standard grades, to offer improved guaranteed values for yield strength over the whole product range.

Acciai con marchio di fabbrica HISTAR® e FRITENAR®

Descrizione

Gli acciai di marchio HISTAR® e FRITENAR® rispondono, punto per punto, a tutti gli standard applicativi degli acciai strutturali. Vanno ben oltre queste richieste e offrono garanzie supplementari.

Acciai ad alta resistenza con saldabilità migliorata.

Gli acciai HISTAR® e FRITENAR® hanno un basso contenuto di leganti che permette di combinare resistenza, buona tenacità e saldabilità migliorata. Gli acciai HISTAR® sono disponibili con un limite elastico di 355 MPa e 460 MPa, gli acciai FRITENAR® sono disponibili con 355 MPa.

L'applicazione del nuovo trattamento termico innovativo "in-line" QST (Quenching and Self-Tempering = bonifica e autorivenimento) consente, diversamente dalle qualità standard, di sfruttare per tutti i tipi di HISTAR® dei valori garantiti migliorati dei limiti di snervamento su tutta la gamma dei prodotti.

Variación del límite de elasticidad mínimo con el espesor del material
Minimum yield strength according to material thickness
Snervamento minimo secondo lo spessore del materiale



Diagrama 2 / Diagram 2 / Diagramma 2

El diagrama 2 incluye una comparativa entre los límites elásticos de las calidades HISTAR® y de distintas calidades convencionales. Los aceros HISTAR® se entregan en el estado de laminación termomecánica definido en la norma EN 10025-4: 2004.

La tabla 6 recoge las características de las calidades de aceros de marcas HISTAR® y FRITENAR® disponibles. Es posible disponer de información más detallada sobre estos qualitàs de acero previa solicitud.

En términos generales, el acero suministrado tiene un contenido de silicio (Si) que oscila entre 0,14% y 0,25%, por lo que tiene la capacidad para formar una capa de zinc durante la galvanización por inmersión en baño caliente (diagrama 1). Dado que el contenido en fósforo de estos aceros es inferior normalmente al 0,035%, no ejerce ninguna influencia sobre el espesor final del recubrimiento en la franja de Si considerada.

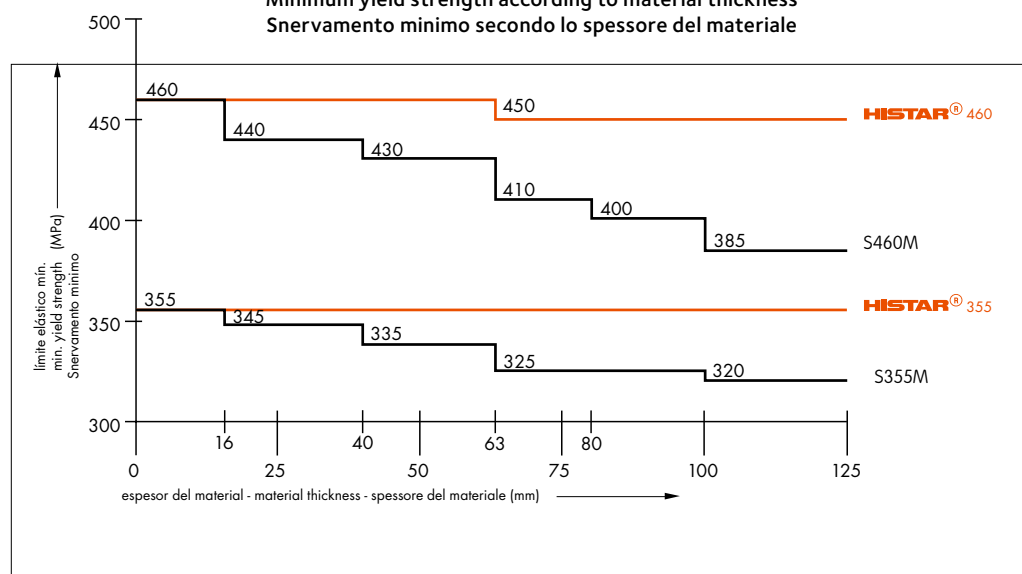
Todos los perfiles están disponibles en la calidad FRITENAR® previa solicitud y acuerdo, mientras que en calidad HISTAR®, sólo están disponibles los perfiles marcados HI (págs. 20 a 109).

Los aceros HISTAR® y FRITENAR® pueden ser sometidos a oxicrote y mecanizados mediante el proceso que se aplique normalmente a los aceros con los mismos valores de resistencia. Normalmente, gracias a su bajo nivel de carbono equivalente, en aquellos productos cuya temperatura sea $>0^{\circ}\text{C}$ no es necesario realizar un calentamiento previo para prevenir la aparición de grietas.

Los aceros HISTAR® y FRITENAR® ofrecen una excelente soldabilidad tanto en procesos automáticos como manuales siempre que se respeten las normas generales de soldadura. Debido al bajo nivel de carbono equivalente de estos aceros, y siempre que se utilicen electrodos con bajo contenido de hidrógeno, no es necesario realizar un calentamiento previo cuando el aporte térmico se sitúe en la franja 10-60 kJ/cm y las temperaturas de la estructura sean superiores a 0°C . En estas condiciones, es posible soldar toda la gama de espesores de los aceros HISTAR® 355 y FRITENAR® 355 sin recurrir al precalentamiento. Al igual que para los aceros estructurales convencionales, cuando la temperatura ambiente sea inferior a 5°C o la superficie de la pieza esté húmeda, también es recomendable secar el material antes de proceder a su soldadura.

A comparison between the yield strengths of HISTAR® grades and conventional grades is shown in diagram 2. HISTAR® steels are delivered in a thermomechanically rolled condition as defined in EN 10025-4: 2004.

Table 6 shows the characteristics of the available HISTAR® and FRITENAR® trademark steel grades. Detailed data of these steels are available upon request.

The steels are typically delivered with a Si content ranging between 0,14% and 0,25%, and are as such capable of forming a zinc layer during hot-dip galvanisation (diagram 1). As the phosphorus content of these steels is usually lower than 0,035%, it does not have any influence on the final thickness of the coating in the considered Si range.

The sections are available in the FRITENAR® grade upon agreement. For HISTAR® grades, only the sizes marked HI are available (pages 20 to 109).

HISTAR® and FRITENAR® steels can be cut with a torch and machined using the process normally applied to structural steel of the same level of strength. Due to the low carbon equivalent, preheating in order to prevent cracking is generally not necessary for product temperatures $>0^{\circ}\text{C}$.

HISTAR® and FRITENAR® steels offer good weldability for manual and automatic processes, provided the general rules for welding are respected. Due to the low carbon equivalent values of these steels, preheating is not necessary within the range of heat inputs of 10-60 kJ/cm and for temperatures of the structure over 0°C , provided that low hydrogen consumables are used. Under these conditions, no preheating is required for welding HISTAR® 355 and FRITENAR® 355 steels over the whole thickness range. As for the usual structural steels, drying before welding is recommended for ambient temperatures below 5°C and when the surface is wet.

Un confronto tra i tipi di HISTAR® ed i tipi convenzionali è evidenziato nel diagramma 2. Gli acciai HISTAR® vengono forniti con laminazione termomeccanica come specificato nella norma EN 10025-4: 2004.

La tavola 6 mostra le caratteristiche dei tipi HISTAR® e FRITENAR® disponibili. Informazioni più particolareggiate per questi acciai sono disponibili su richiesta.

Gli acciai vengono normalmente forniti con un contenuto di Si compreso tra 0,14% e 0,25% e pertanto sono in grado di formare uno strato di zinco durante il processo di zincatura a caldo per immersione (diagramma 1). Dato che il contenuto di fosforo in questi acciai è normalmente inferiore a 0,035%, esso non influenzerà minimamente lo spessore finale del rivestimento.

Le sezioni di acciaio FRITENAR® sono disponibili previo accordo. La tipologia HISTAR® è disponibile solo per le sezioni contrassegnate con HI (pagine da 20 a 109).

Gli acciai HISTAR® e FRITENAR® possono essere ossitagliati e lavorati utilizzando i processi normalmente impiegati per gli acciai dello stesso valore di resistenza. Dato il basso livello di carbonio equivalente, non è necessario il preriscaldamento per prodotti con temperature al disopra di 0°C .

Gli acciai HISTAR® e FRITENAR® offrono buona saldabilità sia per processi manuali che automatici, sempre che ciò avvenga nel rispetto delle norme generali per la saldatura. Dati i bassi valori di carbonio equivalente di questi acciai non è necessario il preriscaldamento per apporti di calore tra 10-60kJ/cm e con temperature della struttura superiori a 0°C , sempre che si usino elettrodi a basso tenore di idrogeno. In queste condizioni non è necessario il preriscaldamento nel saldare acciai HISTAR® 355 and FRITENAR® 355 di qualunque spessore. Come per gli acciai strutturali standard, si raccomanda l'asciugatura della superficie prima della saldatura quando si lavori a temperature inferiori a 5°C o qualora le superficie siano bagnate.

Grados y calidades de acero (continúa)

Steel grades and qualities (continued)

Qualità e caratteristiche degli acciai (continua)

En caso de que sea necesario eliminar tensiones en los aceros HISTAR® y FRITENAR®, esta operación se realizará a temperaturas comprendidas entre los 530°C y 580°C. El tiempo de aplicación recomendado es de 2 minutos por cada mm de espesor, sin que sea en ningún caso inferior a 30 minutos ni superior a 90 minutos.

En caso de que sea necesario realizar un breve recalentamiento en todo el espesor de las vigas HISTAR® y FRITENAR®, conviene que las temperaturas de enderezamiento a la llama no superen los 700°C, aunque para un recalentamiento localizado en la superficie son admisibles temperaturas de hasta 900°C.

If stress relieving is required for HISTAR® and FRITENAR® steels, it is performed at temperatures between 530°C and 580°C. The recommended holding time is 2 minutes per mm product thickness, but not less than 30 minutes and not more than 90 minutes.

For a short reheating of the entire thickness of HISTAR® and FRITENAR® beams, the flame straightening temperature should not exceed 700°C. For local reheating of the surface only, a flame straightening temperature of up to 900°C is allowable.

Nel caso fosse richiesto il trattamento di distensione per gli acciai HISTAR® e FRITENAR® questo avviene a temperature tra 530°C e 580°C.

Il tempo di trattamento è di 2 minuti per mm di spessore del prodotto e comunque non inferiore a 30 minuti e non superiore a 90 minuti.

Per un riscaldamento breve su tutto lo spessore dei prodotti HISTAR® e FRITENAR®, la temperatura di raddrizzamento a fiamma non deve superare i 700°C. Per un riscaldamento localizzato della sola superficie, la temperatura di raddrizzamento permessa è fino ai 900°C.

Calidades de acero para aplicaciones offshore

HISTAR® Offshore y FRITENAR® Offshore son calidades de acero estructural desarrolladas especialmente para aplicaciones offshore. Comparados con los aceros de marcas HISTAR® y FRITENAR® estas calidades offshore presentan las siguientes características adicionales:

- propiedades de deformación mejoradas en el sentido del espesor con respecto a la resistencia al desgarro laminar (calidades Z);
- propiedades de resiliencia garantizadas en sentido transversal;
- relación máxima entre límite elástico y resistencia a la tracción.

En las tablas 7 y 8 se relacionan las calidades disponibles, las características mecánicas y la composición química de estos aceros.

Steel grades for offshore applications

HISTAR® Offshore and FRITENAR® Offshore are structural steel grades especially developed for offshore applications. In comparison with HISTAR® and FRITENAR® trademark steels, the grades for offshore applications offer the following additional features:

- improved through-thickness deformation properties with respect to the resistance to lamellar tearing (Z qualities);
- notch impact properties in the transverse direction;
- maximum ratio between yield strength and tensile strength.

The available grades, their mechanical characteristics and chemical composition are shown in tables 7 and 8. The summary table 7 shows the main requirements of

Acciai per strutture marine

Gli acciai HISTAR® Offshore e FRITENAR® Offshore sono acciai strutturali sviluppati espressamente per strutture marine. Rispetto agli acciai di marca HISTAR® e FRITENAR® quelli per applicazioni offshore offrono le seguenti caratteristiche aggiuntive:

- qualità migliori di deformazione, nel senso dello spessore, in rispetto della resistenza alla lacerazione lamellare, o sfogliatura (qualità Z)
- proprietà di resiliencia in direzione trasversale
- massimo rapporto tra snervamento e resistenza alla trazione.

Le qualità disponibili, le loro caratteristiche meccaniche e la loro composizione chimica sono evidenziate nelle tavole 7 e 8. La tavola

La tabla resumen 7 presenta los requisitos principales de la norma EN 10225: 2001 en lo que respecta las características mecánicas y la composición química de las distintas calidades.

Las calidades HISTAR® y FRITENAR® Offshore que aparecen en la tabla 8 son conformes a la norma EN 10225: 2001.

Previa solicitud se podrá obtener información técnica más detallada sobre los aceros HISTAR® Offshore y FRITENAR® Offshore.

EN 10225: 2001 regarding the mechanical characteristics and the chemical composition of the steel grades.

The HISTAR® and FRITENAR® Offshore grades in Table 8 are in compliance with EN 10225:2001.

Detailed data on the HISTAR® Offshore and FRITENAR® Offshore steels are available upon request.

riassuntiva 7 mostra i requisiti richiesti dalla normativa EN10225: 2001 riguardo le caratteristiche meccaniche e la composizione chimica di questi tipi di acciaio.

I tipi di acciaio HISTAR® e FRITENAR® Offshore illustrati nella tavola 8 sono in conformità a EN 10225: 2001.

Informazioni tecniche più dettagliate per HISTAR® Offshore e FRITENAR® Offshore sono disponibili su richiesta.

Calidades Especiales de Acero

1. Aceros autopatinables según norma EN 10025-5: 2004 (tabla 9) – condiciones de suministro previa solicitud.
2. Previa solicitud, es posible suministrar calidades de acero según las normas EN 10025-2: 2004 y EN 10025-4: 2004 con características de deformación mejoradas en el sentido del espesor en lo que respecta a la resistencia al desgarro laminar (calidades Z).
3. Las calidades de acero que respetan unas especificaciones particulares (composición química y propiedades mecánicas) son objeto de un acuerdo previo, y están sujetas a un tonelaje mínimo por pedido.

Special Steel Qualities

1. Weathering steels in accordance with EN 10025-5: 2004 (table 9) – delivery conditions upon request.
2. Steel grades in accordance with EN 10025-2: 2004 and EN 10025-4: 2004 are available upon request with improved through-thickness deformation properties with respect to the resistance to lamellar tearing (Z qualities).
3. Steel grades according to particular specifications (chemical composition and mechanical properties) are subject to prior approval and minimum tonnages to be agreed upon.

Qualità speciali per gli acciai

1. Acciai resistenti alla corrosione atmosferica in conformità con la normativa EN 10025-5: 2004 (tavola 9) – condizione di fornitura su richiesta.
2. Tipi di acciaio conformi agli standard EN 10025-2: 2004 e EN 10025-4: 2004 sono disponibili su richiesta con proprietà di deformazione migliorata nel senso dello spessore relativamente alla resistenza alla lacerazione lamellare o sfogliatura (qualità Z).
3. Qualità di acciai conformi a specifiche particolari (composizione chimica e proprietà meccaniche) sono soggetti ad accordo preventivo e quantitativi minimi di fornitura.

Tabla 1 Designaciones habituales de las calidades de acero estructural

conforme a EN 10027-1: 2005, EN 10025-2: 2004, EN 10025-4: 2004

Table 1 Usual structural steel grade designations

according to EN 10027-1: 2005, EN 10025-2: 2004, EN 10025-4: 2004

Tavola 1 Designazioni tipiche degli acciai strutturali

in conformità a EN 10027-1: 2005, EN 10025-2: 2004, E 10025-4: 2004



Tabla 2

Aceros estructurales no aleados según norma europea

Table 2

Non-alloy structural steels according to European standard

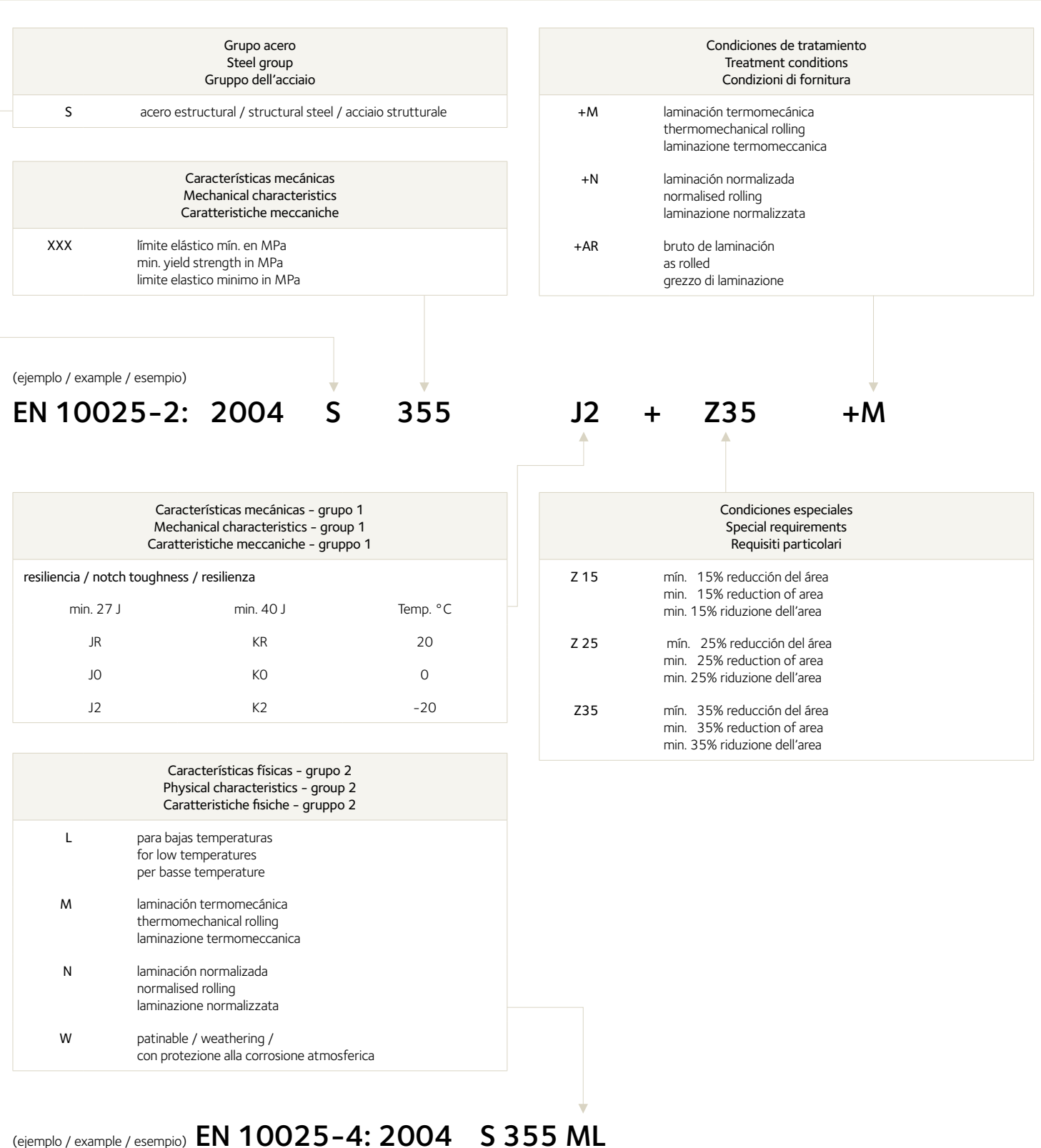
Tavola 2

Acciai strutturali non legati in conformità alle norme europee

Propiedades mecánicas / Mechanical properties / Caratteristiche meccaniche

Norma Standard Norma	Calidades Grades Tipi	Límite elástico mínimo R_{eH} Minimum yield strength R_{eH} Limite elastico minimo R_{eH}						Resistencia a la tracción R_m Tensile strength R_m Resistenza alla trazione R_m		Alargamiento mínimo A Minimum elongation A Allungamento minimo A $L_0 = 5,65 \cdot \sqrt{S_0}$ %				Ensayo de flexión por choque Notch impact test Prova di resilienza	
		MPa						MPa						Temperatura Temperature Temperatura	Energía mín. absorbida Min. absorbed energy Energia min. assorbita
		Espesor nominal (mm) Nominal thickness (mm) Spessore nominale (mm)						Espesor nominal (mm) Nominal thickness (mm) Spessore nominale (mm)		Espesor nominal (mm) Nominal thickness (mm) Spessore nominale (mm)				°C	J
		≤16	>16 ≤40	>40 ≤63	>63 ≤80	>80 ≤100	>100 ≤125	>3 ≤100	>100 ≤125	>3 ≤40	>40 ≤63	>63 ≤100	>100 ≤125		
EN 10025-2: 2004	S235JR S235J0 S235J2*	235	225	215			195	360-510	350-500	26	25	24	22	+20 0 -20	27 27 27
	S275JR S275J0 S275J2*	275	265	255	245	235	225	410-560	400-540	23	22	21	19	+20 0 -20	27 27 27
	S355JR S355J0 S355J2 S355K2	355	345	335	325	315	295	470-630	450-600	22	21	20	18	+20 0 -20 -20	27 27 27 40
	S450J0	450	430	410	390	380	380	550-720	530-700	17				0	27
	E295*	295	285	275	265	255	245	470-610	450-610	20	19	18	16		
	E335*	335	325	315	305	295	275	570-710	550-710	16	15	14	12		
E360*	360	355	345	335	325	305	670-830	650-830	11	10	9	8			

* Disponibile previo acuerdo.

* Available upon agreement.

* Disponibile previo accordo.

Tabla 2

Aceros estructurales no aleados según norma europea (continúa)

Table 2

Non-alloy structural steels according to European standard (continued)

Tavola 2

Acciai strutturali non legati in conformità alle norme europee (continua)

Composición química / Chemical composition / Composizione chimica

Norma Standard Norma	Calidades Grades Tipi	Análisis de colada Ladle analysis Analisi di colata											CEV ⁴⁾ max. %			
		C max. %			Mn max. %	Si ⁶⁾ max. %	P max. %	S max. %	N ²⁾ max. %	Cu max. %	Otros Other Altri max. %	Espesor nominal (mm) Nominal thickness (mm) Spessore nominale (mm)				
		≤ 16	>16 ≤40	>40 ³⁾								≤30	>30 ≤40	>40 ≤125		
EN 10025-2: 2004	S235JR	0,17	0,17	0,20	1,40	-	0,040 ⁶⁾	0,040	0,012	0,55	-	0,35	0,35	0,38		
	S235J0	0,17	0,17	0,17	1,40	-	0,035	0,035	0,012	0,55	-	0,35	0,35	0,38		
	S235J2*	0,17	0,17	0,17	1,40	-	0,030	0,030	-	0,55	-	0,35	0,35	0,38		
	S275JR	0,21	0,21	0,22	1,50	-	0,040 ⁶⁾	0,040	0,012	0,55	-	0,40	0,40	0,42		
	S275J0	0,18	0,18	0,18	1,50	-	0,035	0,035	0,012	0,55	-	0,40	0,40	0,42		
	S275J2*	0,18	0,18	0,18	1,50	-	0,030	0,030	-	0,55	-	0,40	0,40	0,42		
	S355JR	0,24	0,24	0,24	1,60	0,55	0,040 ⁶⁾	0,040	0,012	0,55	-	0,45	0,47	0,47		
	S355J0	0,20	0,20 ¹⁾	0,22	1,60	0,55	0,035	0,035	0,012	0,55	-	0,45	0,47	0,47		
	S355J2 ⁵⁾	0,20	0,20 ¹⁾	0,22	1,60	0,55	0,030	0,030	-	0,55	-	0,45	0,47	0,47		
	S355K2 ⁵⁾	0,20	0,20 ¹⁾	0,22	1,60	0,55	0,030	0,030	-	0,55	-	0,45	0,47	0,47		
	S450J0	0,20	0,20 ¹⁾	0,22	1,70	0,55	0,035	0,035	0,025	0,55	7)	0,47	0,49	0,49		
	E295*							0,045	0,045	0,012						
	E335*							0,045	0,045	0,012						
	E360*							0,045	0,045	0,012						

¹⁾ Para espesores nominales >30 mm: C = 0,22% máx.
²⁾ El valor máx. exigido para el nitrógeno no se aplica cuando la composición química presenta un contenido mínimo de Al total del 0,020% o cuando existe una cantidad suficiente de otros elementos que fijan el N. Los elementos que fijan el nitrógeno deben estar mencionados en el documento de control.
³⁾ Para espesores nominales >100 mm: contenido de C según acuerdo.
⁴⁾ CEV = C + Mn/6 + (Cr+Mo+V)/5 + (Cu+Ni)/15; véase § 7.2.5 de la norma EN 10025-2:2004 relativa a las condiciones especiales para S275 y S355.
⁵⁾ Acero totalmente calmado con presencia de elementos que fijan el nitrógeno en cantidades suficientes para fijar el nitrógeno presente (por ejemplo mín. 0,02 % Al). En caso de utilizar otros elementos estos deberán mencionarse en el documento de control.
⁶⁾ Previo acuerdo: Si = 0,14-0,25% y P ≤ 0,035% máx. para la capacidad de formar una capa de zinc durante la galvanización por inmersión en baño caliente (clase 3).
⁷⁾ Si se añaden más elementos, deberán ser consignados en el documento de control. Los contenidos máximos que puede presentar el acero son 0,05% de Nb, 0,13% de V y 0,05% de Ti.
¹⁾ For nominal thickness >30 mm: C = 0,22% max.
²⁾ The max. value for nitrogen does not apply if the chemical composition shows a minimum total Al content of 0,020% or if sufficient other N binding elements are present. The N binding elements shall be mentioned in the inspection document.
³⁾ For nominal thickness >100 mm: C content upon agreement.
⁴⁾ CEV = C + Mn/6 + (Cr+Mo+V)/5 + (Cu+Ni)/15; see § 7.2.5 of EN 10025-2:2004 concerning special requirements for S275 and S355.
⁵⁾ Fully killed steel containing nitrogen binding element in amounts sufficient to bind the available nitrogen (for example min. 0,02% Al). If other elements are used they shall be reported in the inspection document.
⁶⁾ Upon agreement: Si = 0,14-0,25% and P ≤ 0,035% max. for capability of forming a zinc layer during hot-dip galvanisation (class 3).
⁷⁾ If other elements are added, they shall be mentioned on the inspection document. The steel may show a Nb content of max. 0,05%, a V content of max. 0,13% and a Ti content of max. 0,05%.
¹⁾ Per spessori nominali > 30mm: C = 0,22% max.
²⁾ Il valore massimo per l'azoto non si applica nel caso la composizione chimica evidenzi il contenuto minimo totale di Al pari a 0,02% oppure siano sufficienti altri elementi leganti N. Gli elementi leganti N verranno riportati nel verbale di ispezione.
³⁾ Per spessori nominali > 100mm: Contenuto di C da concordare.
⁴⁾ CEV = C + Mn/6 + (Cr+Mo+V)/5 + (Cu+Ni)/15; vedere § 7.2.5 della norma EN 10025-2: 2004 relativa ai requisiti speciali di S275 e S355.
⁵⁾ Acciaio completamente calmato contenente elemento legante l'azoto in quantità sufficienti da legare l'azoto disponibile (per es. AL min. 0,02% Al). Nel caso venissero usati altri elementi, essi saranno riportati nel certificato di ispezione.
⁶⁾ Da concordare: Si = 0,14-0,25% e P ≤ 0,035% massimo per la capacità di formare uno strato di zinco durante la zincatura a caldo per immersione (classe 3).
⁷⁾ Nel caso venissero usati altri elementi saranno riportati nel certificato di ispezione. L'acciaio può presentare un tenore massimo di Nb dello 0,05%, un tenore massimo di V dello 0,13%, un tenore massimo di Ti dello 0,05%.

* Disponible previo acuerdo.
 * Available upon agreement.
 * Disponibile previo accordo.

Tabla 3

Aceros estructurales soldables de grano fino según norma europea

Table 3

Weldable fine grain structural steels according to European standard

Tavola 3

Acciai strutturali a grano fine saldabili in conformità alle norme europee

Propiedades mecánicas / Mechanical properties / Caratteristiche meccaniche

Norma Standard Norma	Calidades Grades Tipi	Límite elástico mínimo R_{eH} Minimum yield strength R_{eH} Limite elastico minimo R_{eH}						Resistencia a la tracción R_m Tensile strength R_m Resistenza allo snervamento R_m					Alargamiento mínimo A Minimum elonga- tion A Allungamento minimo A $L_0 = 5,65 \cdot \sqrt{S_0}$ %	Ensayo de flexión por choque Notch impact test Prova di resilienza	
		MPa						MPa						Temp. Temp. Temp	Energía mín. absorbida Min. absorbed energy Energia assorbita min.
		Espesor nominal (mm) Nominal thickness (mm) Spessore nominale (mm)						Espesor nominal (mm) Nominal thickness (mm) Spessore nominale (mm)					°C	J	
		≤16	>16 ≤40	>40 ≤63	>63 ≤80	>80 ≤100	>100 ≤125	≤40	>40 ≤63	>63 ≤80	>80 ≤100	>100 ≤125			
EN 10025-4: 2004	S275M*	275	265	255	245	245	240	370-530	360-520	350-510	350-510	350-510	24	-20	40
	S355M	355	345	335	325	325	320	470-630	450-610	440-600	440-600	430-590	22	-20	40
	S355ML	355	345	335	-	-	-	470-630	450-610	-	-	-		-50	27
	S460M	460	440	430	410	400	385	540-720	530-710	510-690	500-680	490-660	17	-20	40
	S460ML	460	440	430	-	-	-	540-720	530-710	-	-	-		-50	27

* Disponible previo acuerdo.
* Available upon agreement.
* Disponibile previo accordo.

Tabla 3

Aceros estructurales soldables de grano fino según norma europea (continúa)

Table 3

Weldable fine grain structural steels according to European standard (continued)

Tavola 3

Acciai strutturali a grano fine saldabili in conformità alle norme europee (continua)

Composición química / Chemical composition / Composizione chimica

Norma Standard Norma	Calidades Grades Tipi	Análisis de colada Ladle analysis Analisi di colata														CEV ²⁾ max. %				
		C max. %	Mn max. %	Si ³⁾ max. %	P max. %	S max. %	Al total ¹⁾ %	Nb max. %	V max. %	Ti max. %	Cr max. %	Mo max. % ²⁾	Ni max. %	Cu max. %	N max. %	Espesor nominal (mm) Nominal thickness (mm) Spessore nominale (mm)				
																	≤16	>16 ≤40	>40 ≤63	>63 ≤125
EN 10025-4: 2004	S275M*	0,15	1,50	0,50	0,030	0,025	0,02	0,05	0,08	0,05	0,30	0,10	0,30	0,55	0,015	0,34	0,34	0,35	0,38	
	S355M	0,16	1,60	0,50	0,035	0,030	0,02	0,05	0,10	0,05	0,30	0,10	0,50	0,55	0,015	0,39	0,39	0,40	0,45	
	S355ML	0,16	1,60	0,50	0,030	0,025	0,02	0,05	0,10	0,05	0,30	0,10	0,50	0,55	0,015	0,39	0,39	0,40	0,45	
	S460M	0,18	1,70	0,60	0,035	0,030	0,02	0,05	0,12	0,05	0,30	0,20	0,80	0,55	0,025	0,45	0,46	0,47	0,48	
	S460ML	0,18	1,70	0,60	0,030	0,025	0,02	0,05	0,12	0,05	0,30	0,20	0,80	0,55	0,025	0,45	0,46	0,47	0,48	

¹⁾ Cuando estén presentes elementos que fijan el nitrógeno en cantidad suficiente, el requisito de contenido mínimo de aluminio no es aplicable.

²⁾ CEV = C + Mn/6 + (Cr+Mo+V)/5 + (Cu+Ni)/15; véase § 7.2.4 de la norma EN 10025-2:2004 relativa a las condiciones especiales para S275 y S355.

³⁾ Previo acuerdo: Si = 0,14-0,25% y P ≤ 0,035% máx. para la capacidad de formar una capa de zinc durante la galvanización por inmersión en baño caliente (clase 3).

¹⁾ If sufficient nitrogen binding elements are present, the minimum aluminium requirement does not apply.

²⁾ CEV = C + Mn/6 + (Cr+Mo+V)/5 + (Cu+Ni)/15; see § 7.2.4 of EN 10025-2:2004 concerning special requirements for S275 and S355.

³⁾ Upon agreement: Si = 0,14-0,25% and P ≤ 0,035% max. for capability of forming a zinc layer during hot-dip galvanisation (class 3).

¹⁾ Se sono presenti sufficienti elementi leganti l'azoto il requisito di contenuto minimo di alluminio non si applica.

²⁾ CEV = C + Mn/6 + (Cr+Mo+V)/5 + (Cu+Ni)/15; vedere § 7.2.4 della norma EN 10025-2:2004 relativa ai requisiti speciali di S275 e S355.

³⁾ Da concordare: Si = 0,14-0,25% e P ≤ 0,035% massimo per la capacità di formare uno strato di zinco durante la zincatura a caldo per immersione (classe 3).

* Disponible previo acuerdo.

* Available upon agreement.

* Disponibile previo accordo.

Nota: los perfiles marcados ✓ en la columna EN 10025-4: 2004 están disponibles en la calidad S355 M. Otras calidades previo acuerdo.

Note: the sections marked ✓ in the EN 10025-4: 2004 column are available in grade S355 M. Other grades upon agreement.

Nota: I Profili annotati ✓ nella colonna EN 10025-4: 2004 sono disponibili nella qualità S355M. Altre qualità disponibili su richiesta.

Tabla 4

Aceros para temple y revenido - aceros no aleados de alta calidad y aceros especiales no aleados

Table 4

Steels for quenching and tempering - non-alloy quality steels and non-alloy special steels

Tavola 4

Acciai da bonifica e tempra - acciai non legati e acciai speciali non legati

Propiedades mecánicas / Mechanical properties / Caratteristiche meccaniche

Norma Standard Norma	Calidades Grades Tipi	Límite elástico mínimo R _{eH} Minimum yield strength R _{eH} Limite elastico minimo R _{eH}			Resistencia a la tracción R _m Tensile strength R _m Resistenza alla trazione R _m			Alargamiento mínimo Minimum elongation Allungamento minimo			Reducción de la sección en fractura, Z Reduction in cross section on fracture, Z Riduzione della sezione a frattura, Z			Ensayo de flexión por choque, KV Notch impact test, KV Prova di resilienza, KV J		
		MPa			MPa			L ₀ = 5,65 * √S ₀ %								
		Espesor (t) o diámetro (d) nominal (mm) Nominal thickness (t) or diameter (d) (mm) Spessore (t) o Diametro (d) nominale (mm)			Espesor (t) o diámetro (d) nominal (mm) Nominal thickness (t) or diameter (d) (mm) Spessore (t) o Diametro nominale (d) (mm)			Espesor (t) o diámetro (d) nominal (mm) Nominal thickness (t) or diameter (d) (mm) Spessore (t) o Diametro nominale (d) (mm)			Espesor (t) o diámetro (d) nominal (mm) Nominal thickness (t) or diameter (d) (mm) Spessore (t) o Diametro nominale (d) (mm)			Espesor (t) o diámetro (d) nominal (mm) Nominal thickness (t) or diameter (d) (mm) Spessore (t) o Diametro nominale (d) (mm)		
		t ≤ 8 d ≤ 16	8 < t ≤ 20 16 < d ≤ 40	20 < t ≤ 60 40 < d ≤ 100	t ≤ 8 d ≤ 16	8 < t ≤ 20 16 < d ≤ 40	20 < t ≤ 60 40 < d ≤ 100	t ≤ 8 d ≤ 16	8 < t ≤ 20 16 < d ≤ 40	20 < t ≤ 60 40 < d ≤ 100	t ≤ 8 d ≤ 16	8 < t ≤ 20 16 < d ≤ 40	20 < t ≤ 60 40 < d ≤ 100	t ≤ 8 d ≤ 16	8 < t ≤ 20 16 < d ≤ 40	20 < t ≤ 60 40 < d ≤ 100

EN 10083-2: 2006	acero alta calidad quality steel acciaio di qualità	C35	430	380	320	630 - 780	600 - 750	550 - 700	17	19	20	40	45	50	-	-	-
		C45	490	430	370	700 - 850	650 - 800	630 - 780	14	16	17	35	40	45	-	-	-
		C55	550	490	420	800 - 950	750 - 900	700 - 850	12	14	15	30	35	40	-	-	-
		C60	580	520	450	850 - 1000	800 - 950	750 - 900	11	13	14	25	30	35	-	-	-
	acero especial special steel acciaio speciale	C35E	430	380	320	630 - 780	600 - 750	550 - 700	17	19	20	40	45	50	-	35	35
		C35R	430	380	320	630 - 780	600 - 750	550 - 700	17	19	20	40	45	50	-	35	35
		C45E	490	430	370	700 - 850	650 - 800	630 - 780	14	16	17	35	40	45	-	25	25
		C45R	490	430	370	700 - 850	650 - 800	630 - 780	14	16	17	35	40	45	-	25	25
		C55E	550	490	420	800 - 950	750 - 900	700 - 850	12	14	15	30	35	40	-	-	-
		C55R	550	490	420	800 - 950	750 - 900	700 - 850	12	14	15	30	35	40	-	-	-
		C60E	580	520	450	850 - 1000	800 - 950	750 - 900	11	13	14	25	30	35	-	-	-
		C60R	580	520	450	850 - 1000	800 - 950	750 - 900	11	13	14	25	30	35	-	-	-

¹⁾ Criterios suplementarios según acuerdo.
¹⁾ Additional requirements upon agreement.
¹⁾ Requisiti addizionali da concordare

Tabla 4 (continúa)

Aceros para temple y revenido - aceros no aleados de alta calidad y aceros especiales no aleados

Table 4 (continued)

Steels for quenching and tempering - non-alloy quality steels and non-alloy special steels

Tavola 4 (continua)

Acciai da bonifica e tempra - acciai non legati e acciai speciali non legati

Composición química / Chemical composition / Composizione chimica

Norma Standard Norma	Calidades Grades Tipi	Análisis de colada Ladle analysis Analisi di colata									
		C ¹⁾ %	Mn ¹⁾ %	Si max. %	P max. %	S ¹⁾ max./min.-max. %	Cr max. %	Mo max. %	Ni max. %	Cr+Mo+Ni ¹⁾ max. %	
EN 10083-2: 2006	acero alta calidad quality steel acciaio di qualità	C35	0,32 - 0,39	0,50 - 0,80	0,40	0,045	0,045	0,40	0,10	0,40	0,63
		C45	0,42 - 0,50	0,50 - 0,80	0,40	0,045	0,045	0,40	0,10	0,40	0,63
		C55	0,52 - 0,60	0,60 - 0,90	0,40	0,045	0,045	0,40	0,10	0,40	0,63
		C60	0,57 - 0,65	0,60 - 0,90	0,40	0,045	0,045	0,40	0,10	0,40	0,63
	acero especial special steel acciaio speciale	C35E	0,32 - 0,39	0,50 - 0,80	0,40	0,030	0,035	0,40	0,10	0,40	0,63
		C35R	0,32 - 0,39	0,50 - 0,80	0,40	0,030	0,020 - 0,040	0,40	0,10	0,40	0,63
		C45E	0,42 - 0,50	0,50 - 0,80	0,40	0,030	0,035	0,40	0,10	0,40	0,63
		C45R	0,42 - 0,50	0,50 - 0,80	0,40	0,030	0,020 - 0,040	0,40	0,10	0,40	0,63
		C55E	0,52 - 0,60	0,60 - 0,90	0,40	0,030	0,035	0,40	0,10	0,40	0,63
		C55R	0,52 - 0,60	0,60 - 0,90	0,40	0,030	0,020 - 0,040	0,40	0,10	0,40	0,63
		C60E	0,57 - 0,65	0,60 - 0,90	0,40	0,030	0,035	0,40	0,10	0,40	0,63
		C60R	0,57 - 0,65	0,60 - 0,90	0,40	0,030	0,020 - 0,040	0,40	0,10	0,40	0,63

¹⁾ Criterios suplementarios según acuerdo.
¹⁾ Additional requirements upon agreement.
¹⁾ Requisiti addizionali da concordare.

Tabla 5

Aceros para cementación - aceros especiales no aleados

Table 5

Case hardening steels - non alloy special steels

Tavola 5

Acciai da cementazione - acciai speciali non legati

Composición química / Chemical composition / Composizione chimica

Norma Standard Norma		Calidades Grades Tipi	Análisis de colada Ladle analysis Analisi di colata					Ensayo de dureza Brinell Brinell hardness in the condition Prova di durezza Brinell
			C ¹⁾ %	Mn ¹⁾ %	Si max. %	P max. %	S ¹⁾ %	+A ²⁾ max.
EN 10084: 1998	acero especial special steel acciaio speciale	C10E	0,07 - 0,13	0,30 - 0,60	0,40	0,035	≤ 0,035	131
		C10R	0,07 - 0,13	0,30 - 0,60	0,40	0,035	0,020 - 0,040	131
		C15E	0,12 - 0,18	0,30 - 0,60	0,40	0,035	≤ 0,035	143
		C15R	0,12 - 0,18	0,30 - 0,60	0,40	0,035	0,020 - 0,040	143

¹⁾ Criterios suplementarios según acuerdo.

²⁾ +A: recocido según requisito de máxima dureza.

¹⁾ Additional requirements upon agreement

²⁾ +A: annealed to maximum hardness requirements

¹⁾ Requisiti addizionali da concordare

²⁾ +A: bonificato alla durezza massima richiesta

Tabla 6

Aceros HISTAR® y FRITENAR® - Marcas registradas

Table 6

HISTAR® and FRITENAR® Trademark Steels

Tavola 6

Acciai con marchio di fabbrica HISTAR® e FRITENAR®

Propiedades mecánicas / Mechanical properties / Caratteristiche meccaniche

Calidades Grades Tipi	Límite elástico mínimo R_{eH} Minimum yield strength R_{eH} Limite elastico minimo R_{eH}				Resistencia a la tracción R_m Tensile strength R_m Resistenza alla trazione R_m	Alargamiento mínimo A Minimum elongation A Allungamento minimo A $L_0 = 5,65 \cdot \sqrt{S_0}$ %	Ensayo de flexión por choque, longitudinal ¹⁾ Notch impact test longitudinal ¹⁾ Prova di resilienza longitudinale ¹⁾		
	MPa						MPa	Temperatura Temperature Temperatura	Energía mín. absorbida Min. absorbed energy Energia min. assorbita
	Espesor nominal (mm) Nominal thickness (mm) Spessore nominale (mm)								
	≤16	>16 ≤40	>40 ≤63	>63 ≤125			°C	J	
HISTAR 355	355				470-630	22	0 -20	47 40	
HISTAR 355 L	355		-		470-630	22	-20 -50	47 27	
HISTAR 460	460		450		540-720	17	0 -20	47 40	
HISTAR 460 L	460		-		540-720	17	-20 -50	47 27	
FRITENAR 355	355	345	-	-	470-630	22	-20	41	

¹⁾ Valor medio de 3 ensayos en probetas sin reducir, sin que ninguno de sus valores sea inferior al 70% del valor medio garantizado. Son aplicables las especificaciones de la norma EN 10025-1: 2004.

¹⁾ Mean value of 3 tests for full size specimens with no single value less than 70% of the guaranteed average value. The provisions according to EN 10025-1: 2004 are applicable.

¹⁾ Valore medio di 3 prove relative a modelli in scala naturale in cui nessuna prova sarà inferiore al 70% del valore medio garantito. Sono applicabili le condizioni di conformità EN 10025-1: 2004.

Composición química / Chemical composition / Composizione chimica

Calidades Grades Tipi	Análisis de colada Ladle analysis Analisi di colata										
	C max. %	Mn max. %	Si ³⁾ max. %	P max. %	S max. %	Al ²⁾ min. %	Nb max. %	V max. %	Ti max. %	CEV ¹⁾ max. %	
										Espesor nominal (mm) Nominal thickness (mm) Spessore nominale (mm)	
										≤63	>63 ≤125
HISTAR 355	0,12	1,60	0,50	0,035	0,030	0,02	0,05	0,10	0,05	0,39	0,39
HISTAR 355 L	0,12	1,60	0,50	0,030	0,025	0,02	0,05	0,10	0,05	0,39	-
HISTAR 460	0,12	1,70	0,60	0,035	0,030	0,02	0,05	0,12	0,05	0,41	0,43
HISTAR 460 L	0,12	1,70	0,60	0,030	0,025	0,02	0,05	0,12	0,05	0,41	-
FRITENAR 355	0,14	1,60	0,55	0,030	0,030	0,02	0,05	0,06	0,05	0,40 (≤40 mm)	-

¹⁾ $CEV = C + Mn/6 + (Cr + Mo + V)/5 + (Cu + Ni)/15$.

²⁾ Cuando estén presentes elementos que fijan el nitrógeno en cantidad suficiente, el requisito de contenido mínimo de aluminio no es aplicable.

³⁾ Previo acuerdo: Si = 0,14-0,25% y P ≤ 0,035% máx. para la capacidad de formar una capa de zinc durante la galvanización por inmersión en baño caliente.

¹⁾ $CEV = C + Mn/6 + (Cr + Mo + V)/5 + (Cu + Ni)/15$.

²⁾ If sufficient nitrogen binding elements are present, the minimum aluminium requirement does not apply.

³⁾ Upon agreement: Si = 0,14-0,25% and P ≤ 0,035% max. for capability of forming a zinc layer during hot-dip galvanisation.

¹⁾ $CEV = C + Mn/6 + (Cr + Mo + V)/5 + (Cu + Ni)/15$.

²⁾ Se sono presenti sufficienti elementi leganti l'azoto il requisito di contenuto minimo di alluminio non si applica.

³⁾ Da concordare: Si = 0,14-0,25% e P ≤ 0,035% massimo per la capacità di formare uno strato di zinco durante la zincatura a caldo per immersione.

Tabla 7 Aceros estructurales soldables para estructuras offshore fijas según norma europea

Table 7 Weldable structural steels for fixed offshore structures according to European standard

Tavola 7 Acciai strutturali saldabili per strutture marine (offshore) in conformità alle norme europee

Propiedades mecánicas / Mechanical properties / Caratteristiche meccaniche

Norma Standard Norma	Calidades Grades Tipi	Límite elástico mínimo R_{eH} Minimum yield strength R_{eH} Limite elastico minimo R_{eH}			Resistencia a la tracción R_m Tensile strength R_m Resistenza alla trazione R_m	Alargamiento mínimo A Minimum elongation A Allungamento minimo A $L_0 = 5,65 \cdot \sqrt{S_0}$ %	Ensayo de flexión por choque Notch impact test Prova di resilienza	
		MPa			MPa		Temperatura Temperature Temperatura	Energía mín. absorbida Min. absorbed energy Energia min. assorbita
		Espesor nominal (mm) Nominal thickness (mm) Spessore nominale (mm)						°C
		≤16	>16 ≤40	R_e/R_m max.				
EN 10225: 2001	S355G1 ^{4)*}	355	345	0,87	470-630	22	-20	50
	S355G4+M	355	345	0,87	450-610	22	-20	50
	S355G11+M	355	345	0,87	460-620	22	-40 ²⁾	50
	S355G12+M	355	345	0,87	460-620	22	-40 ²⁾	50 ¹⁾
	S460G3+M	460	440	0,90	530-720	17	-40 ²⁾	60
	S460G4+M	460	440	0,90	530-720	17	-40 ²⁾	60 ³⁾

¹⁾ Para los perfiles de calidad S355 G12 + M los ensayos de flexión por choque Charpy con entalla en V se realizan en sentido transversal en lugar de longitudinal con el objeto de obtener un valor medio mínimo de 50J a -40°C.

²⁾ Para espesores inferiores o iguales a 25 mm el ensayo se realiza a -20°C.

³⁾ Para los perfiles de calidad S460 G4 + M los ensayos de flexión por choque Charpy con entalla en V se realizan en sentido transversal además de en sentido longitudinal. Los valores de energía y las temperaturas de los ensayos transversales deberán ser acordados entre el fabricante y el cliente en el momento de la consulta y de la formulación del pedido.

⁴⁾ Disponible únicamente en espesores inferiores a 25 mm.

¹⁾ For section grades S355 G12 + M, transverse Charpy V-notch impacts tests shall be carried out in lieu of longitudinal tests to meet 50J minimum average at -40°C.

²⁾ For up to and including 25 mm thickness, test at -20°C.

³⁾ For section grade S460 G4 + M, transverse Charpy V-notch impact tests shall be carried out in addition to longitudinal tests. Energy values and test temperatures for the transverse tests shall be agreed between manufacturer and purchaser at the time of enquiry and order.

⁴⁾ Available up to 25 mm thick only.

¹⁾ Per i tipi di Profili S355 G12 +M, verrà eseguita la prova di resilienza trasversale su provetta Charpy con intaglio a V in sostituzione ai test longitudinali, al fine di soddisfare un valore medio minimo 50J a -40°C

²⁾ Fino a spessori di 25mm inclusi, prova a -20°C.

³⁾ Per i tipi di Profili S460 G4 +M, verrà eseguita la prova di resilienza trasversale su provetta Charpy con intaglio a V in aggiunta ai test longitudinali.

I valori di energia e la temperatura dei test relativi alle prove trasversali verranno concordati tra il cliente ed il produttore al momento dell'ordine.

⁴⁾ Disponibile solo fino a 25mm di spessore.

* Disponible previo acuerdo.

* Available upon agreement.

* Disponibile previo accordo.

Nota: los perfiles marcados ✓ en la columna EN 10225: 2001 están disponibles en la calidad S355 G4+M. Otras calidades previo acuerdo.

Note: the sections marked ✓ in the EN 10225: 2001 column are available in grade S355 G4+M. Other grades upon agreement.

Nota: I Profili annotati ✓ nella colonna EN 10225: 2001 sono disponibili nella qualità S355 G4+M. Altre qualità disponibili su richiesta.

Composición química / Chemical composition / Composizione chimica

Norma Standard Norma	Calidades Grades Tipi	Análisis de colada Ladle analysis Analisi di colata														
		C max. %	Si ⁵⁾ max. %	Mn %	S max. %	P max. %	Cr max. %	Mo max. %	Ni max. %	Al (Total) ²⁾ %	Cu max. %	N max. %	Nb max. %	Ti max. %	V max. %	Cr +Mo +Ni +Cu max. %

EN 10225: 2001	Análisis de colada / ladle analysis / Analisi di colata ¹⁾																	
	S355G1 ⁴⁾ *	0,20	0,50	0,90-1,65	0,030	0,035	0,30	0,10	0,50	0,020 min.	0,35	0,015	0,050	0,030	0,120	-	-	-
	S355G4+M	0,16	0,50	1,60 max.	0,030	0,035	-	0,20	0,30	0,020 min.	0,35	0,015	0,050	0,050	0,100	-	-	-
	Análisis de colada y producto / ladle and product analysis / Analisi di colata del prodotto																	
	S355G11+M ³⁾	0,14	0,55	1,65 max.	0,015	0,025	0,25	0,08	0,50	0,015/0,055	0,30	0,012	0,040	0,025	0,060	0,80	0,06	0,08
	S355G12+M ³⁾	0,14	0,55	1,65 max.	0,007	0,020	0,25	0,08	0,50	0,015/0,055	0,30	0,012	0,040	0,025	0,060	0,80	0,06	0,08
	S460G3+M ³⁾	0,14	0,55	1,70 max.	0,015	0,025	0,25	0,08	0,70	0,015/0,055	0,30	0,012	0,050	0,025	0,080	0,80	0,12	0,13
	S460G4+M ³⁾	0,14	0,55	1,70 max.	0,007	0,020	0,25	0,08	0,70	0,015/0,055	0,30	0,012	0,050	0,025	0,080	0,80	0,12	0,13

¹⁾ Consultar la composición química de los productos en la Tabla 12 de la norma EN 10225: 2001.

²⁾ La relación aluminio/nitrógeno será, como mínimo, de 2:1. Si se utilizasen otros elementos fijadores del nitrógeno, no serán aplicables los requisitos sobre el contenido mínimo de Al y de relación Al:N.

³⁾ La presencia de elementos residuales: arsénico, antimonio, estaño, plomo, bismuto y calcio no superará los siguientes límites: As 0,030%, Sb 0,010%, Sn 0,020%, Pb y Bi 0,010% y Ca 0,005%. El contenido en boro (B) no será superior al 0,0005%. En cada instalación de producción se comprobará el contenido en estos elementos al menos cada 5000 toneladas, notificándose estos resultados como un análisis de colada.

⁴⁾ En estado bruto de laminación limitado a un espesor máximo de 25 mm.

⁵⁾ Previo acuerdo: Si = 0,14-0,25% y P ≤ 0,035% máx. para la capacidad de formar una capa de zinc durante la galvanización por inmersión en baño caliente.

¹⁾ For product chemical composition see Table 12 of EN 10225: 2001.

²⁾ The total aluminium to nitrogen ratio shall be a minimum of 2:1. When other nitrogen binding elements are used, the minimum Al value and Al:N ratio does not apply.

³⁾ The levels of the residual elements: arsenic, antimony, tin, lead, bismuth and calcium shall not exceed 0,030% As, 0,010% Sb, 0,020% Sn, 0,010% Pb, 0,010% Bi and 0,005% Ca. Boron (B) shall not exceed 0,0005%. These elements shall be checked at least once every 5000 tonnes at each manufacturing location and shall be reported as a ladle analysis.

⁴⁾ As rolled condition limited to a maximum thickness of 25 mm.

⁵⁾ Upon agreement: Si = 0,14-0,25% and P ≤ 0,035% max. for capability of forming a zinc layer during hot-dip galvanisation.

¹⁾ Per la composizione chimica vedere la tavola 12 di EN 10225: 2001.

²⁾ Il rapporto totale fra alluminio e azoto dovrà essere almeno di 2:1. Quando vengono usati altri elementi leganti l'azoto, il minimo rapporto fra Al:N non si applica.

³⁾ Il livello degli elementi residui: arsenico, antimonio, stagno, bismuto e calcio non deve essere superiore a As 0,030%, Sb 0,010%, Sn 0,020%, Pb 0,010%, Bi 0,010% e Ca 0,005%. Il boro (B) non deve superare lo 0,0005%. Questi elementi dovranno essere controllati almeno ogni 5000 tonnellate in ogni sito di produzione e dovranno essere riportati nelle analisi di colata.

⁴⁾ Grezzo di laminazione limitato ad uno spessore massimo di 25mm.

⁵⁾ da concordare: Si = 0,14-0,25% e P ≤ 0,035% max. per la capacità di formare uno strato di zinco durante la zincatura a caldo per immersione.

* Disponible previo acuerdo.

* Available upon agreement.

* Disponibile previo accordo.

Nota: los perfiles marcados ✓ en la columna EN 10225: 2001 están disponibles en la calidad S355 G4+M. Otras calidades previo acuerdo.

Note: the sections marked ✓ in the EN 10225: 2001 column are available in grade S355 G4+M. Other grades upon agreement.

Nota: I Profili annotati ✓ nella colonna EN 10225: 2001 sono disponibili nella qualità S355 G4+M. Altre qualità disponibili su richiesta.

Tabla 8

Calidades de acero HISTAR® y FRITENAR® para aplicaciones offshore

Table 8

HISTAR® and FRITENAR® steel grades for offshore applications

Tavola 8

Acciai con marchio di fabbrica HISTAR® e FRITENAR® per strutture marine (offshore)

Propiedades mecánicas / Mechanical properties / Caratteristiche meccaniche

Calidades Grades Tipi	Límite elástico mínimo R _e Minimum yield strength R _e Limite elastico min. R _e		Resistencia a la tracción R _m Tensile strength R _m Resistenza alla trazione R _m	Coeficiente máx. R _e / R _m Max. ratio R _e / R _m rapporto massimo R _e / R _m	Alargamiento mínimo A Minimum elongation A Allungamento minimo A	Reducción mín. del área. Z ₂ ¹⁾ Min reduction of area Z ₂ ¹⁾ Riduzione min. dell' area Z ₂ ¹⁾	Ensayo de flexión por choque ⁴⁾ Notch impact test ⁴⁾ Prova di resilienza ⁴⁾			
	MPa		MPa		LO=5,65* √S ₀ %	%	longitudinal longitudinale		transversal ⁵⁾ trasversale ⁵⁾	
	Espesor nominal (mm) Nominal thickness (mm) Spessore nominale (mm)						Temperatura Temperature Temperatura	Energía absorbida Absorbed energy Energia assorbita	Temperatura Temperature Temperatura	Energía absorbida Absorbed energy Energia assorbita
	≤16	>16					°C	J	°C	J

HISTAR 355 TZ OS ³⁾	355	355	460-620	0,87	22	25	-20	50	-20	27
HISTAR 355 TZK OS ²⁾³⁾	355	355	460-620	0,87	22	35	-40	50	-40	50
HISTAR 460 TZ OS ³⁾	460	460	530-720	0,90	17	25	-20	60	-20	27
HISTAR 460 TZK OS ²⁾³⁾	460	460	530-720	0,90	17	35	-40	60	-40	50
FRITENAR 355 OS	355	345	460-610	0,87	22	-	-20	50	-	-
FRITENAR 355 TZK OS ²⁾³⁾	355	345	460-620	0,87	22	35	-40	50	-40	50

¹⁾ Ensayo en sentido transversal al espesor según acuerdo. Valor medio de 3 ensayos. Solamente para t >15 mm.

²⁾ Para espesores ≤ 25 mm, ensayo con probeta Charpy en V a -20°C.

³⁾ Calidad disponible para perfiles marcados HI; consultar la disponibilidad para otros perfiles.

⁴⁾ Valor medio de 3 ensayos en probetas sin reducir, sin que ninguno de sus valores sea inferior al 70% del valor medio garantizado. Son aplicables las especificaciones de la norma EN 10225: 2001.

⁵⁾ Ensayo previo acuerdo.

¹⁾ Through thickness testing upon agreement. Mean value of 3 tests. Only for t >15 mm.

²⁾ For thickness ≤ 25 mm, Charpy V test at -20°C.

³⁾ Grade available for sections marked HI; other sections upon request.

⁴⁾ Mean value of 3 tests for full size specimens with no single value less than 70% of the guaranteed average value. The provisions according to EN 10225: 2001 are applicable.

⁵⁾ Tested upon agreement.

¹⁾ Test in spessore previo accordo. Valore medio di 3 prove. Solo per T > 15mm.

²⁾ Per spessore ≤ 25 mm, prova di resilienza Charpy con intaglio a V a -20°C.

³⁾ Disponibile per sezioni contrassegnate HI; consultare la disponibilità per altre sezioni.

⁴⁾ Valore medio di 3 prove relative a modelli in scala naturale in cui nessuna prova risulti inferiore al 70% del valore medio garantito. Sono applicabili le condizioni di conformità EN 10225: 2001.

⁵⁾ Test previo accordo.

Composición química / Chemical composition / Composizione chimica

Calidades Grades Tipi	Análisis de colada Ladle analysis Analisi di colata									
	C max. %	Mn max. %	Si ⁴⁾ max. %	P max. %	S max. %	Al ¹⁾ min. %	Nb max. %	Ti max. %	V max. %	CEV ²⁾ max. %
HISTAR 355 TZ OS ³⁾	0,12	1,60	0,30	0,025	0,010	0,02	0,04	0,025	0,06	0,38
HISTAR 355 TZK OS ³⁾	0,12	1,60	0,30	0,020	0,007	0,02	0,04	0,025	0,06	0,38
HISTAR 460 TZ OS ³⁾	0,12	1,70	0,30	0,025	0,010	0,02	0,05	0,025	0,06	0,39
HISTAR 460 TZK OS ³⁾	0,12	1,70	0,30	0,020	0,007	0,02	0,05	0,025	0,06	0,39
FRITENAR 355 OS	0,12	1,60	0,30	0,030	0,025	0,02	0,05	0,025	0,06	0,39
FRITENAR 355 TZK OS ³⁾	0,12	1,60	0,30	0,020	0,007	0,02	0,04	0,025	0,06	0,38

¹⁾ Cuando se utilizan otros elementos que fijan el nitrógeno, el requisito de contenido mínimo de aluminio no es aplicable.

²⁾ $CEV = C + Mn/6 + (Cr+Mo+V)/5 + (Cu+Ni)/15$.

³⁾ Calidad disponible para perfiles marcados HI; consultar la disponibilidad para otros perfiles.

⁴⁾ Previo acuerdo: Si = 0,14-0,25% y P ≤ 0,035% máx. para la capacidad de formar una capa de zinc durante la galvanización por inmersión en baño caliente.

¹⁾ When other N-binding elements are used, the min. Al value does not apply.

²⁾ $CEV = C + Mn/6 + (Cr + Mo + V)/5 + (Cu + Ni)/15$.

³⁾ Grade available for sections marked HI; other sections upon request.

⁴⁾ Upon agreement: Si = 0,14-0,25% and P ≤ 0,035% max. for capability of forming a zinc layer during hot-dip galvanisation.

¹⁾ Quando si usano altri elementi leganti N il valore min. di Al non si applica.

²⁾ $CEV = C + Mn/6 + (Cr + Mo + V)/5 + (Cu + Ni)/15$.

³⁾ Qualità disponibile per sezioni contrassegnate HI; consultare la disponibilità per altre sezioni.

⁴⁾ Da concordare: Si = 0,14-0,25% e P ≤ 0,035% max. per la capacità di formare uno strato di zinco durante la zincatura a caldo per immersione.

Tabla 9 Aceros estructurales con resistencia mejorada a la corrosión atmosférica según norma europea

Table 9 Structural Steels with improved atmospheric corrosion resistance according to European standard

Tavola 9 Acciai strutturali con resistenza migliorata alla corrosione atmosferica in conformità alle norme europee

Propiedades mecánicas / Mechanical properties / Caratteristiche meccaniche

Norma Standard Norma	Calidades Grades Tipi	Límite elástico mínimo R _{eh} Minimum yield strength R _{eh} Limite elastico minimo R _{eh}					Resistencia a la tracción R _m Tensile strength R _m Resistenza alla trazione R _m		Alargamiento mínimo A Minimum elongation A Allungamento minimo A LO = 5,65 * √S ₀ %		
		MPa					MPa				
		Espesor nominal (mm) Nominal thickness (mm) Spessore nominale (mm)					Espesor nominal (mm) Nominal thickness (mm) Spessore nominale (mm)		Espesor nominal (mm) Nominal thickness (mm) Spessore nominale (mm)		
		≤16	>16 ≤40	>40 ≤63	>63 ≤80	>80 ≤100	>3 ≤100	>3 ≤40	>40 ≤63	>63 ≤100	
EN 10025-5: 2004	S235J0W* S235J2W*	235	225	215	215	215	360-510	26	25	24	
	S355J0WP* S355J2WP*	355	345	-	-	-	470-630 ¹⁾	22	-	-	
	S355J0W* S355J2W* S355K2W*	355	345	335	325	315	470-630	22	21	20	

¹⁾ Aplicable hasta 40 mm
¹⁾ Applicable up to 40 mm
¹⁾ Si applica fino a 40mm.

* Disponible previo acuerdo.
 * Available upon agreement.
 * Disponibile previo accordo.

Composición química / Chemical composition / Composizione chimica

Norma Standard Norma	Calidades Grades Tipi	Análisis de colada Ladle analysis Analisi di colata									
		C max. %	Si max. %	Mn %	P %	S max. %	N max. %	Adición de e.f.n. ¹⁾ Addition of n.b.e. ¹⁾ Aggiunta di e.l.a ¹⁾	Cr max. %	Cu %	Otros Others Altri
EN 10025-5: 2004	S235J0W* S235J2W*	0,13	0,40	0,20-0,60	max. 0,040	0,040 0,035	0,009 ²⁾⁵⁾ -	- sí / yes / si	0,40-0,80	0,25-0,55	³⁾
	S355J0WP* S355J2WP*	0,12	0,75	max. 1,0	0,06-0,15	0,040 0,035	0,009 ⁵⁾ -	- sí / yes / si	0,30-1,25	0,25-0,55	³⁾
	S355J0W* S355J2W*	0,16	0,50	0,50-1,50	max. 0,040	0,040	0,009 ²⁾⁵⁾	-	0,40-0,80	0,25-0,55	³⁾⁴⁾
	max. 0,035				0,035	-	sí / yes / si				
S355K2W*				max. 0,035	0,035	-	sí / yes / si				

¹⁾ Adición de elementos fijadores de nitrógeno: los aceros deben contener al menos uno de los elementos siguientes: Al total $\geq 0,020\%$, Nb: 0,015 - 0,060%, V: 0,02-0,12%, Ti: 0,02 - 0,10%. Si estos elementos están combinados, al menos uno de ellos debe estar presente en la cantidad mínima indicada.

²⁾ Se permite superar los valores especificados siempre que por cada incremento de N del 0,001% el contenido máximo de P se reduzca en 0,005%; el contenido de N en el análisis de colada, no obstante, no podrá superar el 0,012%.

³⁾ Los aceros pueden contener como máximo un 0,65% de Ni.

⁴⁾ Los aceros pueden contener como máximo un 0,30% de Mo y un 0,15% de Zr.

⁵⁾ El valor máx. exigido para el nitrógeno no se aplica cuando la composición química presenta un contenido mínimo de Al total del 0,020% o cuando existe una cantidad suficiente de otros elementos que fijan el N. El documento de control mencionará los elementos que fijan el N.

¹⁾ Addition of nitrogen binding elements: the steels shall contain at least one of the following elements: Al total $\geq 0,020\%$, Nb: 0,015 - 0,060%, V: 0,02-0,12%, Ti: 0,02 - 0,10%. If these elements are used in combination, at least one of them shall be present with the minimum content indicated.

²⁾ It is permissible to exceed the specified values provided that for each increase of 0,001 % N, the Pmax content will be reduced by 0,005%; the N content of the ladle analysis, however, shall not be more than 0,012%.

³⁾ The steels may show a Ni content of max. 0,65%.

⁴⁾ The steels may contain max. 0,30% Mo and max. 0,15% Zr.

⁵⁾ The max. value for nitrogen does not apply if the chemical composition shows a minimum total Al content of 0,020% or if sufficient other N binding elements are present. The N binding elements shall be mentioned in the inspection document.

¹⁾ Aggiunta di elementi leganti l'azoto: gli acciai devono contenere almeno uno dei seguenti elementi: Al totale $\geq 0,020\%$, Nb: 0,015 - 0,060%, V: 0,02-0,12%, Ti: 0,02 - 0,10%. Se questi elementi sono usati in combinazione, almeno uno di loro dovrà essere presente con il contenuto minimo indicato.

²⁾ È ammesso superare i valori indicati, sempre che per ogni aumento del 0,001% di N il contenuto di Pmax venga ridotto del 0,005%; il contenuto N dell'analisi di colata non dovrà comunque superare lo 0,012%.

³⁾ Questi acciai possono presentare un tenore massimo di Nb dello 0,65%.

⁴⁾ Gli acciai possono contenere un massimo di 0,30% Mo e un massimo di 0,15% Zr.

⁵⁾ Il valore massimo per l'azoto non si applica nel caso la composizione chimica evidenzi il contenuto minimo totale di Al pari a 0,020% oppure quando siano sufficienti altri elementi leganti N. Gli elementi leganti N verranno riportati nel certificato di ispezione.

* Disponible previo acuerdo.

* Available upon agreement.

* Disponibile previo accordo.

Tabla 10

Calidades de acero según normas americanas

Table 10

Steel grades according to American standards

Tavola 10

Tipi di acciaio in conformità alle norme americane

Propiedades mecánicas / Mechanical properties / Caratteristiche meccaniche

Normas Standards Norma	Calidades Grades Tipi	Límite elástico R _e Yield strength R _e Limite elastico R _e	Resistencia a la tracción R _m Tensile strength R _m Resistenza alla trazione R _m	Ratio R _e /R _m Ratio R _e /R _m Rapporto R _e /R _m	Alargamiento mínimo A Minimum elongation A Allungamento minimo A		Ensayo de flexión por choque ³⁾ Notch impact test ³⁾ Prova di resilienza ³⁾	
					min. 200 mm [8 in.]	min. 50 mm [2 in.]	ASTM A673, standard position ala longitudinal longitudinal, flange Posizione long. flange	
		MPa [ksi]	MPa [ksi]		%	%	Temperatura Temperature Temperatura °C (°F)	Media de energía Energy average Energia media J [ft-lbf]
A36-05	Grade 36*	≥250 [36]	400-550 ²⁾ [58-80]		20 ¹⁾	21 ²⁾		
A572-07	Grade 42*	≥290 [42]	≥415 [60]		20 ¹⁾	24 ^{1)2b)}		
	Grade 50	≥345 [50]	≥450 [65]		18 ¹⁾	21 ^{1)2b)}		
	Grade 55*	≥380 [55]	≥485 [70]		17 ¹⁾	20 ^{1)2b)}		
	Grade 60*	≥415 [60]	≥520 [75]		16 ¹⁾	18 ^{1)2b)}		
	Grade 65*	≥450 [65]	≥550 [80]		15 ¹⁾	17 ^{1)2b)}		
A588-05	Grade B*	≥345 [50]	≥485 [70]		18 ¹⁾	21 ^{1)2a)}		
	Grade C*	≥345 [50]	≥485 [70]		18 ¹⁾	21 ^{1)2a)}		
A709-07	Grade 36*	≥250 [36]	400-550 ²⁾ [58-80]		20 ¹⁾	21 ¹⁾²⁾		5)
	Grade 50	≥345 [50]	≥450 [65]		18 ¹⁾	21 ¹⁾²⁾		5)
	Grade 50S	345-450 [50-65]	≥450 [65]	≤0,85	18 ¹⁾	21 ¹⁾		5)
A913-04	Grade 50	≥345 ⁴⁾ [50]	≥450 [65]	≤0,85 ⁴⁾	18	21	21 [70]	≥54 [40]
	Grade 65	≥450 [65]	≥550 [80]		15	17	21 [70]	≥54 [40]
A992-06a	Grade 50	345-450 [50-65]	≥450 [65]	≤0,85	18 ¹⁾	21 ¹⁾		

¹⁾ Véanse los ajustes relativos a los requisitos de elongación en el apartado "Ensayos de Tensión" de la norma A6 /A6M.

²⁾ Para perfiles con espesor de ala >75 mm (3 pulg.): A min. 19% en 2 pulg. (50 mm), Gr.36 exento de Rm máx.

^{2a)} Para perfiles con espesor de ala >75 mm (3 pulg.): A min. 18% en 2 pulg. (50 mm).

^{2b)} Para perfiles superiores a 634 Kg/m (426 lbs/ft): A min. 19% en 2 pulg. (50 mm).

³⁾ Previo acuerdo: requisito adicional S30 según ASTM A 6/A 6M: "CVN test, alternate core location" = "Ensayo CVN, intersección núcleo-ala, resiliencia media mín. 27J [20 ft-lbf] a 21°C. [70°F], aplicable a espesor del ala ≥ 38.1 mm [1.5 pulg.], (anteriormente AISC Sup.2 para secciones de los grupos 4 y 5 de A6).

⁴⁾ Previo acuerdo: requisito adicional S75 según ASTM A 913 / A913M: Re/Rm máx. 0.85 y Re máx. 450 MPa [65 ksi], aplicable a Calidad 50.

⁵⁾ Previo acuerdo, requisito adicional: ensayo de resiliencia conforme a la tabla de A709:07.

¹⁾ See elongation requirement adjustments under the "Tension Tests" section of standard A6 / A6M.

²⁾ For shapes with flange thickness >75 mm (3 in.): A min. 19% on 2 in. (50 mm), Gr.36 exempted of Rm max.

^{2a)} For shapes with flange thickness >75 mm (3 in.): A min. 18% on 2 in. (50 mm)

^{2b)} For shapes over 634 Kg/m (426 lbs/ft): A min. 19% on 2 in. (50 mm).

³⁾ Upon agreement: supplementary requirement S30 of ASTM A 6/A 6M: "CVN test, alternate core location" = min. ave energy 27J [20 ft-lbf] at 21 °C [70°F], applicable to flange thickness ≥ 38.1 mm [1.5 in.], (formerly AISC Sup.2 for shapes of size groups 4 and 5 of A6).

⁴⁾ Upon agreement: supplementary requirement S75 of ASTM A 913/A913M: Re/Rm max. 0.85 and Re max. 450 MPa [65 ksi], applicable to Grade 50.

⁵⁾ Supplementary requirement upon agreement: notch impact test according to table of A709:07.

¹⁾ Vedere i requisiti di allungamento nella sezione dedicata alle "Prove di tensione" per le norme ASTM A6/A6M.

²⁾ Per i Profili con spessori di ala > 75mm (3 pollici) : A min. del 19% su 2 pollici (50 mm), Gr.36 esente da Rm max.

^{2a)} Per i Profili con spessori di ala > 75mm (3 pollici) : A min. del 18% su 2 pollici (50 mm).

^{2b)} Per Profili superiori a 634 Kg/m (426 lbs/ft): A min. 19% su 2 pollici (50 mm).

³⁾ Da concordare: requisiti supplementari S30 di ASTM A 6/A 6M: Prova CVN intersezione anima-ala, resiliencia media minima 27J [20 ft-lbf] a 21 °C [70 °F] applicabile allo spessore delle ali ≥ 38.1 mm [1.5 pollici], (precedenti norme AISC Sup.2 per Profili appartenenti ai gruppi 4 e 5 di A6).

⁴⁾ Da concordare: requisiti supplementari S75 di ASTM A 913/A913M: Re/Rm max. 0,85 e Re max. 450 MPa [65 ksi], applicabile alla qualità 50.

⁵⁾ Requisiti addizionali da concordare: prova di resiliencia secondo la tavola A709:07.

* Disponible previo acuerdo.

* Available upon agreement.

* Disponibile previo accordo.

Composición química / Chemical composition / Composizione chimica

Normas Standards Norma	Calidades Grades Tipi	Análisis de colada Ladle analysis Analisi di colata												
		C max. %	Mn %	S max. %	P max. %	Si %	Cu %	Ni %	Cr %	Mo max. %	Nb max. %	V %	CE ¹⁾ max. %	Otros elementos Other elements Altri elementi
A36-05	Grade 36*	0,26	³⁾	0,05	0,04	≤ 0,40 ³⁾	⁷⁾							
A572-07	Grade 42*	0,21	≤ 1,35 ²⁾	0,05	0,04	≤ 0,40 ³⁾	⁷⁾				²⁾	²⁾		²⁾
	Grade 50	0,23	≤ 1,35 ²⁾	0,05	0,04	≤ 0,40 ³⁾	⁷⁾				²⁾	²⁾		²⁾
	Grade 55*	0,25	≤ 1,35 ²⁾	0,05	0,04	≤ 0,40 ³⁾	⁷⁾				²⁾	²⁾		²⁾
	Grade 60*	0,26	≤ 1,35 ²⁾	0,05	0,04	≤ 0,40	⁷⁾				²⁾	²⁾		²⁾
	Grade 65*	0,23 ⁴⁾	≤ 1,65	0,05	0,04	≤ 0,40	⁷⁾				²⁾	²⁾		²⁾
A588-05	Grade B*	0,20	0,75-1,35	0,05	0,04	0,15-0,50	0,20-0,40	≤ 0,5	0,40-0,70			0,01-0,10		
	Grade C*	0,15	0,80-1,35	0,05	0,04	0,15-0,40	0,20-0,50	0,25-0,50	0,30-0,50			0,01-0,10		
A709-07	Grade 36*	0,26	³⁾	0,05	0,04	≤ 0,40 ³⁾	⁷⁾							
	Grade 50	0,23	≤ 1,35 ²⁾	0,05	0,04	≤ 0,40 ³⁾	⁷⁾				²⁾	²⁾		²⁾
	Grade 50S	0,23	0,50-1,60 ²⁾³⁾	0,045	0,035	≤ 0,40 ³⁾	≤ 0,60	≤ 0,45	≤ 0,35	0,15	0,05	≤ 0,15	0,45 ⁶⁾	²⁾⁵⁾
A913-04	Grade 50	0,12	≤ 1,60	0,030	0,040	≤ 0,40	≤ 0,45	≤ 0,25	≤ 0,25	0,07	0,05	≤ 0,06	0,38	
	Grade 65	0,16	≤ 1,60	0,030 ⁴⁾	0,030	≤ 0,40	≤ 0,35	≤ 0,25	≤ 0,25	0,07	0,05	≤ 0,06	0,43	
A992-06a	Grade 50	0,23	0,50-1,60 ²⁾	0,045	0,035	≤ 0,40	≤ 0,60	≤ 0,45	≤ 0,35	0,15	0,05	≤ 0,15	0,45 ⁶⁾	⁵⁾

¹⁾ CE = C + Mn/6 + (Cr + Mo + V)/5 + (Cu + Ni)/15.

²⁾ Véanse las restricciones específicas en la norma.

³⁾ Para perfiles con espesor de ala > 75 mm (3 pulg.): Si mín. 0.15% a 0,4%, (Mn 0.85 - 1.35% para A709 y A36).

⁴⁾ Previo acuerdo: requisito adicional S77 según ASTM A 913/A913M: Azufre máx. 0.010%, aplicable a Calidad 65.

⁵⁾ Nb + V ≤ 0.15%, (N ≤ 0.015% para A992).

⁶⁾ Máx CE = 0.47% para perfiles con un espesor de ala superior a 2 pulg. (50 mm).

⁷⁾ Si se acuerda una calidad con cobre, Cu ≥ 0.20.

¹⁾ CE = C + Mn/6 + (Cr + Mo + V)/5 + (Cu + Ni)/15.

²⁾ See specific limitations in the standard.

³⁾ For shapes with flange thickness over 75 mm (3 in.): Si min. 0.15% to 0,4%, (Mn 0.85 - 1.35% for A709 and A36).

⁴⁾ Upon agreement: supplementary requirement S77 of ASTM A 913/A913M: Sulphur max. 0.010%, applicable to Grade 65.

⁵⁾ Nb + V ≤ 0.15%, (N ≤ 0.015% for A992).

⁶⁾ Max CE = 0.47% for shapes with flange thicknesses over 2 in. (50 mm).

⁷⁾ When copper steel is specified, Cu ≥ 0.20.

¹⁾ CE = C + Mn/6 + (Cr + Mo + V)/5 + (Cu + Ni)/15.

²⁾ Vedere le limitazioni specifiche nello standard.

³⁾ Per i Profili con spessori di ali superiori a 75mm (3 pollici) : Si minimo 0,15% a 0,4%, (Mn 0,85- 1.35% per A709 e A36).

⁴⁾ Da concordare: Requisiti supplementari S77 di ASTM A 913/A913M: zolfo max. 0,010, applicabile alla qualità 65.

⁵⁾ Nb + V ≤ 0,15%, (N ≤ 0,015% per A992).

⁶⁾ Max. CE = 0,47% per i Profili con spessore di ali superiori a 2 pollici (50 mm).

⁷⁾ Se viene richiesto acciaio con rame, Cu ≥ 0,20.

* Disponible previo acuerdo.

* Available upon agreement.

* Disponibile previo accordo.

Tabla 11

Calidades de acero según normas japonesas

Table 11

Steel grades according to Japanese standards

Tavola 11

Tipi di acciaio in conformità alle norme giapponesi

Propiedades mecánicas / Mechanical properties / Caratteristiche meccaniche

Normas Standards Norma	Calidades Grades Tipi	Análisis de colada Ladle analysis Analisi di colata									Ensayo de plegado Bendability Prova di piegatura		
		Límite elástico mínimo R_{eH} Minimum yield strength R_{eH} Limite elastico minimo R_{eH} MPa					Resistencia a la tracción R_m Tensile strength R_m Resistenza alla trazione R_m MPa		Alargamiento mínimo A Minimum elongation A Allungamento minimo A %		Ángulo de plegado Angle of bending Angolo di piegatura	Radio interior Inside radius Raggio interno	
		Espesor nominal (mm) Nominal thickness (mm) Spessore nominale (mm)					Espesor nominal (mm) Nominal thickness (mm) Spessore nominale (mm)		Espesor nominal (mm) Nominal thickness (mm) Spessore nominale (mm)				°
		≤16	>16 ≤40	>40 ≤75	>75 ≤100	>100 ≤125	≤100	>100 ≤125	>5 ≤16	>16 ≤50	>40		
JIS G 3106-2004	SM 400 A*	245	235	215	215	205	400-510	400-510	18	22	24	180	1,5 por espesor 1,5 times the thickness 1,5 x lo spessore
	SM 400 B*					-							
	SM 400 C*	-											
	SM 490 YA* SM 490 YB*	365	355	335	325	-	490-610	-	15	19	21		
JIS G 3101-2004	SS 400*	245	235	215	215	205	400-510	400-510	17	21	23	180	1,5 por espesor 1,5 times the thickness 1,5 x lo spessore
	SS 490*	285	275	255	255	245	490-610	490-610	15	19	21	180	2,0 por espesor 2,0 times the thickness 2,0 x lo spessore
Normas Standards Norma	Calidades Grades Tipi	Ensayo de flexión por choque Notch impact test Prova di resilienza											
		Temperatura Temperature Temperatura					Energía mín. absorbida Min. absorbed energy Energia min. assorbita						
		°C					J						
JIS G 3106-2004	SM 400 A*	-					-						
	SM 400 B*	0					27						
	SM 400 C*	0					47						
	SM 490 YA*	-					-						
	SM 490 YB*	0					27						

* Disponibile previo acuerdo.
* Available upon agreement.
* Disponibile previo accordo.

Composición química / Chemical composition / Composizione chimica

Normas Standards Norma	Calidades Grades Tipi	Análisis de colada Ladle analysis Analisi di colata						
		C* max. %			Mn %	P max. %	S max. %	Si max. %
		Espesor nominal (mm) Nominal thickness (mm) Spessore nominale (mm)						
		≤50	>50 ≤100	>100 ≤125				
J15 G 3106- 2004	SM 400 A*	0,23	0,25	0,25	2,5 x C min. ¹⁾	0,035	0,035	-
	SM 400 B*	0,20	0,22	0,22	0,60-1,40	0,035	0,035	0,35
	SM 400 C*	0,18	0,18	-	1,40 max.	0,035	0,035	0,35
	SM 490 YA*			-				
	SM 490 YB*	0,20	0,20	-	1,60 max.	0,035	0,035	0,55
J15 G 3101- 2004	SS400*		-		-	0,050	0,050	-
	SS490*		-		-	0,050	0,050	-

¹⁾ El valor del carbono indicado corresponde al valor real del análisis de colada.

¹⁾ The value of carbon given here is the actual cast analysis value.

¹⁾ Il valore del carbonio presente corrisponde all'effettivo valore dell'analisi della colata.

Tabla 12

Tablas comparativas de las calidades típicas de acero

Table 12

Comparison tables of typical steel grades

Tavola 12

Tavole comparative delle qualità di acciaio

Aceros estructurales / Structural steels / Acciai strutturali													
EN 10025-2: 2004	Normas anteriores / Previous standards / Norme precedenti										ASTM	CSA G 40- 21	JIS G 3101 JIS G 3106
	EN 10025: 1990 + A1: 1993	EN 10025: 1990	NF A 35-501	DIN 17100	BS4360	UNE 36 080 NBN A21-101	UNI 7070	SS 14	NS 12 101	ÖNORM M1316			
S235JR	S235JR	Fe360B	E24-2	St37-2		AE235B	Fe360B	13 11-00	NS 12 120		A 36	260 W	SS 400 SM 400 A/B/C SS 400
	S235J0	Fe360BFU		Ust37-2		AE235B-FU			NS 12 122	USt 360 B			
S235J2*	S235J2G3	Fe360BFN		RSt37-2	40B	AE235B-FN		13 12-00	NS 12 123	RSt 360 B	300 W	350 W	SS 490
	S235J2G4	Fe360C	E24-3	St37-3U	40C	AE235C	Fe360C		NS 12 124	St 360 C			
S275JR	S275JR	Fe430B	E28-2	St44-2	43B	AE255B	Fe430B	14 12-00	NS 12 142	St 430 B	A 572 Gr.50 A 992 Gr.50	350 W	SS 490
	S275J0	Fe430C	E28-3	St44-3U	43C	AE255C	Fe430C		NS 12 143	St 430 C			
S275J2*	S275J2G3	Fe430D1	E28-4	St44-3N	43D	AE255D	Fe430D	14 14-00	NS 12 143	St 430 D	300 W	350 W	SS 490
	S275J2G4	Fe430D2						14 14-01					
S355JR	S355JR	Fe510B	E36-2		50B	AE355B	Fe510B				A 572 Gr.50 A 992 Gr.50	350 W	SS 490
	S355J0	Fe510C	E36-3	St52-3U	50C	AE355C	Fe510C	21 32-01	NS 12 153	St 510 C			
S355J2	S355J2G3	Fe510D1		St52-3N	50D	AE355D	Fe510D		NS 12 153	St 510 D	300 W	350 W	SS 490
	S355J2G4	Fe510D2						21 34-01					
S355K2	S355K2G3	Fe510DD1	E36-4		50DD	AE355-DD							
S450J0					55C								
E295	E295	Fe490-2	A50-2	St50-2		A490-2	Fe490	15 50-00/ -01		St 490			
E335	E335	Fe590-2	A60-2	St60-2		A590-2	Fe590	16 50-00/ -01		St 590			
E360	E360	Fe690-2	A70-2	St70-2		A690-2	Fe690	16 55-00/ -01		St 690			

* Disponible previo acuerdo.
* Available upon agreement.
* Disponibile previo accordo.

Aceros de alta resistencia con alta tenacidad a la entalla / High strength steels with high notch toughness / Acciaio ad alta resistenza con elevate caratteristiche di resilienza

EN 10025-4: 2004	Normas anteriores / Previous Standards / Norme precedenti						ASTM	CSA G 40-21	JIS G 3101
	EN 10113-3: 1993	NF A 35-504 NF A 36-201	DIN 17102	BS 4360	UNI 7382	SS 14			

S355M	S355M	E355	St E 355	50 D	Fe E 355 KG	21 34-01	A 913 Gr.50		
S355ML	S355ML		TSt E 355	50 EE	Fe E 355 KT	21 35-01		400 W	
		E375							SM 490 YA SM 490 YB
S460M	S460M	E460R	St E 460	55 C	Fe E 460 KG		A 913 Gr.65		SM 570
S460ML	S 460ML	E460FP	TSt E 460	55 EE	Fe E 460 KT				

Tabla comparativa de calidades HISTAR® / Comparison table for HISTAR® grades / Tavola comparativa per qualità HISTAR®

HISTAR®	Normas anteriores / Previous Standards / Norme precedenti						ASTM A 572 ASTM A 913	ASTM A 992	JIS G 3106
	EN 10025-2	EN 10025-4	NF A 35-504 NF A 36-201	NF A 35-501	BS 4360	DIN 17100			

355	S355	S355	E355	E36	50 D	St 52-3	St E 355	Gr.50	Gr.50	SM 490 B/C/YB
460	S450	S460	E460		55 C		St E 460	Gr.65		SM 570

* Disponibile previo acuerdo.
* Available upon agreement.
* Disponibile previo accordo.



Datos técnicos

190	Factores del perfil (resistencia al fuego)
199	Notaciones y fórmulas
203	Clasificación de las secciones transversales
204	Tolerancias de laminación
204	13. Perfiles
206	14. Vigas alveolares
207	15. Perfiles en U y viguetas
208	16. Barras comerciales
212	Tabla de conversión
213	Coefficientes materiales del acero estructural

Technical data

190	Section factors (fire resistance)
199	Notations and formulae
203	Classification of cross-sections
204	Rolling tolerances
204	13. Beams
206	14. Castellated beams
207	15. Channels & joists
208	16. Merchant bars
212	Conversion table
213	Material coefficients of structural steel

Dati tecnici

190	Coefficienti di massa e di esposizione (resistenza al fuoco)
199	Annotazioni e formule
203	Classificazione delle sezioni trasversali
204	Tolleranze di laminazione
204	13. Profili
206	14. Travi alveolari
207	15. Profili U e Travi
208	16. Laminati mercantili
212	Tavole di conversione
213	Proprietà degli acciai strutturali

Factores del perfil Am/V y Ap/V [m⁻¹]

Factores usados en el diseño de la protección contraincendios conforme a la norma EN 1993-1-2: 2005

Section factors Am/V and Ap/V [m⁻¹]

Factors used in fire design in accordance with EN 1993-1-2: 2005

Coefficienti del profilato Am/V e Ap/V [m⁻¹]

Coefficienti utilizzati nella progettazione antincendio in conformità con EN 1993-1-2: 2005



IPE	Am/V	Ap/V	Am/V	Ap/V
IPE AA 80	442	515	320	393
IPE 80 A	437	509	317	389
IPE 80	369	429	270	330
IPE AA 100	398	463	292	357
IPE A 100	389	452	286	349
IPE 100	334	387	247	300
IPE AA 120	382	442	280	340
IPE A 120	370	428	271	329
IPE 120	311	360	230	279
IPE AA 140	369	426	270	327
IPE A 140	354	409	260	314
IPE 140	291	335	215	259
IPE AA 160	350	403	256	309
IPE A 160	332	382	245	295
IPE 160	269	310	200	241
IPE AA 180	316	364	233	281
IPE A 180	308	354	227	274
IPE 180	253	291	188	226
IPE O 180	226	260	168	202
IPE AA 200	290	334	215	259
IPE A 200	283	326	210	253
IPE 200	235	270	176	211
IPE O 200	212	244	158	190
IPE AA 220	271	312	201	242
IPE A 220	260	298	193	231
IPE 220	221	254	165	198
IPE O 220	200	230	149	179
IPE AA 240	251	289	187	225
IPE A 240	240	276	178	214
IPE 240	205	236	153	184
IPE O 240	185	213	139	167
IPE A 270	230	265	171	205
IPE 270	197	227	147	176
IPE O 270	170	195	127	152
IPE A 300	216	248	160	192
IPE 300	188	216	139	167
IPE O 300	163	187	121	145
IPE A 330	199	228	149	178
IPE 330	175	200	131	157
IPE O 330	152	175	114	137
IPE A 360	185	211	138	165
IPE 360	163	186	122	146
IPE O 360	142	162	107	127
IPE A 400	176	200	133	158
IPE 400	152	174	116	137
IPE O 400	135	154	103	122



IPE	Am/V	Ap/V	Am/V	Ap/V
IPE A 450	165	187	127	149
IPE 450	143	162	110	130
IPE O 450	122	138	94	110
IPE A 500	152	172	118	138
IPE 500	134	151	104	121
IPE O 500	114	129	89	104
IPE A 550	142	160	111	129
IPE 550	124	140	97	113
IPE O 550	108	121	85	98
IPE A 600	131	147	103	119
IPE 600	115	129	91	105
IPE O 600	93	104	73	85
IPE 750 x 137	128	144	101	116
IPE 750 x 147	120	134	94	109
IPE 750 x 173	102	114	81	93
IPE 750 x 196	91	102	72	83



IPN	Am/V	Ap/V	Am/V	Ap/V
IPN 80	346	401	266	322
IPN 100	302	349	236	283
IPN 120	268	309	210	251
IPN 140	238	274	189	225
IPN 160	220	252	173	205
IPN 180	200	229	158	188
IPN 200	185	212	147	174
IPN 220	171	196	136	161
IPN 240	160	183	127	150
IPN 260	149	170	119	140
IPN 280	139	158	111	131
IPN 300	131	149	105	123
IPN 320	123	140	99	116
IPN 340	117	133	94	110
IPN 360	110	125	89	104
IPN 380	105	119	85	99
IPN 400	100	113	81	94
IPN 450	89	101	73	84
IPN 500	81	91	66	77
IPN 550	75	85	61	71
IPN 600	68	76	56	64



HE	Am/V	Ap/V	Am/V	Ap/V
HE 100 AA	290	355	181	245
HE 100 A	217	264	138	185
HE 100 B	180	218	115	154
HE 100 C	125	151	82	108
HE 100 M	96	116	65	85
HE 120 AA	296	361	182	247
HE 120 A	220	267	137	185
HE 120 B	167	202	106	141
HE 120 C	118	143	77	101
HE 120 M	92	111	61	80
HE 140 AA	281	342	172	233
HE 140 A	208	253	129	174
HE 140 B	155	187	98	130
HE 140 C	112	135	72	95
HE 140 M	88	106	58	76
HE 160 AA	244	297	150	203
HE 160 A	192	234	120	161
HE 160 B	140	169	88	118
HE 160 C	104	125	67	88
HE 160 M	83	100	54	71
HE 180 AA	229	279	141	190
HE 180 A	187	226	115	155
HE 180 B	131	159	83	110
HE 180 C	99	120	63	84
HE 180 M	80	96	52	68
HE 200 AA	211	256	130	175
HE 200 A	174	211	108	145
HE 200 B	122	147	77	102
HE 200 C	93	113	60	79
HE 200 M	76	92	49	65
HE 220 AA	200	242	122	165
HE 220 A	161	195	99	134
HE 220 B	115	140	72	97
HE 220 C	89	108	57	76
HE 220 M	73	88	47	62
HE 240 AA	185	225	114	154
HE 240 A	147	178	91	122
HE 240 B	108	131	68	91
HE 240 C	77	93	50	66
HE 240 M	61	73	39	52
HE 260 AA	176	214	108	146
HE 260 A	141	171	88	117
HE 260 B	105	127	66	88
HE 260 C	76	91	48	64
HE 260 M	59	72	39	51

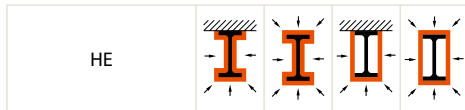

HE	AA	A	B	M
HE 280 AA	168	204	104	139
HE 280 A	136	165	84	113
HE 280 B	102	123	64	85
HE 280 C	74	89	47	63
HE 280 M	59	71	38	50
HE 300 AA	158	192	97	131
HE 300 A	126	153	78	105
HE 300 B	96	116	60	80
HE 300 C	66	79	42	56
HE 300 M	50	60	33	43
HE 320 AA	152	184	95	127
HE 320 A	117	141	74	98
HE 320 B	91	110	58	77
HE 320 C	64	77	42	54
HE 320 M	50	60	33	43
HE 340 AA	147	177	94	123
HE 340 A	112	134	72	94
HE 340 B	88	106	57	75
HE 340 M	50	60	34	43
HE 360 AA	142	170	92	120
HE 360 A	107	128	70	91
HE 360 B	86	102	56	73
HE 360 M	51	61	34	44
HE 400 AA	135	161	90	115
HE 400 A	101	120	68	87
HE 400 B	82	97	56	71
HE 400 M	52	62	36	45
HE 450 AA	133	156	91	114
HE 450 A	96	113	66	83
HE 450 B	79	93	55	69
HE 450 M	53	62	38	47
HE 500 AA	130	152	91	113
HE 500 A	92	107	65	80
HE 500 B	76	89	54	67
HE 500 M	55	63	39	48
HE 550 AA	123	142	88	108
HE 550 A	90	104	65	79
HE 550 B	76	88	55	67
HE 550 M	56	64	41	50
HE 600 AA	120	138	88	106
HE 600 A	89	102	65	79
HE 600 B	75	86	56	67
HE 600 M	57	65	42	51
HE 600 x 337	49	56	37	44
HE 600 x 399	42	48	32	38

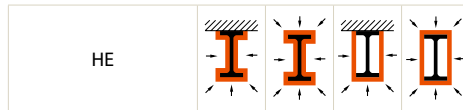

HE	AA	A	B	M
HE 650 AA	118	135	88	105
HE 650 A	87	100	65	78
HE 650 B	74	85	56	66
HE 650 M	58	66	44	52
HE 650 x 343	50	57	38	45
HE 650 x 407	43	49	33	39
HE 700 AA	114	129	86	102
HE 700 A	85	96	64	76
HE 700 B	72	82	55	65
HE 700 M	59	67	45	53
HE 700 x 352	51	58	39	46
HE 700 x 418	44	50	34	40
HE 800 AA	108	122	84	98
HE 800 A	84	94	66	76
HE 800 B	72	81	57	66
HE 800 M	60	68	48	55
HE 800 x 373	52	59	41	48
HE 800 x 444	44	50	35	41
HE 900 AA	101	113	81	93
HE 900 A	81	90	65	74
HE 900 B	70	78	57	65
HE 900 M	62	69	50	57
HE 900 x 391	54	60	43	49
HE 900 x 466	45	51	37	42
HE 1000 AA	98	108	79	90
HE 1000 x 249	88	97	71	81
HE 1000 A	81	89	66	74
HE 1000 B	70	78	57	65
HE 1000 M	64	70	52	59
HE 1000 x 393	57	63	47	53
HE 1000 x 415	54	60	44	50
HE 1000 x 438	51	57	42	48
HE 1000 x 494	46	51	38	43
HE 1000 x 584	39	44	33	37

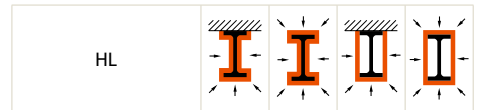

HL	AA	A	B	M
HL 920 X 342	69	78	51	61
HL 920 X 365	65	74	48	57
HL 920 X 387	61	70	46	54
HL 920 X 417	57	65	43	51
HL 920 X 446	53	61	40	48
HL 920 X 488	49	56	37	44
HL 920 X 534	45	51	34	40
HL 920 X 585	42	47	31	37
HL 920 X 653	38	43	29	34
HL 920 X 784	32	36	24	29
HL 920 X 967	26	30	20	24
HL 920 x 344	69	79	52	62
HL 920 x 368	65	74	49	58
HL 920 x 390	62	70	46	55
HL 920 x 420	58	66	43	51
HL 920 x 449	54	61	41	48
HL 920 x 491	50	56	37	44
HL 920 x 537	46	52	35	41
HL 920 x 588	42	48	32	37
HL 920 x 656	38	43	29	34
HL 920 x 725	35	39	26	31
HL 920 x 787	32	37	25	29
HL 920 x 970	27	30	20	24
HL 1000 AA	82	92	63	73
HL 1000 A	76	85	58	68
HL 1000 B	66	74	51	59
HL 1000 M	60	67	46	54
HL 1000 x 443	55	63	43	50
HL 1000 x 483	51	58	40	46
HL 1000 x 539	46	52	36	42
HL 1000 x 554	45	51	35	41
HL 1000 x 591	42	48	33	39
HL 1000 x 642	39	44	31	36
HL 1000 x 748	34	38	27	31
HL 1000 x 883	29	33	23	27
HL 1100 A	76	85	59	68
HL 1100 B	67	75	52	60
HL 1100 M	61	68	47	55
HL 1100 R	53	59	42	48

Factores del perfil Am/V y Ap/V [m⁻¹] (continúa)

Factores usados en el diseño de la protección contraincendios conforme a la norma EN 1993-1-2: 2005

Section factors Am/V and Ap/V [m⁻¹] (continued)

Factors used in fire design in accordance with EN 1993-1-2: 2005

Coefficienti del profilato Am/V e Ap/V [m⁻¹] (continua)

Coefficienti utilizzati nella progettazione antincendio in conformità con EN 1993-1-2: 2005



HD	I-beam	H-beam	U-channel	Z-channel
HD 260 x 54,1	176	214	108	146
HD 260 x 68,2	141	171	88	117
HD 260 x 93,0	105	127	66	88
HD 260 x 114	86	104	55	73
HD 260 x 142	71	86	46	60
HD 260 x 172	59	72	39	51
HD 320 x 74,2	152	184	95	127
HD 320 x 97,6	117	141	74	98
HD 320 x 127	91	110	58	77
HD 320 x 158	74	89	48	63
HD 320 x 198	60	72	39	51
HD 320 x 245	50	60	33	43
HD 320 x 300	42	50	28	36
HD 360 x 134	104	125	63	85
HD 360 x 147	95	114	58	78
HD 360 x 162	87	105	53	71
HD 360 x 179	79	95	49	65
HD 360 x 196	72	87	45	60
HD 400 x 187	78	94	47	64
HD 400 x 216	68	82	42	56
HD 400 x 237	63	76	38	52
HD 400 x 262	57	69	35	47
HD 400 x 287	52	63	32	43
HD 400 x 314	48	58	30	40
HD 400 x 347	44	53	28	37
HD 400 x 382	40	49	25	34
HD 400 x 421	37	45	23	31
HD 400 x 463	34	41	22	29
HD 400 x 509	31	38	20	27
HD 400 x 551	29	35	19	25
HD 400 x 592	28	33	18	23
HD 400 x 634	26	31	17	22
HD 400 x 677	25	30	16	21
HD 400 x 744	23	27	15	20
HD 400 x 818	21	25	14	18
HD 400 x 900	19	23	13	17
HD 400 x 990	18	22	12	16
HD 400 x 1086	17	20	11	15



HP	I-beam	H-beam	U-channel	Z-channel
HP 200 x 43	181	219	112	150
HP 200 x 53	145	176	90	121
HP 220 x 57	143	174	88	119
HP 260 x 75	129	156	80	108
HP 260 x 87	111	135	70	94
HP 305 x 79	147	178	91	121
HP 305 x 88	132	159	81	109
HP 305 x 95	122	148	76	101
HP 305 x 110	106	129	66	88
HP 305 x 126	94	113	58	78
HP 305 x 149	80	97	50	67
HP 305 x 180	67	81	42	56
HP 305 x 186	65	79	41	55
HP 305 x 223	55	67	35	47
HP 320 x 88	128	155	81	108
HP 320 x 103	111	135	70	94
HP 320 x 117	98	119	62	83
HP 320 x 147	80	96	51	68
HP 320 x 184	65	78	42	55
HP 360 x 109	126	153	77	103
HP 360 x 133	104	126	64	86
HP 360 x 152	92	111	56	76
HP 360 x 174	81	98	50	67
HP 360 x 180	78	95	48	65
HP 400 x 122	116	141	70	95
HP 400 x 140	102	124	61	83
HP 400 x 158	91	111	55	74
HP 400 x 176	82	100	50	67
HP 400 x 194	75	91	46	62
HP 400 x 213	69	84	42	57
HP 400 x 231	64	77	39	53



UPE	U-channel	Z-channel	U-channel	Z-channel
UPE 80	291	341	209	258
UPE 100	278	322	204	248
UPE 120	259	298	195	233
UPE 140	247	282	187	223
UPE 160	235	267	180	212
UPE 180	225	254	173	203
UPE 200	213	240	165	193
UPE 220	198	223	155	180
UPE 240	188	211	148	171
UPE 270	178	199	142	163
UPE 300	153	171	124	141
UPE 330	138	153	113	128
UPE 360	130	144	107	121
UPE 400	120	133	100	112

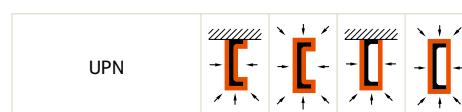

UPN	U-channel	Z-channel	U-channel	Z-channel
UPN 50	278	331	194	247
UPN 65	264	311	190	237
UPN 80	250	291	186	227
UPN 100	239	276	185	222
UPN 120	223	255	174	206
UPN 140	210	240	167	196
UPN 160	200	228	160	188
UPN 180	193	218	154	179
UPN 200	182	205	148	171
UPN 220	171	192	139	160
UPN 240	163	183	134	154
UPN 260	154	173	126	145
UPN 280	149	167	123	141
UPN 300	145	162	119	136
UPN 320	116	130	98	111
UPN 350	123	135	103	116
UPN 380	125	138	107	120
UPN 400	117	129	99	111



U 40 x 20	347	402	273	328
U 50 x 25	328	379	254	305
U 60 x 30	299	346	232	279
U 65 x 42	264	311	190	237



UE 80	298	343	226	271
UE 100	297	340	228	270
UE 120	288	327	223	262
UE 140	281	318	219	256
UE 160	274	310	215	250
UE 180	268	302	210	244
UE 200	262	294	206	239

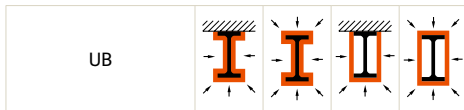

UB 127 x 76 x 13	279	325	200	246
UB 152 x 89 x 16	270	314	194	237
UB 178 x 102 x 19	262	304	188	230
UB 203 x 102 x 23	234	269	173	207
UB 203 x 133 x 25	244	286	169	210
UB 203 x 133 x 30	207	242	143	178
UB 254 x 102 x 22	281	318	218	254
UB 254 x 102 x 25	248	280	192	224
UB 254 x 102 x 28	222	251	173	201
UB 254 x 146 x 31	231	268	164	200
UB 254 x 146 x 37	196	227	140	171
UB 254 x 146 x 43	170	197	122	149



UB 305 x 102 x 25	282	314	225	257
UB 305 x 102 x 28	250	279	200	229
UB 305 x 102 x 33	217	241	174	198
UB 305 x 127 x 37	201	227	155	181
UB 305 x 127 x 42	179	202	138	162
UB 305 x 127 x 48	158	178	122	143
UB 305 x 165 x 40	209	242	150	183
UB 305 x 165 x 46	184	212	133	161
UB 305 x 165 x 54	159	183	115	139
UB 356 x 127 x 33	248	278	195	225
UB 356 x 127 x 39	212	237	167	193
UB 356 x 171 x 45	207	236	152	182
UB 356 x 171 x 51	184	210	136	162
UB 356 x 171 x 57	165	189	122	146
UB 356 x 171 x 67	142	162	105	126
UB 406 x 140 x 39	240	268	189	217
UB 406 x 140 x 46	205	229	162	186
UB 406 x 178 x 54	189	215	143	168
UB 406 x 178 x 60	172	195	129	153
UB 406 x 178 x 67	154	175	117	138
UB 406 x 178 x 74	140	159	106	125
UB 457 x 152 x 52	199	222	158	181
UB 457 x 152 x 60	175	195	139	159
UB 457 x 152 x 67	157	175	125	143
UB 457 x 152 x 74	143	159	114	130
UB 457 x 152 x 82	130	145	104	119
UB 457 x 191 x 67	169	191	128	150
UB 457 x 191 x 74	153	173	117	137
UB 457 x 191 x 82	139	158	106	125
UB 457 x 191 x 89	129	146	98	115
UB 457 x 191 x 98	118	133	90	105
UB 533 x 210 x 82	157	177	121	141
UB 533 x 210 x 92	141	159	109	126
UB 533 x 210 x 101	129	145	100	116
UB 533 x 210 x 109	120	135	93	108
UB 533 x 210 x 122	108	122	84	97

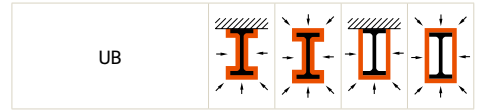

UB 610 x 229 x 101	143	161	111	129
UB 610 x 229 x 113	129	145	100	116
UB 610 x 229 x 125	117	131	91	106
UB 610 x 229 x 140	105	118	82	95
UB 610 x 305 x 149	110	126	80	97
UB 610 x 305 x 179	92	106	68	81
UB 610 x 305 x 238	71	81	52	62
UB 686 x 254 x 125	130	145	101	117
UB 686 x 254 x 140	116	131	91	105
UB 686 x 254 x 152	107	121	84	97
UB 686 x 254 x 170	97	109	76	88
UB 762 x 267 x 134	131	147	103	119
UB 762 x 267 x 147	120	134	95	109
UB 762 x 267 x 173	103	115	81	93
UB 762 x 267 x 197	91	102	72	83
UB 838 x 292 x 176	111	124	88	101
UB 838 x 292 x 194	101	113	80	92
UB 838 x 292 x 226	87	98	69	79
UB 914 x 305 x 201	104	116	82	94
UB 914 x 305 x 224	93	104	74	85
UB 914 x 305 x 253	83	93	66	76
UB 914 x 305 x 289	73	82	59	67
UB 914 x 419 x 343	69	78	51	61
UB 914 x 419 x 388	61	70	46	54
UB 1016 x 305 x 222	98	108	79	90
UB 1016 x 305 x 249	88	97	71	81
UB 1016 x 305 x 272	81	89	66	74
UB 1016 x 305 x 314	70	78	58	65
UB 1016 x 305 x 350	64	70	52	59
UB 1016 x 305 x 393	57	63	47	53
UB 1016 x 305 x 415	54	60	44	50
UB 1016 x 305 x 438	51	57	42	48
UB 1016 x 305 x 494	46	51	38	43
UB 1016 x 305 x 584	39	44	33	37

Factores del perfil Am/V y Ap/V [m⁻¹] (continúa)



Factores usados en el diseño de la protección contraincendios conforme a la norma EN 1993-1-2: 2005

Section factors Am/V and Ap/V [m⁻¹] (continued)

Factors used in fire design in accordance with EN 1993-1-2: 2005

Coefficienti del profilato Am/V e Ap/V [m⁻¹] (continua)





Coefficienti utilizzati nella progettazione antincendio in conformità con EN 1993-1-2: 2005

J				
---	---	---	---	---

J 76 x 76 x 13	220	268	142	190
J 76 x 76 x 15	191	234	123	166
J 89 x 89 x 19	169	205	109	146
J 102 x 44 x 7	335	383	263	311
J 102 x 102 x 23	163	198	106	141
J 114 x 114 x 27	155	189	101	135
J 127 x 76 x 16	217	254	158	195
J 127 x 114 x 27	164	198	109	143
J 127 x 114 x 29	151	182	100	131
J 152 x 127 x 37	137	164	92	119
J 203 x 152 x 52	124	147	85	108
J 254 x 114 x 37	174	198	133	157
J 254 x 203 x 82	102	121	68	88

UC				
----	---	---	---	--



UC 152 x 152 x 23	252	304	156	208
UC 152 x 152 x 30	195	235	122	162
UC 152 x 152 x 37	161	194	101	134
UC 203 x 203 x 46	168	202	104	139
UC 203 x 203 x 52	150	180	93	124
UC 203 x 203 x 60	131	158	82	109
UC 203 x 203 x 71	112	135	71	93
UC 203 x 203 x 86	94	113	60	79
UC 254 x 254 x 73	132	160	82	109
UC 254 x 254 x 89	110	133	69	91
UC 254 x 254 x 107	93	112	58	77
UC 254 x 254 x 132	76	92	48	64
UC 254 x 254 x 167	62	74	40	52
UC 305 x 305 x 97	120	145	75	99
UC 305 x 305 x 118	100	120	62	83
UC 305 x 305 x 137	87	105	54	72
UC 305 x 305 x 158	76	91	48	63
UC 305 x 305 x 198	62	74	39	52
UC 305 x 305 x 240	52	62	33	44
UC 305 x 305 x 283	45	54	29	38
UC 356 x 368 x 129	108	130	66	88
UC 356 x 368 x 153	92	111	56	75
UC 356 x 368 x 177	80	96	49	66
UC 356 x 368 x 202	71	85	44	58
UC 356 x 406 x 235	63	76	39	52
UC 356 x 406 x 287	52	63	32	43
UC 356 x 406 x 340	45	54	28	37
UC 356 x 406 x 393	39	48	25	33
UC 356 x 406 x 467	34	41	22	29
UC 356 x 406 x 551	29	35	19	25
UC 356 x 406 x 634	26	31	17	22

UBP				
-----	---	---	---	---

UBP 203 x 203 x 45	172	208	106	142
UBP 203 x 203 x 54	144	174	90	120
UBP 254 x 254 x 63	152	184	94	126
UBP 254 x 254 x 71	136	164	84	112
UBP 254 x 254 x 85	114	138	71	95
UBP 305 x 305 x 79	146	177	90	121
UBP 305 x 305 x 88	132	159	81	109
UBP 305 x 305 x 95	122	148	76	101
UBP 305 x 305 x 110	106	129	66	88
UBP 305 x 305 x 126	94	113	58	78
UBP 305 x 305 x 149	80	97	50	67
UBP 305 x 305 x 186	65	79	41	55
UBP 305 x 305 x 223	55	67	35	47
UBP 356 x 368 x 109	126	153	77	103
UBP 356 x 368 x 133	104	126	64	86
UBP 356 x 368 x 152	92	111	56	76
UBP 356 x 368 x 174	81	98	50	67

PFC				
-----	---	---	---	---

PFC 100 x 50 x 10	254	292	192	231
PFC 125 x 65 x 15	226	261	168	202
PFC 150 x 75 x 18	222	255	165	198
PFC 150 x 90 x 24	181	210	128	158
PFC 180 x 75 x 20	218	247	168	197
PFC 180 x 90 x 26	184	211	136	163
PFC 200 x 75 x 23	203	228	159	184
PFC 200 x 90 x 30	172	195	129	153
PFC 230 x 75 x 26	203	226	164	187
PFC 230 x 90 x 32	171	193	134	156
PFC 260 x 75 x 28	206	228	169	191
PFC 260 x 90 x 35	171	192	137	158
PFC 300 x 90 x 41	159	176	131	148
PFC 300 x 100 x 46	150	167	121	138
PFC 380 x 100 x 54	150	164	125	140
PFC 430 x 100 x 64	149	161	117	129

CH				
----	---	---	---	---

CH 76 x 38 x 7	292	336	221	265
CH 102 x 51 x 10	258	296	193	232
CH 127 x 64 x 15	222	255	169	203
CH 152 x 76 x 18	224	258	169	203
CH 152 x 89 x 24	180	210	131	161
CH 178 x 76 x 21	210	239	164	192
CH 178 x 89 x 27	175	201	132	158
CH 203 x 76 x 24	203	228	159	185
CH 203 x 89 x 30	171	194	132	155
CH 229 x 76 x 26	200	223	161	184
CH 229 x 89 x 33	167	188	132	153
CH 254 x 76 x 28	196	217	163	184
CH 254 x 89 x 36	163	183	132	151
CH 305 x 89 x 42	159	175	132	149
CH 305 x 102 x 46	153	170	122	140
CH 381 x 102 x 55	149	164	124	139
CH 432 x 102 x 65	138	151	117	130



W 100 x 100 x 19,3	201	243	127	169
W 130 x 130 x 23,8	201	243	126	168
W 130 x 130 x 28,1	172	208	109	144
W 150 x 100 x 13,5	336	393	231	289
W 150 x 100 x 18,0	253	297	175	219
W 150 x 100 x 24,0	197	231	138	172
W 150 x 150 x 22,5	259	313	160	213
W 150 x 150 x 29,8	198	238	123	164
W 150 x 150 x 37,1	160	193	101	134
W 200 x 100 x 15,0	354	406	261	313
W 200 x 100 x 19,3	276	317	204	245
W 200 x 100 x 22,5	241	277	179	215
W 200 x 135 x 21	288	338	199	248
W 200 x 135 x 26,6	232	271	161	200
W 200 x 135 x 31,3	199	233	139	172
W 200 x 165 x 35,9	190	226	124	160
W 200 x 165 x 41,7	165	196	108	140
W 200 x 200 x 46,1	168	202	104	139
W 200 x 200 x 52	149	180	93	123
W 200 x 200 x 59	132	159	83	110
W 200 x 200 x 71	111	134	70	93
W 200 x 200 x 86	93	112	59	78
W 200 x 200 x 100	82	99	53	69
W 250 x 100 x 17,9	342	386	264	308
W 250 x 100 x 22,3	275	311	213	248
W 250 x 100 x 25,3	246	277	190	222
W 250 x 100 x 28,4	221	249	172	200
W 250 x 145 x 24	294	341	209	256
W 250 x 145 x 32,7	222	257	159	194
W 250 x 145 x 38,5	190	220	136	166
W 250 x 145 x 44,8	165	191	119	144
W 250 x 200 x 49,1	169	201	111	144
W 250 x 200 x 58	145	172	95	123
W 250 x 200 x 67	127	151	84	108
W 250 x 250 x 73	132	159	82	109
W 250 x 250 x 80	121	146	75	100
W 250 x 250 x 89	109	132	68	90
W 250 x 250 x 101	97	117	61	81
W 250 x 250 x 115	87	104	55	72
W 250 x 250 x 131	77	92	49	64
W 250 x 250 x 149	68	82	44	57
W 250 x 250 x 167	62	74	40	52

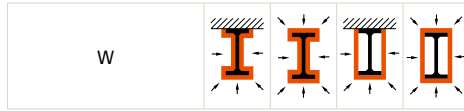

W 310 x 100 x 21,0	329	367	263	301
W 310 x 100 x 23,8	292	326	234	267
W 310 x 100 x 28,3	249	277	200	228
W 310 x 100 x 32,7	216	241	174	198
W 310 x 165 x 31	273	315	197	239
W 310 x 165 x 38,7	220	253	158	192
W 310 x 165 x 44,5	193	222	139	168
W 310 x 165 x 52	166	191	120	145
W 310 x 200 x 60	155	182	107	133
W 310 x 200 x 67	139	163	96	120
W 310 x 200 x 74	126	148	87	109
W 310 x 250 x 79	132	157	86	111
W 310 x 250 x 86	121	145	79	103
W 310 x 310 x 97	120	145	75	99
W 310 x 310 x 107	110	132	68	91
W 310 x 310 x 117	100	121	62	83
W 310 x 310 x 129	91	110	57	76
W 310 x 310 x 143	83	100	52	69
W 310 x 310 x 158	76	92	48	64
W 310 x 310 x 179	68	82	43	57
W 310 x 310 x 202	60	73	39	51
W 310 x 310 x 226	55	66	35	46
W 310 x 310 x 253	49	59	32	42
W 310 x 310 x 283	45	54	29	38
W 310 x 310 x 313	41	49	27	35
W 310 x 310 x 342	38	45	25	32
W 360 x 130 x 32,9	252	282	198	228
W 360 x 130 x 39,0	213	238	167	193
W 360 x 170 x 44,6	207	237	153	183
W 360 x 170 x 51	185	211	136	163
W 360 x 170 x 58	166	190	123	147
W 360 x 200 x 64	154	179	110	135
W 360 x 200 x 72	139	161	99	122
W 360 x 200 x 79	126	147	90	111
W 360 x 250 x 91	123	145	83	105
W 360 x 250 x 101	111	131	75	95
W 360 x 250 x 110	103	121	70	88
W 360 x 250 x 122	94	110	63	80
W 360 x 370 x 134	104	125	63	85
W 360 x 370 x 147	95	114	58	78
W 360 x 370 x 162	87	105	53	71
W 360 x 370 x 179	79	95	49	65
W 360 x 370 x 196	72	87	45	60

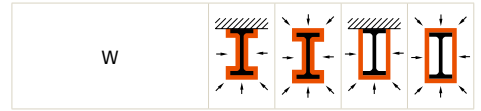

W 360 x 410 x 216	68	82	42	56
W 360 x 410 x 237	63	76	38	52
W 360 x 410 x 262	57	69	35	47
W 360 x 410 x 287	52	63	32	43
W 360 x 410 x 314	48	58	30	40
W 360 x 410 x 347	44	53	28	37
W 360 x 410 x 382	40	49	25	34
W 360 x 410 x 421	37	45	23	31
W 360 x 410 x 463	34	41	22	29
W 360 x 410 x 509	31	38	20	27
W 360 x 410 x 551	29	35	19	25
W 360 x 410 x 592	28	33	18	23
W 360 x 410 x 634	26	31	17	22
W 360 x 410 x 677	25	30	16	21
W 360 x 410 x 744	23	27	15	20
W 360 x 410 x 818	21	25	14	18
W 360 x 410 x 900	19	23	13	17
W 360 x 410 x 990	18	22	12	16
W 360 x 410 x 1086	17	20	11	15
W 410 x 140 x 38,8	239	267	189	217
W 410 x 140 x 46,1	203	227	161	185
W 410 x 180 x 53	192	218	145	171
W 410 x 180 x 60	174	197	131	154
W 410 x 180 x 67	154	175	116	137
W 410 x 180 x 75	140	159	106	125
W 410 x 180 x 85	124	140	94	110
W 410 x 260 x 100	124	144	86	106
W 410 x 260 x 114	108	126	76	93
W 410 x 260 x 132	95	111	66	82
W 410 x 260 x 149	85	99	59	73
W 460 x 150 x 52	200	223	159	182
W 460 x 150 x 60	176	196	140	160
W 460 x 150 x 68	154	172	123	141
W 460 x 190 x 61	187	212	143	167
W 460 x 190 x 67	168	191	128	151
W 460 x 190 x 74	153	173	117	137
W 460 x 190 x 82	139	158	106	125
W 460 x 190 x 89	129	145	98	115
W 460 x 190 x 97	119	135	91	107
W 460 x 190 x 106	110	124	84	99

Factores del perfil Am/V y Ap/V [m⁻¹] (continúa)

Factores usados en el diseño de la protección contraincendios conforme a la norma EN 1993-1-2: 2005

Section factors Am/V and Ap/V [m⁻¹] (continued)

Factors used in fire design in accordance with EN 1993-1-2: 2005

Coefficienti del profilato Am/V e Ap/V [m⁻¹] (continua)

Coefficienti utilizzati nella progettazione antincendio in conformità con EN 1993-1-2: 2005

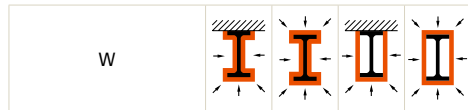

W				
W 460 x 280 x 113	120	139	84	103
W 460 x 280 x 128	106	124	74	92
W 460 x 280 x 144	95	110	67	82
W 460 x 280 x 158	87	102	62	76
W 460 x 280 x 177	78	91	55	68
W 460 x 280 x 193	72	84	51	63
W 460 x 280 x 213	66	77	47	58
W 460 x 280 x 235	60	70	43	53
W 460 x 280 x 260	55	64	39	48
W 530 x 165 x 66	180	199	145	165
W 530 x 165 x 74	159	176	128	146
W 530 x 165 x 85	141	157	115	130
W 530 x 210 x 92	140	158	108	126
W 530 x 210 x 101	128	145	99	115
W 530 x 210 x 109	120	135	93	108
W 530 x 210 x 123	107	120	83	96
W 530 x 210 x 138	96	108	74	87
W 610 x 180 x 82	162	179	132	149
W 610 x 180 x 92	145	160	118	133
W 610 x 230 x 101	142	160	110	128
W 610 x 230 x 113	128	144	100	116
W 610 x 230 x 125	117	131	91	105
W 610 x 230 x 140	105	118	82	95
W 610 x 230 x 153	97	108	75	87
W 610 x 325 x 155	109	125	78	95
W 610 x 325 x 174	97	112	70	85
W 610 x 325 x 195	87	100	63	76
W 610 x 325 x 217	79	91	57	69
W 610 x 325 x 241	73	83	53	64
W 610 x 325 x 262	66	76	48	58
W 610 x 325 x 285	61	70	45	54
W 610 x 325 x 341	52	60	38	46
W 610 x 325 x 415	43	50	32	38
W 610 x 325 x 455	40	46	30	36
W 610 x 325 x 498	37	42	27	33
W 610 x 325 x 551	34	39	25	30
W 690 x 250 x 125	129	145	101	116

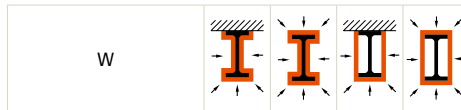

W				
W 690 x 250 x 140	117	131	91	105
W 690 x 250 x 152	108	121	84	97
W 690 x 250 x 170	97	109	76	88
W 690 x 250 x 192	87	97	68	78
W 760 x 265 x 147	120	134	94	109
W 760 x 265 x 161	110	123	87	100
W 760 x 265 x 173	102	114	81	93
W 760 x 265 x 185	97	108	76	88
W 760 x 265 x 196	91	102	72	83
W 760 x 265 x 220	82	91	65	74
W 840 x 295 x 176	111	124	88	101
W 840 x 295 x 193	101	113	80	92
W 840 x 295 x 210	93	104	74	85
W 840 x 295 x 226	87	97	69	79
W 840 x 295 x 251	79	88	63	72
W 920 x 310 x 201	104	115	82	94
W 920 x 310 x 223	93	104	74	85
W 920 x 310 x 238	88	98	70	80
W 920 x 310 x 253	83	93	66	76
W 920 x 310 x 271	78	87	62	71
W 920 x 310 x 289	74	82	59	67
W 920 x 310 x 313	68	76	55	62
W 920 x 420 x 342	69	78	51	61
W 920 x 420 x 365	65	74	48	57
W 920 x 420 x 387	61	70	46	54
W 920 x 420 x 417	57	65	43	51
W 920 x 420 x 446	53	61	40	48
W 920 x 420 x 488	49	56	37	44
W 920 x 420 x 534	45	51	34	40
W 920 x 420 x 585	42	47	31	37
W 920 x 420 x 653	38	43	29	34
W 920 x 420 x 784	32	36	24	29
W 920 x 420 x 967	26	30	20	24
W 920 x 420 x 344	69	79	52	62
W 920 x 420 x 368	65	74	49	58
W 920 x 420 x 390	62	70	46	55
W 920 x 420 x 420	58	66	43	51
W 920 x 420 x 449	54	61	41	48
W 920 x 420 x 491	50	56	37	44
W 920 x 420 x 537	46	52	35	41
W 920 x 420 x 588	42	48	32	37
W 920 x 420 x 656	38	43	29	34
W 920 x 420 x 725	35	39	26	31
W 920 x 420 x 787	32	37	25	29
W 920 x 420 x 970	27	30	20	24



W				
W 1000 x 300 x 222	97	108	79	90
W 1000 x 300 x 249	88	97	71	81
W 1000 x 300 x 272	81	89	66	74
W 1000 x 300 x 314	70	78	57	65
W 1000 x 300 x 350	64	70	52	59
W 1000 x 300 x 393	57	63	47	53
W 1000 x 300 x 415	54	60	44	50
W 1000 x 300 x 438	51	57	42	48
W 1000 x 300 x 494	46	51	38	43
W 1000 x 300 x 584	39	44	33	37
W 1000 x 400 x 296	82	92	63	73
W 1000 x 400 x 321	76	85	58	68
W 1000 x 400 x 371	66	74	51	59
W 1000 x 400 x 412	60	67	46	54
W 1000 x 400 x 443	56	63	43	50
W 1000 x 400 x 483	51	58	40	46
W 1000 x 400 x 539	46	52	36	42
W 1000 x 400 x 554	45	51	35	41
W 1000 x 400 x 591	42	48	33	38
W 1000 x 400 x 642	39	44	31	36
W 1000 x 400 x 748	34	39	27	31
W 1000 x 400 x 883	29	33	23	27
W 1100 x 400 x 343	76	85	59	68
W 1100 x 400 x 390	67	75	52	60
W 1100 x 400 x 433	61	68	47	55
W 1100 x 400 x 499	53	59	42	48

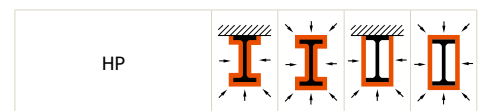

HP				
HP 200 x 43	181	219	112	150
HP 200 x 53	145	176	90	121
HP 250 x 62	152	185	94	126
HP 250 x 85	114	138	71	95
HP 310 x 79	147	178	91	121
HP 310 x 93	124	150	77	103
HP 310 x 110	106	128	66	88
HP 310 x 125	94	114	59	79
HP 310 x 132	90	109	56	75
HP 360 x 108	127	154	77	104
HP 360 x 132	105	127	64	86
HP 360 x 152	92	111	56	76
HP 360 x 174	81	98	50	67



S 75 x 8,5	287	342	195	249
S 75 x 11,2	228	273	151	196
S 100 x 11,5	268	314	186	232
S 100 x 14,1	222	262	153	193
S 130 x 15	246	286	175	215
S 150 x 18,6	231	267	165	201
S 150 x 25,7	168	196	121	149
S 200 x 27,4	197	227	146	175
S 200 x 34	159	183	117	142
S 250 x 37,8	175	200	130	155
S 250 x 52	127	146	95	114
S 310 x 47,3	161	182	122	143
S 310 x 52	146	166	111	131
S 310 x 60,7	126	144	96	113
S 310 x 74	104	118	79	94
S 380 x 64	141	158	111	128
S 380 x 74	122	137	95	111
S 460 x 81,4	129	144	103	117
S 460 x 104	102	113	81	93
S 510 x 98	117	130	94	107
S 510 x 112	104	115	83	95
S 510 x 128	93	104	74	85
S 510 x 143	84	94	67	77
S 610 x 119	114	125	92	104
S 610 x 134	101	111	82	93
S 610 x 149	91	100	74	84
S 610 x 158	90	100	72	82
S 610 x 180	78	87	63	72

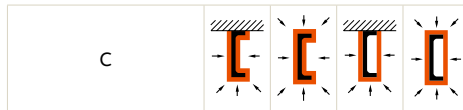

C 75 x 6,1	311	356	241	286
C 75 x 7,4	259	298	201	240
C 75 x 8,9	219	254	170	205
C 100 x 8	301	341	239	278
C 100 x 10,8	225	256	179	210
C 130 x 10,4	285	320	227	263
C 130 x 13	219	247	177	205
C 150 x 12,2	277	308	227	258
C 150 x 15,6	218	244	179	205
C 150 x 19,3	177	199	146	168
C 180 x 14,6	266	295	220	248
C 180 x 18,2	213	237	177	201
C 180 x 22	178	199	148	168
C 200 x 17,1	234	260	213	240
C 200 x 20,5	199	222	179	202
C 200 x 27,9	146	164	132	150
C 230 x 19,9	244	268	204	228
C 230 x 22	219	241	183	205
C 230 x 30	165	182	138	156
C 250 x 22,8	218	240	199	222
C 250 x 30	167	185	153	171
C 250 x 37	141	157	128	144
C 250 x 45	114	127	103	116
C 310 x 30,8	192	210	174	193
C 310 x 37	162	178	146	162
C 310 x 45	131	145	121	135
C 380 x 50,4	150	163	132	145
C 380 x 60	125	137	112	124
C 380 x 74	100	110	90	100



MC 150 x 17,9	205	233	161	189
MC 150 x 22,5	173	199	132	158
MC 150 x 22,8	183	213	135	165
MC 150 x 24,3	159	184	123	147
MC 150 x 26,8	156	182	115	141
MC 180 x 28,4	161	185	122	146
MC 180 x 33,8	137	158	104	125
MC 200 x 12,6	331	361	282	311
MC 200 x 27,8	171	192	136	157
MC 200 x 29,8	159	179	127	147
MC 200 x 31,8	156	178	122	143
MC 200 x 33,9	146	167	115	135
MC 230 x 35,6	151	170	120	139
MC 230 x 37,8	142	160	113	132
MC 250 x 12,5	377	401	342	365
MC 250 x 33	173	193	141	161
MC 250 x 37	156	174	126	144
MC 250 x 42,4	143	161	113	131
MC 250 x 50	122	139	96	113
MC 250 x 61,2	100	114	79	93
MC 310 x 15,8	354	373	322	341
MC 310 x 46	149	165	121	137
MC 310 x 52	131	145	107	121
MC 310 x 60	114	127	93	106
MC 310 x 67	102	114	83	95
MC 310 x 74	93	104	76	87
MC 330 x 47,3	156	172	126	143
MC 330 x 52	141	157	115	131
MC 330 x 60	124	138	101	115
MC 330 x 74	100	112	82	94
MC 460 x 63,5	146	158	125	138
MC 460 x 68,2	137	149	117	129
MC 460 x 77,2	121	131	104	114
MC 460 x 86	109	119	93	103

Factores del perfil Am/V y Ap/V [m⁻¹] (continúa)

Factores usados en el diseño de la protección contraincendios conforme a la norma EN 1993-1-2: 2005

Section factors Am/V and Ap/V [m⁻¹] (continued)

Factors used in fire design in accordance with EN 1993-1-2: 2005

Coefficienti del profilato Am/V e Ap/V [m⁻¹] (continua)

Coefficienti utilizzati nella progettazione antincendio in conformità con EN 1993-1-2: 2005

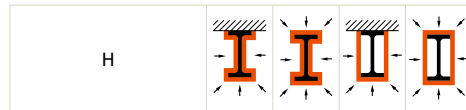

H 100 x 100 x 6 x 8	220	266	139	185
H 125 x 125 x 6,5 x 9	199	241	125	167
H 150 x 75 x 5 x 7	281	323	210	252
H 150 x 150 x 7 x 10	182	220	113	151
H 175 x 175 x 7,5 x 11	163	197	102	136
H 200 x 100 x 4,5 x 7	295	339	218	262
H 200 x 100 x 5,5 x 8	253	291	187	225
H 200 x 150 x 6 x 9	213	253	141	181
H 200 x 200 x 8 x 12	151	183	94	126
H 250 x 125 x 5 x 8	264	303	194	233
H 250 x 125 x 6 x 9	230	264	169	203
H 250 x 250 x 9 x 14	132	160	82	109
H 300 x 150 x 5,5 x 8	247	284	183	219
H 300 x 150 x 6,5 x 9	217	249	160	192
H 300 x 200 x 8 x 12	162	190	111	139
H 300 x 300 x 10 x 15	123	148	76	101
H 350 x 175 x 6 x 9	225	258	165	198
H 350 x 175 x 7 x 11	189	217	139	167
H 350 x 350 x 10 x 16	117	141	72	96
H 350 x 350 x 12 x 19	99	119	61	81
H 400 x 200 x 7 x 11	189	217	139	167
H 400 x 200 x 8 x 13	163	187	120	144
H 400 x 300 x 10 x 16	123	145	81	104
H 400 x 400 x 13 x 21	89	107	55	73
H 400 x 400 x 21 x 21	78	94	48	64
H 400 x 400 x 18 x 28	67	80	42	55
H 400 x 400 x 20 x 35	55	67	35	46
H 400 x 400 x 30 x 50	39	47	25	33
H 500 x 200 x 9 x 14	156	176	120	140
H 500 x 200 x 10 x 16	139	157	107	125
H 500 x 300 x 11 x 15	129	150	90	111
H 500 x 300 x 11 x 18	115	134	80	99
H 600 x 300 x 12 x 17	119	137	87	104
H 600 x 300 x 12 x 20	108	124	79	95
H 600 x 300 x 14 x 23	94	108	69	83
H 700 x 300 x 13 x 20	107	122	81	96
H 700 x 300 x 13 x 24	97	110	73	86
H 800 x 300 x 14 x 22	101	114	79	91
H 800 x 300 x 14 x 26	93	104	72	83
H 900 x 300 x 15 x 23	98	109	78	89
H 900 x 300 x 16 x 28	86	96	69	78
H 900 x 300 x 18 x 34	74	82	59	67

Notaciones y fórmulas

Notations and formulae

Annotazioni e formule

Las designaciones corresponden, en la medida de lo posible, a las del Eurocódigo.

Where possible, the designations correspond to those of the Eurocode.

Le designazioni, ove possibile, corrispondono a quelle dell'Eurocodice.

Las fórmulas que aparecen sobre un fondo coloreado únicamente son válidas para los perfiles I y H con alas paralelas.

The formulae printed on a coloured background are only valid for I and H sections with parallel flanges.

Le formule, stampate su uno sfondo colorato, sono valide esclusivamente per i Profili a I e H a flange parallele.

A área de la sección

A area of section

A area della sezione

$$A = 2 t_f b + (h - 2 t_f) t_w + (4 - \pi) r^2$$

A_G superficie a pintar por unidad de masa

A_G painting surface per unit mass

A_G superficie verniciabile per massa unitaria

$$A_G = \frac{A_L}{A \cdot \rho_a}$$

A_L superficie a pintar por unidad de longitud

A_L painting surface per unit length

A_L superficie verniciabile per lunghezza unitaria

$$A_L = [4(b - 2r) + 2(h - t_w) + 2\pi r] \frac{L}{L}$$

A_m área de la superficie del elemento de acero expuesta al fuego por unidad de longitud

A_m surface area of the steel section exposed to fire per unit length

A_m superficie della sezione d'acciaio esposta al fuoco per lunghezza unitaria

A_{net} área neta de la sección tras deducción de un agujero para tornillo

A_{net} net area of section after deduction of a single bolt hole

A_{net} area netta della sezione portante del profilato al netto di un singolo foro

A_p área de la superficie interna del material de protección contraincendios por unidad de longitud

A_p area of the inner surface of the fire protection material per unit length

A_p area della superficie interna del materiale di protezione al fuoco per lunghezza unitaria

A_{vz} área de cortadura esfuerzo paralelo al alma

A_{vz} shear area load parallel to web

A_{vz} area a taglio carico paralelo all'anima

$$A_{vz} = A - 2 b t_f + (t_w + 2 r) t_f$$

α inclinación de los ejes de inercia principales

α inclination of main axes of inertia

α inclinazione degli assi principali di inerzia

b ancho del perfil

b width of section

b larghezza della sezione

d altura de la parte recta del alma

d depth of straight portion of web

d altezza interna dell'anima

$$d = h - 2 t_f - 2 r$$

Notaciones y fórmulas (continúa)

Notations and formulae (continued)

Annotazioni e formule (continua)

e_{min}, e_{max}
distancias permitidas al borde
para uniones con tornillos,
determinadas para garantizar
una superficie de contacto por
fuera del radio de acuerdo y para
cumplir los requisitos de la norma
EN 1993-1-8:2005 relativa a la
distancia mínima y máxima al borde.
El cumplimiento de estas condiciones
se extiende también a los tornillos con
diámetros inferiores a \emptyset . Los valores se
calculan teniendo en cuenta agujeros
con un juego nominal de 2 mm para
tornillos M10 a M24 y de 3 mm para
tornillos M27.
Se deberá comprobar la estabilidad
frente al pandeo local y, si fuera
necesario, la resistencia a la corrosión.

e_{min}, e_{max}
allowable edge distances
for bolted connections, determined
for an arrangement of the contact
area outside the radius of the root
fillet and to satisfy the requirements
of EN 1993-1-8:2005 for minimum
and maximum edge distances. These
conditions are also fulfilled for bolt
diameters smaller than \emptyset . The values
are calculated considering a nominal
clearance in holes of 2mm for M10 to
M24 bolts and of 3mm for M27 bolts.

Local buckling requirements and, if
applicable, the resistance to corrosion
have to be checked.

e_{min}, e_{max}
distanze ammissibili dal bordo
per collegamenti tramite imbullonatu-
ra, determinati per garantire la super-
ficie di contatto al di fuori dal raggio
di raccordo e per soddisfare i requisiti
della normativa EN 1993-1-8:2005
sulle distanze minime e massime dal
bordo. Queste condizioni vengono
soddisfatte anche per bulloni con
diametro inferiore a \emptyset . Questi valori
sono calcolati considerando i fori con
un gioco nominale di 2 mm per bulloni
da M10 a M24 e
3 mm per bulloni M27.

Devono essere controllati i requisiti di
instabilità locale e, quando necessario,
di resistenza alla corrosione.

G masa por unidad de longitud

G mass per unit length

G massa per lunghezza unitaria

$$G = A \rho_a$$

h altura del perfil

h depth of section

h altezza del profilato

h_i altura interior entre las alas

h_i inner depth between flanges

h_i altezza interna fra le ali

$$h_i = h - 2 t_f$$

I momento de inercia de flexión

I second moment of area

I momento di inerzia a flessione

$$I_y = \frac{1}{12} [b h^3 - (b - t_w) (h - 2 t_f)^3] + 0,03 r^4 + 0,2146 r^2 (h - 2 t_f - 0,4468 r)^2$$

$$I_z = \frac{1}{12} [2 t_f b^3 + (h - 2 t_f) t_w^3] + 0,03 r^4 + 0,2146 r^2 (t_w + 0,4468 r)^2$$

i radio de giro

i radius of gyration

i raggio di inerzia

$$i_y = \sqrt{\frac{I_y}{A}}$$

$$i_z = \sqrt{\frac{I_z}{A}}$$

$$i_u = \sqrt{\frac{I_u}{A}}$$

$$i_v = \sqrt{\frac{I_v}{A}}$$

I_t momento de inercia de torsión

I_t torsion constant

I_t momento di inerzia a torsione

$$I_t = \frac{2}{3} (b - 0,63 t_f) t_f^3 + \frac{1}{3} (h - 2 t_f) t_w^3 + 2 \left(\frac{t_w}{t_f} \right) (0,145 + 0,1 \frac{r}{t_f}) \left[\frac{(r + t_w/2)^2 + (r + t_f)^2 - r^2}{2 r + t_f} \right]^4$$

I_w momento de inercia de alabeo con respecto al centro de cortadura

I_w warping constant referred to the shear centre

I_w momento di inerzia a torsione non uniforme (ingobbamento) riferito al centro di taglio

$$I_w = \frac{t_f b^3}{24} \times (h - t_f)^2$$

I_{yz} momento de inercia compuesto (momento centrífugo)

I_{yz} centrifugal moment

I_{yz} momento di inerzia composto (momento centrifugo)

P_{min} , P_{max} distancias permitidas al borde para uniones con tornillos, determinadas para garantizar una superficie de contacto por fuera del radio de acuerdo y para cumplir los requisitos de la norma EN 1993-1-8:2005 relativa a la distancia mínima y máxima con respecto al borde. El cumplimiento de estas condiciones se extiende también a tornillos con diámetros inferiores a \emptyset . Los valores se calculan teniendo en cuenta agujeros con un juego nominal de 2 mm para tornillos M10 a M24 y de 3 mm para tornillos M27.
Se considera el eje central del alma como eje de referencia para la realización de los agujeros. En caso contrario, el valor de p_{min} aplicable puede diferir ligeramente en función de las tolerancias de laminación.
Se deberá comprobar la estabilidad frente al pandeo local y, si fuera necesario, la resistencia a la corrosión.

P_{min} , P_{max} allowable edge distances for bolted connections, determined for an arrangement of the contact area outside the radius of the root fillet and to satisfy the requirements of EN 1993-1-8:2005 for minimum and maximum edge distances. These conditions are also fulfilled for bolt diameters smaller than \emptyset . The values are calculated considering a nominal clearance in holes of 2 mm for M10 to M24 bolts and of 3 mm for M27 bolts.
It is assumed that the reference axis for drilling the holes is the centre-line of the web. If not, the applicable p_{min} value may differ slightly depending on the rolling tolerances.
Local buckling requirements and, if applicable, the resistance to corrosion have to be checked.

P_{min} , P_{max} distanze ammissibili dal bordo per collegamenti tramite imbullonatura, determinati per garantire la superficie di contatto al di fuori dal raggio di raccordo e per soddisfare i requisiti della normativa EN 1993-1-8:2005 sulle distanze minime e massime dal bordo. Queste condizioni vengono soddisfatte anche per bulloni con diametro inferiore a \emptyset . Questi valori sono calcolati considerando i fori con un gioco nominale di 2 mm per bulloni da M10 a M24 e 3 mm per bulloni M27.
Si presume che l'asse di riferimento per la foratura sia l'asse dell'anima. Altrimenti, il valore p_{min} applicabile può differire leggermente a seconda delle tolleranze di laminazione.
Devono essere controllati i requisiti di instabilità locale e, quando necessario, di resistenza alla corrosione.

\emptyset diámetro máximo del tornillo

\emptyset maximum bolt diameter

\emptyset diametro massimo del bullone

r, r_1 radio de acuerdo de la unión entre el alma y el ala

r, r_1 radius of root fillet

r, r_1 raggio dell'angolo di raccordo tra anima e ala

r_2 radio de acuerdo del borde del ala

r_2 toe radius

r_2 raggio di raccordo del bordo dell'ala

ρ_a masa unitaria del acero

ρ_a unit mass of steel

ρ_a massa unitaria dell'acciaio

s_s longitud del apoyo rígido

s_s length of stiff bearing

s_s lunghezza del supporto rigido

$$s_s = t_w + 2 t_f + (4 - 2 \sqrt{2}) r$$

La longitud del apoyo rígido del ala es la distancia sobre la cual se distribuye eficazmente una carga. Este valor repercute en la resistencia a los esfuerzos transversales del alma de un perfil adyacente que carezca de elemento rigidizador.

The length of stiff bearing on the flange is the distance over which an applied force is effectively distributed. It influences the resistance of the unstiffened web of an adjacent section to transverse forces.

La lunghezza di appoggio della parte rigida sulla flangia è la distanza sulla quale una forza applicata è effettivamente distribuita. Questo valore si ripercuote sulla resistenza dell'anima di una sezione non irrigidita adiacente quando soggetta a forze trasversali.

t	espesor	t	thickness	t	spessore
t_f	espesor del ala	t_f	flange thickness	t_f	spessore della flangia
t_w	espesor del alma	t_w	web thickness	t_w	spessore dell'anima
u	distancia de la fibra extrema al eje secundario v	u	distance of extreme fibre to minor v-axis	u	distanza della fibra extrema dall'asse minore v
v	distancia de la fibra extrema al eje principal u	v	distance of extreme fibre to major u-axis	v	distanza della fibra extrema dall'asse maggiore u
V	volumen del elemento metálico por unidad de longitud	V	volume of the steel member per unit length	V	volumen dell'elemento per lunghezza unitaria
W_{el}	módulo de flexión elástica	W_{el}	elastic section modulus	W_{el}	modulo di resistenza elastico

$$W_y = \frac{2 \cdot I_y}{h} \qquad W_z = \frac{2 \cdot I_z}{b}$$

W_{pl}	módulo de flexión plástica	W_{pl}	plastic section modulus	W_{pl}	modulo di resistenza plastico
	Para un diseño plástico, la sección transversal deberá pertenecer a la clase 1 ó 2 según la capacidad de rotación necesaria.		For plastic design, the cross-section must belong to class 1 or 2 according to the required rotation capacity.		Per il metodo di calcolo plastico e a rottura la sezione trasversale deve appartenere alla classe 1 o 2, conformemente alla capacità di rotazione richiesta.

$$W_{pl,y} = \frac{t_w h^2}{4} + (b - t_w) (h - t_f) t_f + \frac{4 - \pi}{2} r^2 (h - 2 t_f) + \frac{3\pi - 10}{3} r^3$$

$$W_{pl,z} = \frac{b^2 t_f}{2} + \frac{h - 2 t_f}{4} t_w^2 + r^3 \left(\frac{10}{3} - \pi \right) + \left(2 - \frac{\pi}{2} \right) t_w \times r^2$$

Para perfiles en U: W _{pl,z} : módulo de flexión plástica referido al eje neutro plástico z' paralelo al eje z.	For channels: W _{pl,z} : plastic section modulus referred to plastic neutral z' axis which is parallel to z axis.	Per profili a U: W _{pl,z} : modulo di resistenza plastico riferito all'asse neutro z' parallelo all'asse z.
---	---	---

y_m	distancia del centro de cortadura	y_m	distance of shear centre	y_m	distanza dal centro di taglio
y_s	distancia del centro de gravedad a lo largo del eje y	y_s	distance of centre of gravity along y-axis	y_s	distanza dal centro di massa lungo l'asse y
z_s, z₁, z₂	distancia del centro de gravedad a lo largo del eje z	z_s, z₁, z₂	distance of centre of gravity along z-axis	z_s, z₁, z₂	distanza dal centro di massa lungo l'asse z

Clasificación de las secciones transversales

conforme a la norma EN 1993-1-1 2005

Classification of cross-sections

according to EN 1993-1-1 2005

Classificazione delle sezioni trasversali

conforme a EN 1993-1-1 2005

Clase 1 – Secciones transversales en las que se puede formar una rótula plástica con la capacidad de rotación necesaria para un análisis plástico.

Clase 2 – Secciones transversales en las que se puede alcanzar el momento plástico, pero con una capacidad de rotación limitada.

Clase 3 – Secciones transversales en las que la tensión calculada en la fibra más comprimida del elemento de acero puede alcanzar el límite elástico y en las que el pandeo local puede impedir alcanzar el momento plástico.

Clase 4 – Secciones transversales en las que, para determinar su resistencia al momento flector o a la compresión, es necesario tener en cuenta explícitamente los efectos locales del pandeo.

En las tablas de perfiles estructurales, se indica la clasificación de los perfiles tanto en términos de “flexión pura” sobre el eje principal y-y (alma flexionada, ala comprimida) como de “compresión pura” (alma y ala comprimidas).

Class 1 – These cross-sections can form a plastic hinge with the rotation capacity required for plastic analysis.

Class 2 – These cross-sections can develop their plastic moment resistance, but have limited rotation capacity.

Class 3 – Cross-sections of class 3 are those in which the calculated stress in the extreme compression fibre of the steel member can reach its yield strength, but local buckling is liable to prevent development of the plastic moment resistance.

Class 4 – Cross-sections of class 4 are those in which it is necessary to make explicit allowances for the effects of local buckling when determining their moment resistance or compression resistance.

In the structural shapes tables, the classification of the sections is indicated for both cases “pure bending” about strong axis y-y (web in bending, flange in compression) and “pure compression” (web and flange in compression).

Clase 1 – Queste sezioni trasversali possono formare una cerniera plastica con la capacità di rotazione richiesta per l’analisi plastica e a rottura.

Clase 2 – Queste sezioni trasversali possono sviluppare il loro momento di resistenza plastica, ma hanno una capacità di rotazione limitata.

Clase 3 – Le sezioni trasversali della classe 3 sono quelle in cui la tensione calcolata nella fibra di compressione estrema dell’elemento di acciaio può raggiungere la sua resistenza allo snervamento, ma l’instabilità locale tende a prevenire lo sviluppo del momento di resistenza plastica.

Clase 4 – Le sezioni trasversali della classe 4 sono quelle in cui è necessario evidenziare le tolleranze relative agli effetti dell’instabilità locale nel determinare la loro resistenza alla flessione ed alla compressione.

Nelle tavole dei Profili strutturali, la loro classificazione è indicata per i casi di “flessione pura” sull’asse principale y-y (anima in flessione, flangia in compressione) e “compresione pura” (anima e flangia in compressione).

Tabla 13





Tolerancias de laminación - vigas

Table 13

Rolling tolerances - beams

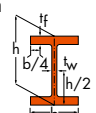
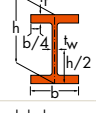
Tavola 13

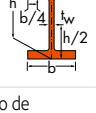
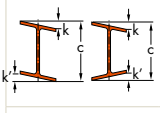
Tolleranza di laminazione - Travi

Perfiles Sections Profili	IPN J	W, HP (ASTM), HD360, HD400, HL920 HE 1000 con/ with/ con $G_{HE} > G_{HEM}$ UB 1016 con/ with/ con $G > 349 \text{ kg/m}$ HL 1000 con/ with/ con $G_{HL} > G_{HLM}$	S M	H	Perfiles fabricados a medida Tailor made sections Profili su misura						
Normas / Standards / Norma	EN 10034: 1993 ⁴⁾	EN 10024: 1995	ASTM A 6/A 6M - 07	ASTM A 6/A 6M - 07	JIS G 3192: 2005 JIS A 5526: 2005						
Altura Depth Altezza 	$h \leq 180$ $180 < h \leq 400$ $400 < h \leq 700$ $h > 700$	$\pm 3/-2$ $\pm 4/-2$ $\pm 5/-3$ $\pm 5/-5$	$h \leq 200$ $200 < h \leq 400$ $h > 400$	± 2 ± 3 ± 4	$\pm 4/-3$ $[+^1/_8 / -^1/_8]$	$75 \leq h \leq 180$ $180 < h \leq 360$ $360 < h \leq 610$ $[3 \leq h \leq 7]$ $[7 < h \leq 14]$ $[14 < h \leq 24]$	± 2 $\pm 3/-2$ $\pm 5/-3$ $[+^3/_32 / -^1/_16]$ $[+^1/_8 / -^3/_32]$ $[+^3/_16 / -^1/_8]$	$h < 400$ $400 \leq h < 600$ $h \geq 600$	± 2 ± 3 ± 4	$h \leq 180$ $180 < h \leq 400$ $400 < h \leq 700$ $h > 700$	$\pm 4/-3$ $\pm 5/-3$ $\pm 6/-4$ $\pm 6/-6$
Ancho del ala Flange width Larghezza ali 	$b \leq 110$ $110 < b \leq 210$ $210 < b \leq 325$ $b > 325$	$\pm 4/-1$ $\pm 4/-2$ $\pm 4/-4$ $\pm 6/-5$	$b \leq 75$ $75 < b \leq 100$ $100 < b \leq 125$ $b > 125$	$\pm 1,5$ ± 2 $\pm 2,5$ ± 3	$\pm 6/-5$ $[+^1/_4 / -^3/_16]$	$75 \leq h \leq 180$ $180 < h \leq 360$ $360 < h \leq 610$ $[3 \leq h \leq 7]$ $[7 < h \leq 14]$ $[14 < h \leq 24]$	± 3 ± 4 ± 5 $[+^1/_8]$ $[+^3/_32]$ $[+^3/_10]$	$b < 100$ $100 \leq b < 200$ $h \geq 200$	± 2 $\pm 2,5$ ± 3	$b \leq 110$ $110 < b \leq 210$ $210 < b \leq 325$ $b > 325$	$\pm 5/-2$ $\pm 5/-3$ $\pm 5/-5$ $\pm 7/-6$
Espesor del alma Web thickness Spessore anima 	$t_w < 7$ $7 \leq t_w < 10$ $10 \leq t_w < 20$ $20 \leq t_w < 40$ $40 \leq t_w < 60$ $t_w \geq 60$	$\pm 0,7$ ± 1 $\pm 1,5$ ± 2 $\pm 2,5$ ± 3	$t_w \leq 7$ $7 < t_w \leq 10$ $t_w > 10$	$\pm 0,5/-1$ $\pm 0,7/-$ $1,5$ $\pm 1/-2$	limitado por la tolerancia de masa limited by mass tolerance limitata dalla tolleranza di massa	$t_w < 16$ $16 \leq t_w < 25$ $25 \leq t_w < 40$ $t_w \geq 40$	$\pm 0,7$ $\pm 1,0$ $\pm 1,5$ $\pm 2,0$	$t_w < 7$ $7 \leq t_w < 10$ $10 \leq t_w < 20$ $20 \leq t_w < 40$ $40 \leq t_w < 60$ $t_w \geq 60$	$\pm 0,7$ ± 1 $\pm 1,5$ ± 2 $\pm 2,5$ ± 3		
Espesor del ala Flange thickness Spessore ali 	$t_f < 6,5$ $6,5 \leq t_f < 10$ $10 \leq t_f < 20$ $20 \leq t_f < 30$ $30 \leq t_f < 40$ $40 \leq t_f < 60$ $t_f \geq 60$	$\pm 1,5/-0,5$ $\pm 2/-1$ $\pm 2,5/-1,5$ $\pm 2,5/-2$ $\pm 2,5$ ± 3 ± 4	$t_f \leq 7$ $7 < t_f \leq 10$ $10 < t_f \leq 20$ $t_f > 20$	$\pm 1,5/-$ $0,5$ $\pm 2/-1$ $\pm 2,5/-$ $1,5$ $\pm 2,5/-2$	limitado por la tolerancia de masa limited by mass tolerance limitata dalla tolleranza di massa	$t_w < 16$ $16 \leq t_w < 25$ $25 \leq t_w < 40$ $t_w \geq 40$	$\pm 1,0$ $\pm 1,5$ $\pm 1,7$ ± 2	$t_f < 6,5$ $6,5 \leq t_f < 10$ $10 \leq t_f < 20$ $20 \leq t_f < 30$ $30 \leq t_f < 40$ $40 \leq t_f < 60$ $t_f \geq 60$	$\pm 1,5/-0,5$ $\pm 2/-1$ $\pm 2,5/-1,5$ $\pm 2,5/-2$ $\pm 2,5$ ± 3 ± 4		
Defecto de escuadra Out-of-square Fuori squadra 	$b < 110$ $b > 110$	$1,5$ $0,02 b$ (max. 6,5)	$b \leq 100$ $b > 100$	2 $0,02 b$	$h \leq 310$ $h > 310$ $[h \leq 12]$ $[h > 12]$	$k+k' \leq 6$ $k+k' \leq 8$ $[k+k' \leq ^5/_4]$ $[k+k' \leq ^5/_16]$ $c \leq h+6$ $[c \leq h+^1/_4]$	$0,03 b$ $[^1/_32 b]$	$h \leq 300$ $h > 300$	$\leq 0,01 b$ min. 1,5 mm $\leq 0,012 b$ min. 1,5 mm	$b < 110$ $b > 110$	$1,5$ $0,03 b$ (max. 8,0)
Defecto de simetría Web off-centre Anima fuori asse $e = (b_1 - b_2) / 2$ 	$t_f < 40$ $b \leq 110$ $110 < b \leq 325$ $b > 325$	$2,5$ $3,5$ 5	$b \leq 100$ $b > 100$	2 3	$G \leq 634 \text{ kg/m}$ $G > 634 \text{ kg/m}$ $[G \leq 426 \text{ lbs/ft}]$ $[G > 426 \text{ lbs/ft}]$	5 8 $[^3/_16]$ $[^5/_16]$	5 $[^3/_16]$	$h \leq 300$ $b \leq 200$ $h > 300$ $b > 200$	$\pm 2,5$ $\pm 3,5$	$t_f < 40$ $b \leq 110$ $110 < b \leq 325$ $b > 325$	$3,5$ $4,5$ 6
	$t_f \geq 40$ $110 < b \leq 325$ $b > 325$	5 8								$t_f \geq 40$ $110 < b \leq 325$ $b > 325$	6 8

Perfiles Sections Profili	IPE, IPEA, IPE O HE para/ for/ per ≤ HE 900 HE 1000 AA- M HL A, B, M, R HD260, HD 320, HP UB, UC, UBP	IPN J	W, HP (ASTM), HD360, HD400, HL920 HE 1000 con/ with/ con $G_{HE} > G_{HE M}$ UB 1016 con/ with/ con $G > 349 \text{ kg/m}$ HL 1000 con/ with/ con $G_{HL} > G_{HL M}$	S M	H	Perfiles fabricados a medida Tailor made sections Profili su misura
Normas / Standards / Norma	EN 10034: 1993 ⁴⁾	EN 10024: 1995	ASTM A 6/A 6M - 07	ASTM A 6/A 6M - 07	JIS G 3192: 2005 JIS A 5526: 2005	

Rectitud Straightness Centinatura	q_y/q_z (mm) [in.]	80<h≤180 180<h≤360 h>360	0,0030 L 0,0015 L 0,0010 L	h≤180 180<h≤360 h>360	0,0030 L 0,0015 L 0,0010 L	0,001 L ²⁾ [$1/8 \times L(\text{ft}) / 10$] ²⁾	h<75 h≥75 [h<3] [h≥3]	0,004 L 0,002 L [1/4 inch per any 5 ft] or [$1/4 \times L(\text{ft})/5$] [$1/4 \times L(\text{ft})/5$]	h≤300 h>300	≤0,0015 L ≤0,0010 L	80<h≤180 180<h≤360 h>360	0,0030 L 0,0015 L 0,0010 L
Longitud Length Lunghezza	L (mm) [in.]	-0/+100 ¹³⁾	-0/+100 ¹³⁾	-0/+100 ¹³⁾	-0/+100 ¹³⁾	-0/+100 ¹³⁾	-0/+100 ¹³⁾	-0/+100 ¹³⁾	L≤7m L>7m	+40/-0 +(40+5*(L-7))/-0	-0/+100 ³⁾	
Concavidad del alma Concavity of web Concavità dell'anima	W (mm)								b<400 400≤b<600 b≥600	2 2,5 3		
Escuadrado extremidad Sectional squareness Squadratura della sezione	e (mm)									0,016 b o/or/o 0,016 h min. 3,0 mm		
Masa/ Mass / Massa	G (%)	±4	±4	±4	±4	G<100lbs/ft: +3,0/-2,5 G≥100lbs/ft: +2,5/-2,5	±2,5	±2,5	t _r <10 t _r ≥10	±5 ±4	±4	±4

¹⁾ Cuando se especifica una longitud mínima.

²⁾ b<150: $q_{zz} \leq 0,002 L$, W200 x 200, W250 x 250, W310 x 310, W360 x 370, W360 x 410.

[b<6: $q_{zz} \leq 1/8 \times L(\text{ft})/5$, W8 x 8, W10 x 10, W12 x 12, W14 x 14,5, W14 x 16].

Si se especifica en el pedido según columnas: L≤14m: 0,001 L (máx. 10 mm), L>14 m: 10 + 0,001 * (L-14000).

[L≤45 ft: $1/8 \times L(\text{ft})/10$ (máx. 3/8), L>45 ft: $3/8 + (L(\text{ft})-45) / 10 \times$].

³⁾ Tolerancias habituales

⁴⁾ Otras tolerancias previo acuerdo

¹⁾ When a minimum length is specified.

²⁾ b<150: $q_{zz} \leq 0,002 L$, W200 x 200, W250 x 250, W310 x 310, W360 x 370, W360 x 410.

[b<6: $q_{zz} \leq 1/8 \times L(\text{ft})/5$, W8 x 8, W10 x 10, W12 x 12, W14 x 14,5, W14 x 16].

If specified on order as columns: L≤14m: 0,001 L (max. 10 mm), L>14 m: 10 + 0,001 * (L-14000).

[L≤45 ft: $1/8 \times L(\text{ft})/10$ (max. 3/8), L>45 ft: $3/8 + (L(\text{ft})-45) / 10 \times$].

³⁾ Usual tolerances.

⁴⁾ Other tolerances upon agreement.

¹⁾ Quando viene specificata una lunghezza minima.

²⁾ b<150: $q_{zz} \leq 0,002 L$, W200 x 200, W250 x 250, W310 x 310, W360 x 370, W360 x 410.

[b<6: $q_{zz} \leq 1/8 \times L(\text{ft})/5$, W8 x 8, W10 x 10, W12 x 12, W14 x 14,5, W14 x 16].

Se sono espressamente indicate come colonne nell'ordine: L≤14m: 0,001 L (max. 10 mm), L>14 m: 10 + 0,001 * (L-14000).

[L≤45 ft: $1/8 \times L(\text{ft})/10$ (max. 3/8), L>45 piedi: $3/8 + L(\text{ft})-45 / 10 \times$].

³⁾ Tolleranze tipiche.

⁴⁾ Altre tolleranze da concordare

Tabla 14 Tolerancias de las vigas alveolares



con alvéolos circulares, sinusoidales, hexagonales u octogonales

Table 14 Tolerances for castellated beams

with circular, sinusoidal, hexagonal or octagonal openings

Tavola 14 Tolleranze per travi alveolari

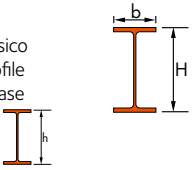
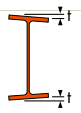
con aperture circolari, esagonali o ottagonali

	Perfil básico / Base profile / Profili base IPE				Perfil básico / Base profile / Profili base HE -HL				
	Sin placa de relleno Without fillerplate Senza piattabanda		Con placa de relleno With fillerplate Con piattabanda		Sin placa de relleno Without fillerplate Senza piattabanda		Con placa de relleno With fillerplate Con piattabanda		
Altura Depth Altezza Perfil básico Base profile Profilo base 	H (mm)	H<600	-0,6	H<600	+4/-6	H<600	+3/-5	H<600	+4/-6
		600<H<800	+4/-6	600<H<900	+5/-7	600<H<800	+4/-6	600<H<900	+5/-7
		H>800	+5/-7	H>900	+6/-8	H>800	+7/-9	H>900	+8/-10
Defecto de escuadra Out-of square Fuori squadra 	t (mm)		<0,015b		<0,015b	H<360 H>400	<0,01b <0,012b	H<400 H>450	<0,01b <0,012b
Plegado del alma Bending of web Flessione dell'anima 	f (mm)	H<600 H>600	f<4mm f<1%H	H<500 H>500	f<4mm f<1%H	H<600 H>600	f<4mm f<1%H	H<500 H>500	f<4mm f<1%H
Rectitud Straightness Rettilinearità 	q (mm)	h<360 h>360	< 0,0015 L < 0,001 L	h<360 h>360	< 0,0015 L < 0,001 L	h<360 h>360	< 0,0015 L < 0,001 L	h<360 h>360	< 0,0015 L < < 0,001 L

IPE - HE - HL	Sin placa de relleno Without fillerplate Senza piattabanda	Con placa de relleno With fillerplate Con piattabanda
Módulo /Step /Terasse: m Altura del alvéolo /Cut height/ Altezza del taglio: h Altura de la placa de relleno / Fillerplate height/ Altezza della piattabanda: h1 	m h h1	±1% ±2 2
Longitud / Length / Lunghezza Distancia entre ejes del primer alvéolo al extremo Distance between axis of first opening to end Distanza dall' estremità dell'asse della prima apertura 	L a	Corte fresado Milled cut Taglio con fresa Oxicorte Torch cut Ossitaglio ±2 -0/+100 ±5
Diferencia Gap Sfasamento 	d	<2
Desalineamiento Post alignment Disallineamento 	Δe	<2

Tabla 15



Tolerancias de laminación - Perfiles en U y viguetas

Table 15

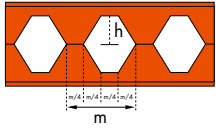
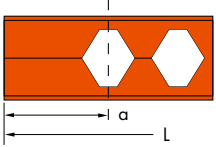
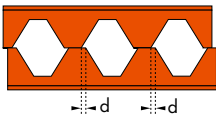
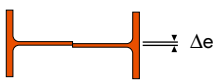
Rolling tolerances - channels & joists

Tavola 15

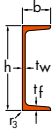
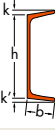
Tolleranze di laminazione – Travi

Perfiles Sections Profili		UPN, UPE, U PFC, CH		UE		C MC		
		EN 10279: 2000		GOST 8240-97		ASTM A 6/A 6M - 07		
Altura Depth Altezza		h (mm) [in]	h≤65 65<h≤200 200<h≤400 h>400	±1,5 ±2 ±3 ±4	h≤80 80<h≤200 200<h≤400	±1,5 ±2 ±3	75≤h≤180 [3≤h≤7] 180<h≤360 [7<h≤14] h>360 [h>14]	+3/-2 [+ ³ / ₃₂ /- ¹ / ₁₆] +3/-3 [+ ¹ / ₈ /- ³ / ₃₂] +5/-4 [+ ³ / ₁₆ /- ¹ / ₈]
Ancho del ala Flange width Larghezza dell'ala		b (mm) [in]	b≤50 50<b≤100 100<b≤125 b>125	±1,5 ±2 ±2,5 ±3	b≤40 40<b≤89 b>89	±1,5 ±2 ±3	75≤h≤180 [3≤h≤7] 180<h≤360 [7<h≤14] h>360 [h>14]	+3/-3 [+ ¹ / ₈ /- ¹ / ₈] +3/-4 [+ ¹ / ₈ /- ⁵ / ₃₂] +3/-5 [+ ¹ / ₈ /- ³ / ₁₆]
Espesor del alma Web thickness Spessore dell'anima		t _w (mm)	t _w ≤10 t _w >10	±0,5 ±0,7	t _w ≤5,1 5,1<t _w ≤6,0 6,0<t _w	±0,5 ±0,6 ±0,7		
Espesor del ala Flange thickness Spessore delle ali		t _f (mm)	t _f ≤10 10<t _f ≤15 15<t _f	-0,5 ²⁾ -1 ²⁾ -1,5 ²⁾	t _f ≤10 10<t _f ≤11 11<t _f	-0,5 ²⁾ -0,8 ²⁾ -1,0 ²⁾		
Radio de redondeado Heel radius Raggio di raccordo		r3 (mm)	80≤h≤400	≤0,3t _f				
Defecto de escuadra Out-of-square Fuori squadra		k (k') (mm) [in]	b≤100 b>100	k+k'≤2 k+k'≤0,025 b	b≤95 b>95	k+k'≤1,0 k+k' ≤0,015 b	k+k'≤0,03 b [k+k'≤1/32 b]	
Curvatura del alma Web deformation Deformazione dell'anima		f (mm)	h≤100 100<h≤200 200<h≤400	±0,5 ±1 ±1,5	h≤100 100<h≤200 200<h≤400	±0,5 ±1 ±1,5		
Rectitud Straightness Centinatura		q _{yy} /q _{zz} (mm) [in]	q _{yy} h≤150 150<h≤300 300<h	±0,0030 L ±0,0020 L ±0,0015 L			q _{yy} ≤0,002 L [q _{yy} ≤1/8 x L(ft)/5]	
Longitud Length Lunghezza		L (mm) [in]		-0/+100 ¹⁾³⁾ ±50			-0/+100 ¹⁾³⁾ [-0/+4] ¹⁾³⁾	
Masa / Mass / Massa		G (%)	h≤125 h>125	±6 ±4			±2,5	

¹⁾ Cuando se especifica una longitud mínima.

²⁾ Mayor desviación limitada por la tolerancia de masa.

³⁾ Tolerancias habituales.

¹⁾ When a minimum length is specified.

²⁾ Plus deviation limited by mass tolerance.

³⁾ Usual tolerances.

¹⁾ Quando viene specificata una lunghezza minima.

²⁾ Deviazione maggiore limitata dalla tolleranza di massa.

³⁾ Tolleranze tipiche.

Tabla 16

Tolerancias de laminación – barras comerciales

Table 16

Rolling tolerances - merchant bars

Tavola 16

Tolleranze di laminazione – laminati mercantili

Perfiles Sections Profili		L	L	FL Pletinas y llantas estrechas Narrow flats Piatti				
Normas / Standards / Norme		EN 10056-2: 1994	ASTM A 6/A 6M - 07	EN 10058: 2003				
Altura Depth Altezza Ancho de ala Flange width Larghezza dell'ala		h (mm) [in]	$h \leq 50$ $50 < h \leq 100$ $100 < h \leq 150$ $150 < h \leq 200$	± 1 ± 2 ± 3 ± 4	$h > 150$ [h>6]	$+5/-3$ [+3/16 / -1/8]	$10 \leq b \leq 40$ $40 < b \leq 80$ $80 < b \leq 100$ $100 < b \leq 120$ $120 < b \leq 150$	$\pm 0,75$ ± 1 $\pm 1,5$ ± 2 $\pm 2,5$
Espesor de alma / Diámetro Web thickness / Diameter Spessore dell'anima / Diametro		t_w (mm)	$t \leq 5$ $5 < t \leq 10$ $10 < t \leq 15$ $t > 15$	$\pm 0,5$ $\pm 0,75$ ± 1 $\pm 1,2$			$t \leq 20$ $20 < t \leq 40$ $40 < t \leq 80$	$\pm 0,5$ ± 1 $\pm 1,5$
Espesor del ala Flange thickness Spessore dell'ala		t_f (mm)						
Radio de redondeado Heel radius Raggio di raccordo		r_3 (mm)						
Defecto de escuadra Out-of-square Fuori squadra		k (k') (mm) [in]	$h \leq 100$ $100 < h \leq 150$ $150 < h \leq 200$	1 1,5 2	$0,026 h$ [3/128 h]	$10 < t \leq 25$ $25 < t \leq 40$ $40 < t \leq 80$	$\pm 0,5$ ± 1 $\pm 1,5$	
Simetría Symmetry Simmetria		e						

FL Pletinas y llantas Wide flats Larghi piatti	SQ Barras cuadradas Square shapes Angolari	R Barras redondas de acero laminadas en caliente Round bars Tondi laminati a caldo	T Perfil en T de alas iguales Equal flange tees Profilo T ad ali uguali
EU 91-81	EN 10059: 2003	EN 10060: 2003	EN 10055: 1995

							$b \leq 50$ $50 < b \leq 80$	$\pm 1,0$ $\pm 1,5$
$b \leq 500$	$\pm 0,02 b$	$b \leq 50$ $b \leq 80$ $b \leq 100$ $b \leq 120$ $b \leq 160$	$\pm 0,8$ ± 1 $\pm 1,3$ $\pm 1,5$ ± 2				$b \leq 50$ $50 < b \leq 80$	$\pm 1,0$ $\pm 1,5$
T I $10 \leq t < 20$ $20 \leq t < 25$ $25 \leq t < 30$ $30 \leq t < 40$ $40 \leq t < 50$ $50 \leq t < 60$ $60 \leq t < 80$ $t \geq 80$ T II $10 \leq t < 20$ $20 \leq t < 25$ $25 \leq t < 30$ $30 \leq t < 40$ $40 \leq t < 50$ $50 \leq t < 60$ $60 \leq t < 80$ $t \geq 80$ $150 < b \leq 400$	$+0,8/-0,4$ $+0,9/-0,5$ $+1/-0,6$ $+1,1/-0,7$ $+1,1/-0,9$ $+1,2/-1,0$ $+1,6/-1,0$ $+3,0/-1,0$ $\pm 0,6$ $\pm 0,7$ $\pm 0,8$ $\pm 0,9$ $\pm 1,0$ $\pm 1,1$ $\pm 1,3$ $\pm 2,0$ max. $\Delta tb = 0,5$			$10 \leq t \leq 15$ $15 < t \leq 25$ $25 < t \leq 35$ $35 < t \leq 50$ $50 < t \leq 80$ $80 < t \leq 100$ $100 < t \leq 120$	$\pm 0,4$ $\pm 0,5$ $\pm 0,6$ $\pm 0,8$ $\pm 1,0$ $\pm 1,3$ $\pm 1,5$		$b \leq 50$ $50 < b \leq 80$	$\pm 0,5$ $\pm 0,75$
							$b \leq 50$ $50 < b \leq 80$	$\pm 0,5$ $\pm 0,75$
		$30 < b \leq 50$ $50 < b \leq 100$ $b > 100$	$\leq 2,5$ ≤ 3 ≤ 4					
	± 5	$t \leq 50$ $50 < t \leq 75$ $75 < t \leq 100$ $100 < t \leq 150$	$\pm 1,5$ $\pm 2,25$ $\pm 3,0$ $\pm 4,5$				$b, h \leq 100$ $100 < b, h$	$k \leq 1$ $k \leq 1,5$
							$b \leq 60$ $60 < b$	$e \leq 1$ $e \leq 1,5$

Tabla 16

Tolerancias de laminación – barras comerciales (continúa)

Table 16

Rolling tolerances - merchant bars (continued)

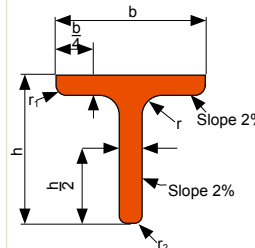
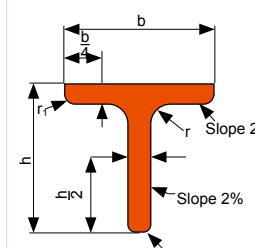
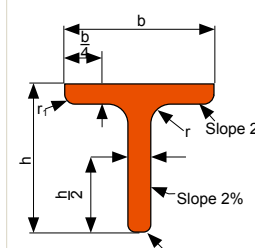
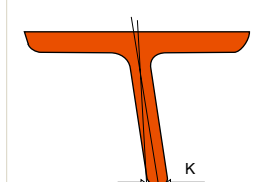
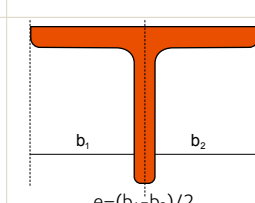
Tavola 16

Tolleranze di laminazione – laminati mercantili (continua)

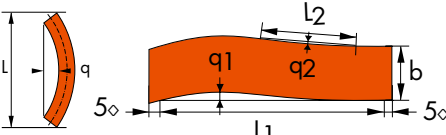
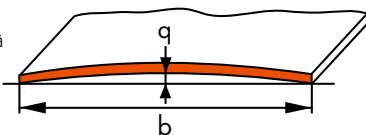
Perfiles Sections Profili		L		L		FL Pletinas y llantas estrechas Narrow flats Piatti
Normas / Standards / Norme		EN 10056-2: 1994		ASTM A 6/A 6M - 07		EN 10058: 2003
Perfil con aristas vivas Sharpness Profilo a spigoli vivi	w (mm)					
Rectitud Straightness Rettilineità	 q_{yy}/q_{zz} (mm) [in]	$h \leq 150$ $150 < h \leq 200$	$0,004 L$ $0,002 L$	$h < 75$ $[h < 3]$	$q_{yy} \leq 0,004 L$ $[q_{yy} \leq 1/4 \text{ inch}$ per any 5ft or $1/4 \times L \text{ (ft)/5}]$ $q_{yy} \leq 0,002 L$ $[q_{yy} \leq 1/8 \times L$ $\text{(ft)/5}]$	$bxt < 1000\text{mm}^2$ $q \leq 0,0040 L$ $bxt \geq 1000\text{mm}^2$ $q \leq 0,0025 L$ en el plano de b in the plane of b nel piano di b
Planidad Flatness Planarità	 q (mm)					
Longitud Length Lunghezza	L (mm) [in]		$-0/+100^{(1)(4)}$ ± 50		$-0/+100^{(1)(4)}$ $[-0/+4]$	± 100
Masa Mass Massa	G (%)	$t \leq 4$ $t > 4$	± 6 ± 4		$h \geq 75$ $[h \geq 3]$	$\pm 2,5$

FL Pletinas y llantas Wide flats Larghi piatti	SQ Barras cuadradas Square shapes Angolari	R Barras redondas de acero laminadas en caliente Round bars Tondi laminati a caldo	T Perfil en T de alas iguales Equal flange tees Profilo T ad ali uguali
EU 91-81	EN 10059: 2003	EN 10060: 2003	EN 10055: 1995

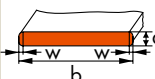
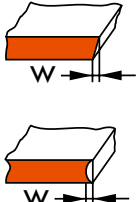
$t \leq 13$ $13 < t \leq 18$ $t > 18$	≤ 2 ≤ 3 $\leq 3,5$						
							
$L_1 q_1 \leq 0,0025 L_1$		$25 < b \leq 80$ $80 < b$	$0,0040 L$ $0,0025 L$			$50 \leq b, h \leq 80$	$q \leq 0,4\%$ of L
$L_2 \geq 1000$	$q_2 \leq 0,0025 L_2$						
transv. $\pm 0,003b$ longit.							
$L = 1000$ $500 \leq L$ < 1000 $\leq L$	± 7 $\pm 0,007 L$ ± 20						
-0/+200						Normal tolerances	± 100
T I < 5000 kg ≥ 5000 kg > 15000 kg T II < 5000 kg ≥ 5000 kg > 15000 kg	$+8/-4$ $+8/-2$ $+6/-2$ ± 6 ± 5 ± 4	± 4				$4 \leq s, t \leq 7$ $7 < s, t$	- 8% - 6%

- 1) Cuando se especifica una longitud mínima.
2) Mayor desviación limitada por la tolerancia de masa.
3) L' = longitud considerada en cualquier parte.
4) Tolerancias habituales.

- 1) When a minimum length is specified.
2) Plus deviation limited by mass tolerance.
3) L' = length considered over any part.
4) Usual tolerances.

- 1) Quando viene specificata una lunghezza minima.
2) Deviazione maggiore dalla tolleranza di massa.
3) L' = lunghezza considerata in una parte qualsiasi.
4) Tolleranze tipiche.

Tabla de conversión

Conversion table

Tavole di conversione

Longitud/Área/Volumen	Length/Area/Volume	Lunghezza / Area / Volume
1 mm	= 0,03937 in	1 in (inch) = 25,4 mm
1 cm	= 0,393701 in	1 in (inch) = 2,54 cm
1 m	= 3,281 ft	1 ft (foot) = 0,3048 m
1 cm ²	= 0,1550 in ²	1 in ² = 6,452 cm ²
1 m ²	= 10,76 ft ²	1 ft ² = 0,0929 m ²
1 cm ³	= 0,06102 in ³	1 in ³ = 16,390 cm ³
1 m ³	= 35,31 ft ³	1 ft ³ = 0,02832 m ³
1 cm ⁴	= 0,02403 in ⁴	1 in ⁴ = 41,62 cm ⁴

Fuerza/Tensión	Force/Stress	Forza / Carico
1 N	= 0,2248 lbf	1 lbf (pound-force) = 4,448 N
1 N/m	= 0,06852 lbf/ft	1 lbf/ft = 14,59 N/m
1 N/mm ² = 1 MPa	= 145 lbf/in ²	1 lbf/in ² (psi) = 0,006895 N/mm ²
1 N/mm ² = 1 MPa	= 0,145 ksi	1 ksi = 6,895 N/mm ²
1 N/cm ²	= 1,45 lbf/in ²	1 lbf/in ² = 0,6895 N/cm ²

Momento	Moment	Momento
1 N m	= 8,851 lbf – in	1 lbf – in = 0,113 N m
1 N m	= 0,7376 lbf – ft	1 lbf – ft = 1,356 N m

Masa	Mass	Massa
kg	= 2,205 lb	1 lb (pound-mass) = 0,4536 kg
1 tonne (metric)	= 1,102 short ton (2000 lb.)	1 short ton = 0,9072 tonne (metric)
1 tonne (metric)	= 0,9842 long ton (2240 lb.)	1 long ton = 1,016 tonne (metric)
1 kg/m	= 0,672 lb/ft	1 lb/ft = 1,4882 kg/m

Temperatura	Temperature	Temperatura
°C (Celsius)	= (°F – 32)/1,8	°F (Fahrenheit) = (1,8 x °C) + 32

Energía	Energy	Energia
1 J (Joule)	= 0,737562 ft-lbf	1 ft-lbf = 1,355818 J

Coeficientes materiales del acero estructural

Material coefficients of structural steel

Proprietà dell'acciaio da costruzione

α_a coeficiente de dilatación térmica

α_a coefficient of linear thermal expansion

α_a coefficiente di dilatazione termica lineare

$$\alpha_a = 12 \cdot 10^{-6} \text{ K}^{-1}$$

E_a módulo de elasticidad

E_a modulus of elasticity

E_a modulo elastico

$$E_a = 210000 \text{ N/mm}^2 = 210000 \text{ MPa} = 210 \text{ kN/mm}^2 = 21000 \text{ kN/cm}^2 = 210000 \text{ MN/m}^2$$

G_a módulo de cortadura

G_a shear modulus

G_a modulo di torsione

$$G_a = \frac{E_a}{2(1 + \nu_a)}$$

$$G_a \cong 81000 \text{ N/mm}^2 = 81000 \text{ MPa} = 81 \text{ kN/mm}^2 = 8100 \text{ kN/cm}^2 = 81000 \text{ MN/m}^2$$

ν_a coeficiente de Poisson

ν_a Poisson's ratio

ν_a coefficiente di Poisson

$$\nu_a = 0,3$$

ρ_a masa unitaria

ρ_a unit mass

ρ_a massa unitaria

$$\rho_a = 7850 \text{ kg/m}^3$$



Datos comerciales y agencias

216 Condiciones de suministro

218 Soporte técnico

219 Building & Construction Support

220 Acabado

221 Investigación y desarrollo

222 Nuestras agencias

Commercial data and agencies

216 Delivery conditions

218 Technical support

219 Building & Construction Support

220 Finishing

221 Research and development

222 Our agencies

Dati commerciali e consulenza

216 Condizioni di fornitura

218 Assistenza tecnica

219 Building & Construction Support

220 Finitura

221 Ricerca e sviluppo

222 I nostri agenti

Condiciones de suministro

Tolerancias de laminación

En la Tabla 11-14 se incluyen las tolerancias de laminación habituales en dimensiones, forma, peso y longitud. Es posible reducir tolerancias específicas previo acuerdo.

Longitud máxima disponible

La longitud máxima fluctúa entre 18,1 y 33 m, dependiendo de la forma. Es posible suministrar longitudes superiores únicamente previa consulta.

Pedido mínimo

Salvo que se indique lo contrario en las tablas de perfiles, el pedido mínimo es de 5 toneladas por perfil, calidad, longitud y destino.

Estado de la superficie

El material se suministra en condiciones estándar de fábrica, cumpliendo su calidad superficial la norma EN10163-3: 2004, clase C, subclase 1.

El control por ultrasonidos

El control por ultrasonidos se realiza previo acuerdo y supone un coste adicional. El comprador y el fabricante deben acordar entre sí el procedimiento para realizar este control.

Certificación

El calidad de certificación deberá especificarse en el momento de realizar el pedido.

Plazo de entrega

Rogamos contacten con nuestro representante local.

Delivery conditions

Rolling tolerances

The usual rolling tolerances on dimensions, shape, weight and length are given in table 11-14. Specific tolerances can be reduced after agreement.

Maximum length available

The maximum length varies between 18,1 and 33 m depending on the shape. Greater lengths are available only upon request.

Minimum tonnage

Unless otherwise indicated in the section tables, the minimum tonnage for any order is 5 tonnes per section, quality, length and destination.

Surface conditioning

Material is delivered in standard ex-mill condition with surface quality in accordance with EN10163-3: 2004, class C, subclass 1.

Ultrasonic testing

Ultrasonic testing is carried out upon agreement at extra cost. The procedure for this test must be agreed between the purchaser and the manufacturer.

Certification

The type of certification shall be specified at the time of order.

Terms of delivery

Please contact our local representative.

Condizioni di fornitura

Tolleranze di laminazione

Le tolleranze di laminazione usuali relative a dimensioni, forma, peso e lunghezza sono evidenziate nella tavola 11-14. Tolleranze specifiche possono essere ridotte previo accordo.

Massime lunghezze disponibili

La lunghezza massima varia tra 18,1 e 33 m a seconda della forma. Lunghezze maggiori sono disponibili su richiesta.

Tonnellaggio minimo

A meno che non sia indicato diversamente nelle tavole dei profili, il tonnellaggio minimo per ciascun ordine è di 5 tonnellate per profilo, qualità, lunghezza e destinazione.

Condizioni di superficie

Il materiale è fornito con le condizioni standard di produzione con qualità della superficie in conformità con la regolamentazione EN 10163-3: 2004, classe C, sottoclasse 1.

Il collaudo con ultrasuoni

Il collaudo con ultrasuoni viene effettuato su richiesta ad un costo extra. La procedura da seguire per tale collaudo deve essere concordata tra l'acquirente ed il produttore.

Certificazione

La qualità di certificazione verrà specificato all'atto dell'ordine.

Termini di fornitura

Vi preghiamo di prendere contatti col nostro rappresentante locale.

Condiciones generales de suministro

Salvo que se indique lo contrario, las condiciones generales de suministro cumplen las especificaciones de la norma EN 10021: 1993. El documento está disponible previa solicitud o en la página web www.arcelormittal.com/sections.

Aseguramiento de calidad

Las fábricas donde se producen los perfiles y las barras comerciales de la división Commercial Sections de ArcelorMittal están certificadas ISO 9001.

Desde el primero de septiembre de 2006, indicamos en el documento de control la marca CE así como las demás informaciones requeridas en la parte 1 armonizada – anexo ZA de EN 10025:2004 para todos nuestros productos suministrados en calidades de acero conforme a esta nueva norma europea. La marca CE sustituye a toda marca nacional de conformidad europea que tenga el mismo campo de aplicación.

Perfiles fabricados a medida

A partir de ciertas series de perfiles estándar, estamos en posición de ofrecer al constructor una gama completa de perfiles derivados: perfiles fabricados a medida. El usuario puede así determinar por sí mismo el perfil que desea y hacerlo laminar a medida. Gracias a nuestra técnica universal de laminación, la fabricación resulta eficaz y económica. El pedido de perfiles a medida está sujeto a un peso mínimo de 500 toneladas por perfil y calidad.

General delivery conditions

If not otherwise specified, general delivery conditions are in accordance with EN10021: 1993. The document is available upon request and can be found on the Internet site www.arcelormittal.com/sections.

Quality Assurance

The mills producing the sections and merchant bars of the Commercial Sections division of ArcelorMittal are certified ISO 9001.

Since September 1, 2006, the CE mark and the other information required in the harmonized part 1 – annex ZA of EN 10025:2004 are shown in the inspection document for all our products that are delivered in steel grades according to this new European standard. The CE marking replaces any national European conformity marking having the same scope.

Tailor-made beams

Working from the basis of specific standard beam ranges, we can offer the constructor a whole range of derived sections : tailor-made beams. The user can establish the steel section that is needed and have it rolled to measure. With our universal rolling technique, manufacture is both efficient and economic. The minimum order per tailor-made section and grade is 500 tonnes.

Condizioni generali di fornitura

Se non altrimenti specificato, le condizioni generali di fornitura sono in conformità alla normativa EN 10021: 1993. Il documento è disponibile su richiesta e può essere reperito sul sito Internet www.arcelormittal.com/sections.

Assicurazione qualità

Gli stabilimenti che producono i profili commerciali della divisione ArcelorMittal Comercial Sections sono certificati ISO 9001.

Dal 1° settembre 2006 il marchio CE e altre informazioni richieste nella parte 1 – annesso ZA di EN 10025:2004 per l'armonizzazione, sono indicate nel documento di ispezione per tutti i nostri prodotti forniti in qualità contemplate dai nuovi standard europei. Il marchio CE sostituisce tutti i marchi di conformità nazionali europei aventi lo stesso scopo.

Sezioni su misura

Partendo da una gamma di Sezioni standard, possiamo offrire al costruttore una serie completa di profili derivati: Sezioni su misura. Il cliente stesso può stabilire il profilo in acciaio che desidera, che verrà laminato su misura. Grazie alle nostre tecniche universali di laminazione, la fabbricazione risulta efficiente ed al tempo stesso economica. L'ordine minimo per profilo su misura e qualità è di 500 tonnellate.

Soporte técnico

Nos complace ofrecerle asesoramiento técnico gratuito para optimizar el uso de nuestros productos y soluciones en sus proyectos y responder a todas sus preguntas sobre el uso de perfiles y barras comerciales. Este asesoramiento técnico abarca el diseño de elementos estructurales, los detalles de construcción, la protección de las superficies, la protección contra incendios, la metalurgia y la soldadura. Nuestros especialistas están a su disposición para acompañar sus iniciativas en cualquier parte del planeta. Para facilitar el diseño de sus proyectos, ofrecemos igualmente software y documentación técnica que puede consultar o bajar desde nuestra página web

www.arcelormittal.com/sections

Technical support

We are happy to provide you with free technical advice to optimise the use of our products and solutions in your projects and to answer your questions about the use of sections and merchant bars. This technical advice covers the design of structural elements, construction details, surface protection, fire safety, metallurgy and welding. Our specialists are ready to support your initiatives anywhere in the world. To facilitate the design of your projects, we also offer software and technical documentation that you can consult or download from our website

www.arcelormittal.com/sections

Assistenza tecnica

Siamo disponibili a consigliarvi gratuitamente allo scopo di ottimizzare l'uso dei nostri prodotti per i vostri progetti ed a rispondere a domande circa l'uso dei profili e dei laminati mercantili. Questa consulenza riguarda il progetto di elementi strutturali, i dettagli costruttivi, la protezione di superficie, sicurezza antincendio, metallurgia e saldatura. I nostri specialisti sono preparati a seguire le vostre iniziative in tutto il mondo. Come supporto ai vostri progetti sono disponibili software e documentazione tecnica che potete consultare o scaricare dal nostro sito

www.arcelormittal.com/sections

Building & Construction Support

En ArcelorMittal contamos también con un equipo de profesionales multiproductos especializado en el mercado de la construcción: la división Building & Construction Support (BCS).

Una gama completa de productos y soluciones dedicados a la construcción en todas sus formas: estructuras, fachadas, cubiertas, etc. está disponible en nuestra página web

www.arcelormittal.com/constructalia

Building & Construction Support

At ArcelorMittal we also have a team of multi-product professionals specialising in the construction market: the Building & Construction Support (BCS) division.

A complete range of products and solutions dedicated to construction in all its forms: structures, façades, roofing, etc. is available from the website

www.arcelormittal.com/constructalia

Building & Construction Support

In ArcelorMittal è presente un team di professionisti specializzati nel campo delle costruzioni: la divisione Building & Construction Support (BCS).

Una gamma completa di prodotti e soluzioni dedicate al settore delle costruzioni in tutte le sue forme: strutture, facciate, coperture, ecc, sono disponibili dal sito web

www.arcelormittal.com/constructalia

Acabado

Para completar las posibilidades técnicas de nuestros interlocutores, nos hemos dotado de potentes herramientas de acabado y ofrecemos una amplia gama de servicios, tales como:

- taladrado
- oxicorte
- recorte en T
- entallado
- combado
- curvado
- enderezado
- aserrado en frío a la longitud exacta
- soldadura de conectores
- granallado
- tratamiento superficial

Finishing

As a complement to the technical capacities of our partners, we are equipped with high-performance finishing tools and offer a wide range of services, such as:

- drilling
- flame cutting
- T cut-outs
- notching
- cambering
- curving
- straightening
- cold sawing to exact length
- welding and fitting of studs
- shot and sand blasting
- surface treatment

Finitura

A completezza delle capacità tecniche dei nostri partners, siamo dotati di macchine per finiture di alta qualità che offrono una vasta gamma di servizi, come:

- foratura
- taglio a fiamma ossidrica
- Tagli a T
- dentellatura
- centinatura
- curvatura
- raddrizzamento
- taglio a freddo a lunghezza precisa
- saldatura e fissaggio bulloni
- sabbiatura e impallinatura
- trattamento di superficie

Investigación y desarrollo

ArcelorMittal desarrolla constantemente nuevos productos y soluciones innovadoras para adaptarse a las necesidades específicas del mercado de la construcción.

La protección contra incendios, el desarrollo sostenible, los revestimientos, la construcción mixta y el uso de los Eurocódigos forman parte integrante de nuestra estrategia.

Nuestro centro de investigación, en colaboración con la dirección de las ventas y del marketing, realiza además guías y software de utilización de productos, y se encarga de su distribución en sinergia con los organismos técnicos y de promoción europeos, así como con empresas de edición de software especializado en la construcción, reconocidas mundialmente.

Consulte www.access-steel.com para aprender a utilizar con facilidad los Eurocódigos, y www.securewithsteel.com para saber más sobre la red europea de especialistas en ingeniería de prevención de incendios.

Research and development

ArcelorMittal is constantly developing innovative products and solutions designed to satisfy the specific needs of the construction market.

Fire safety, sustainable development, coatings, composite construction and the use of the Eurocodes form an integral part of our strategy.

And our research centre, working with sales and marketing management, also produces product user guides and software, and takes care of the distribution of its output in synergy with European technical and promotional units, as well as globally recognized software publishers specialising in the construction industry.

Visit www.access-steel.com to learn how to use the Eurocodes with ease, and www.securewithsteel.com to find out about the European network of fire safety engineering specialists.

Ricerca e sviluppo

ArcelorMittal sviluppa costantemente prodotti innovativi e soluzioni atte a soddisfare necessità specifiche del mercato edilizio.

La sicurezza antincendio, lo sviluppo sostenibile, i rivestimenti, le costruzioni composte e l'applicazione degli Eurocodici formano parte integrante della nostra strategia.

Il nostro centro di ricerca, in cooperazione con la direzione di vendite e marketing, produce anche manuali di guida per il cliente e si cura della loro diffusione in sinergia con le unità di sviluppo tecnico europee. Pubblica anche software riconosciuto in tutto il mondo rivolto all'industria edilizia.

Visitate il sito www.access-steel.com per imparare ad usare gli Eurocodici con facilità e www.securewithsteel.com per trovare la rete di specialisti europei per le misure antincendio.

Nuestras agencias Our agencies I nostri agenti

ARCELORMITTAL COMMERCIAL SECTIONS

Sede social
Headquarters
Direzione Generale

LUXEMBOURG

ArcelorMittal
Commercial Sections
66, rue de Luxembourg
L-4221 Esch-sur-Alzette
LUXEMBOURG
T : +352 5313 3014
F : +352 5313 3089
sections.sales@arcelormittal.com

SPAIN

ArcelorMittal
Comercial Perfiles Espana S.L.
Ctr. Toledo. Km. 9,200
E-28021 Madrid
SPAIN
T : +34 91 797 23 00
F : +34 91 795 31 81

Agencias comerciales
Sales agencies
I nostri Agenti

AUSTRIA

ArcelorMittal
Commercial Sections - Austria GmbH
Vogelweiderstraße 66
A-5020 Salzburg
AUSTRIA
T : +43 662 88 67 44
F : +43 662 88 67 44 10
sections.austria@arcelormittal.com

BELGIUM - THE NETHERLANDS

ArcelorMittal
Commercial Sections Benelux B.V.
Boompjes 40
NL-3011 XB Rotterdam
P.O. Box 2606
NL-3000 CP Rotterdam
THE NETHERLANDS
T : +31 10 20 60 555
F : +31 10 20 60 559
sections.benelux@arcelormittal.com

FRANCE

ArcelorMittal
Commercial Sections France S.A.
5, rue Luigi Cherubini
F-93212 La Plaine Saint Denis Cedex
FRANCE
T : +33 1 71 92 00 00
F : +33 1 71 92 17 97
sections.france@arcelormittal.com

Domaine de Pelus
4, rue Graham Bell
F-33700 Merignac
FRANCE
T : +33 5 57 92 09 10
F : +33 5 57 92 61 92
jf.bardyn@arcelormittal.com

UNITED KINGDOM AND IRELAND

ArcelorMittal
Commercial Sections UK Ltd
Arcelor House
4 Prince's Way Solihull
West Midlands B91 3AL
UNITED KINGDOM
T : +44 121 705 84 44
F : +44 121 703 05 85
sections.uk@arcelormittal.com

69 High Street, Rayleigh
Essex S56 7EJ
UNITED KINGDOM
T : +44 126 877 90 56
F : +44 126 877 84 79
sections.uk@arcelormittal.com

GREECE AND CYPRUS

ArcelorMittal
Commercial FCSE Greece Ltd.
Zeppou 51
GR-16675 Glyfada Athens
GREECE
T : +30 210 960 42 79
F : +30 210 965 25 88
sections.greece@arcelormittal.com

GERMANY

ArcelorMittal
Commercial Sections Deutschland GmbH
Subbelrather Straße 13
D-50672 Köln
P.O. Box 10 12 04
D-50452 Köln
GERMANY
T : +49 221 572 90
F : +49 221 572 92 65
sections.deutschland@arcelormittal.com

Augustenstraße 14
D-70178 Stuttgart
GERMANY
T : +49 711 667 40
F : +49 711 667 42 80
michael.buerkle@arcelormittal.com

ICELAND

ArcelorMittal
Gudmundur Arason EHF
Skútuvogur 4
IS-104 Reykjavik
ICELAND
T : +354 568 6844
F : +354 568 0585
Kari@ga.is

ITALY

ArcelorMittal
Commercial Sections Italia Srl
Strada Torino 43 c/o
Europalace Center
I-10043 Orbassano (TO)
ITALY
T : +39 011 906 3931
F : +39 011 903 5850
sections.italia@arcelormittal.com

SWITZERLAND

ArcelorMittal
Commercial Sections Schweiz AG
Innere Margarethenstrasse 7
CH-4051 Basel
SWITZERLAND
T : +41 61 227 77 77
F : +41 61 227 77 66
sections.switzerland@arcelormittal.com

DENMARK

ArcelorMittal
Commercial Long Denmark A/S
Islands Brygge, 43
DK-2300 Copenhagen
DENMARK
T : +45 33 74 17 11
F : +45 33 13 10 93
sections.denmark@arcelormittal.com

FINLAND

ArcelorMittal
Commercial Long Finland OY
Yrjönkatu 9A3
FIN-00120 Helsinki
FINLAND
T : +358 9 74 222 400
F : +358 9 74 222 450
sections.finland@arcelormittal.com

NORWAY

ArcelorMittal
Commercial Long Norway A/S
Arbinsgate 2,
N-0253 Oslo
Postboks 2667 Solli,
N-0203 Oslo
NORWAY
T : +47 22 83 78 20
F : +47 22 83 78 21
sections.norway@arcelormittal.com

SWEDEN

ArcelorMittal
Commercial Long Sweden A.B.
Birger Jarlsgatan 41 A
S-111 45 Stockholm
SWEDEN
T : +46 8 534 80 94 0
F : +46 8 611 61 55
sections.sweden@arcelormittal.com

CZECH REPUBLIC

ArcelorMittal
Commercial Long Czech
Vratimovska 689
CZ - 707 02 Ostrava Kuncice
CZECH REPUBLIC
T : +420 595 686 024
F : +420 595 684 232
sections.czechrepublic@arcelormittal.com

POLAND

ArcelorMittal
Commercial Long Polska
ul. J. Pilsudskiego 92
PL-41-303 Dabrowa Gornicza
POLAND
T : +48 32 776 67 27
F : +48 32 776 81 50
sections.poland@arcelormittal.com

TURKEY

ArcelorMittal
Commercial Long
çelik Dis Ticaret A.S.
Nispetiye Caddesi, N° 22
Ozden Is Merkezi, Kat 2
Levent 34330 Istanbul
TURKEY
T : +90 212 317 49 90
F : +90 212 278 9485
sections.turkey@arcelormittal.com

ROMANIA

ArcelorMittal
Commercial Long Romania S.R.L.
7-9 Intrarea Tudor Stefan
2nd Floor, AP4,
Sector 1, 01 1655 Bucharest
ROMANIA
T : +40 31 405 47 93
F : +40 21 231 71 38
sections.romania@arcelormittal.com

ARCELORMITTAL INTERNATIONAL TRADING & SALES

Sede social
Headquarters
Direzione Generale

LUXEMBOURG

ArcelorMittal
International Trading & Sales
19, avenue de la Liberté
L-2930 Luxembourg
LUXEMBOURG
T : +352 4792 1
F : +352 49 07 49
international@arcelormittal.com

AFRICA

ArcelorMittal
International Trading & Sales
Douar Chtaiba, Route 107 – Tit Mellil
Casablanca
MOROCCO
T : +212-22-75 17 25
F : +212-22-75 17 43
ai-africa@arcelormittal.com

ALGERIA

ArcelorMittal
International Trading & Sales
World Trade Center
70, Chemin Larbi Allik
BP 539 HYDRA
Alger (site Trust)
ALGERIA
T : +213 21 54 86 56
F : +213 21 54 86 55
ai-algerie@arcelormittal.com

BRAZIL

ArcelorMittal
International Trading & Sales
Alameda Rio Negro 1030 – 14 floor – Conj. 1402
Edifício Stadium – Corporate Tower
Alphaville – Barueri
Sao Paulo – CEP NR. 06454-000
BRAZIL
T : +55 11 4195 65 21
F : +55 11 4193 62 11
ai-brazil@arcelor.com

CHILE

ArcelorMittal
International Trading & Sales
San Pio X N° 2460 Of. 705.
Providencia/Santiago
CHILE
T : +56-2-233 96 94
F : +56-2-233 26 80
ai-chile@arcelormittal.com

CHINA (PEOPLE'S REPUBLIC OF)

ArcelorMittal
International Trading & Sales
Unit A2 -13F Time Square,500 Zhangyang Road
Pudong, Shanghai 200122
P.R. CHINA
T : +86-21-58368200
F : +86-21-58368107
ai-china@arcelor.com

ArcelorMittal
International Trading & Sales
Fortune Plaza Office Tower A, Room 3801
7 Dongsanhuan Zhong Lu Chaoyang District
100020 Beijing
P.R. CHINA
T : +86-10-65309633
F : +86-10-65309884
ai-beijing@arcelormittal.com

ArcelorMittal
International Trading & Sales
Room 1601, 16/F, Tower 1, China
Hong Kong City, 33 Canton Road
Tsimshatsiu, Kowloon, Hong Kong,
P.R. CHINA
T : +852-2522 4123
F : +852-2521 7905
ai-hongkong@arcelor.com

COLOMBIA

ArcelorMittal
International Trading & Sales
Calle 90 N° 12-45 Of. 605
Santafe De Bogota,
COLOMBIA
T : +57-1-623 40 22
F : +57-1-610 01 73
ai-colombia@arcelormittal.com

CUBA

ArcelorMittal
International Trading & Sales
Avenida 5ta
Edificio Santiago de Cuba, Piso N°. 2
Miramar, Municipio Playa
Ciudad de La Habana,
CUBA

ECUADOR

ArcelorMittal
International Trading & Sales
Av. Pampite S/N y Chimborazo
Centro Comercial La Esquina, Oficina 3
Cumbayá
Quito,
ECUADOR
T : + 593-2-289 2162 / 2163 / 2164
F : +593-2-289 4071
ai-ecuador@arcelormittal.com

INDIA

ArcelorMittal
International Trading & Sales
World Trade Centre, Flat 429, 4th floor, Babar Road
New-Delhi – 110 001,
INDIA
T : +91-11-2341 46 63
F : +91-11-2341 46 70
ai-india@arcelor.com

INDONESIA

ArcelorMittal
International Trading & Sales
Graha Iskandarsyah Building, 6th floor
Jalan Iskandarsyah Raya N° 66C
Kebayoran Baru, Jakarta Selatan – 12160,
INDONESIA
T : +62-21-7278 3706
F : +62-21-7278 3707
ai-indonesia@arcelormittal.com

IRAN (ISLAMIC REPUBLIC OF)

ArcelorMittal
International Trading & Sales
Fereshteh Street, Maryam Street N°58
Unit N° 17, First floor
Post code: 1964966345
Teheran
I. R. IRAN
T : +98-21-22050 523
F : +98-21-22050 334
ai-iran@arcelormittal.com

JAPAN

ArcelorMittal
International Trading & Sales
DIK Kojimachi Bldg. 6th Fl.
1-6-9, Kojimachi, Chiyoda-ku,
Tokyo 102-0083
JAPAN
T : +81-03-3221 0368
F : +81-03-3221 0369
ai-japan@arcelormittal.com

KOREA

ArcelorMittal
International Trading & Sales
B-613 kolon tripolis 1, Gumgok-
dong Bundang-gu, Sungnam city
Kyunggi-do, Post Code 463804
KOREA
T : +82-31-715 3242
F : +82-31-715 3243
ai-korea@arcelormittal.com

MALAYSIA

ArcelorMittal
International Trading & Sales
Wisma Pantai, B-12-7, Tower B - No 5,
Jalan 4/83 Off Jalan Pantai Baru
59200 Kuala Lumpur,
MALAYSIA
T : +02-3-2288 1730 / 1731
F : +02-3-2288 1732
ai-malaysia@arcelor.com

MEXICO

ArcelorMittal
International Trading & Sales
Calle Privada de los Industriales 110-A
8° Piso Desp. 801-802
Col. Industrial Benito Juárez
Querétaro, Qro. 76100,
MEXICO
T : +52-442-218 6872
F : +52-442-218 1400
ai-mexico@arcelormittal.com

PERU

ArcelorMittal
International Trading & Sales
Daniel Hernandez 639
Pueblo Libre
Lima 21,
PERU
T : +51-1-463 06 00
F : +51-1-463 06 38
ai-peru@arcelormittal.com

PHILIPPINES

ArcelorMittal
International Trading & Sales
4th Fl/Maga Centre
Paseo de Magallanes Commercial
Magallanes Village, Makati City 1200
PHILIPPINES
T : +63-2-8539297
F : +63-2-8539296
ai-philippines@arcelor.com

RUSSIA

ArcelorMittal
International Trading & Sales
Bolshaya Ordynka Street 44, building 4
119 017 Moscow
RUSSIA
T : +7-495-721 15 51
F : +7-495-721 15 55
ai-moscow@arcelormittal.com

SALVADOR (EL)

ArcelorMittal
International Trading & Sales
Boulevard Del Hipodromo # 645, Colonia San Benito
San Salvador,
EL SALVADOR
T : +503 2237 - 8653
ai-elsalvador@arcelormittal.com

SINGAPORE

ArcelorMittal
International Trading & Sales
9, Scotts Road #09-01 Pacific Plaza
228 210 Singapore
SINGAPORE
T : +65 67339033
F : +65 67325918
ai-singapore@arcelor.com

SOUTH AFRICA

ArcelorMittal
International Trading & Sales
Commerce Square
Building 3, 2nd Floor
39 Rivonia Road, Sandhurst, Sandton
P.O. Box 41850 Craighall 2024
REPUBLIC OF SOUTH AFRICA
T : +27-11-268 2561
F : +27-11-268 6416
Renier.vandermerwe@arcelormittal.com

TAIWAN

ArcelorMittal
International Trading & Sales
8F-A3; n° 502 Jiou Ru 1st Rd.;
San Min Dist., Kaohsiung,
TAIWAN ROC
T : +886-7-390 04 25
F : +886-7-390 04 27
ai-taiwan@arcelor.com

THAILAND

ArcelorMittal
International Trading & Sales
283/48 (Unit 1005-3), Home
Place Group Office Building
10th floor, Soi Sukhumvit, 55 Sukhumvit
Road, Wattana District
Bangkok 10110,
THAILAND
T : +66-2-712 74 35
F : +66-2-712 73 50
ai-thailand@arcelormittal.com

UNITED ARAB EMIRATES

ArcelorMittal
International Trading & Sales
LOB 15 525
Jebel Ali Free Zone
PO Box 262098
Dubai,
UAE
T : +971-4-881 1662
F : +971-4-881 1663
ai-dubai@arcelormittal.com

UNITED STATES OF AMERICA

ArcelorMittal
International Trading & Sales
1 South Dearborn
Chicago, IL, 60603,
USA
T : +1-312-899-3500
F : +1-312-899-3798
ai-america@arcelormittal.com

VENEZUELA

ArcelorMittal
International Trading & Sales
Edificio Keope, Avenida Vera Cruz, Piso 4, Oficina 45-A
Las Mercedes/Caracas 1060 A,
VENEZUELA
T : +58-212-993 46 35 / 993 81 01 / 991 41 97
F : + 58-212-992 13 42
ai-venezuela@arcelormittal.com

VIETNAM

ArcelorMittal
International Trading & Sales
D35, 40 Ba Huyen Thanh Quan, Ward 6,
Dist. 3, Ho Chi Minh City,
VIETNAM
T : + 84-8-9307248
F : + 84-8-9307246
ai-vietnam@arcelor.com

ArcelorMittal declina toda responsabilidad que pueda resultar de los errores u omisiones que, a pesar del cuidado aportado en la redacción y corrección de este catálogo, hubieran podido producirse, así como de cualquier perjuicio dimanante de una mala interpretación de sus contenidos.

Although every care has been taken during the production of this brochure, we regret that we cannot accept any liability in respect of any incorrect information it may contain or any damages which may arise through the misinterpretation of its contents.

Per quanto sia stata presa ogni precauzione durante la produzione di questa pubblicazione, ci dispiace informarvi che non accettiamo nessuna responsabilità sulla correttezza delle informazioni o danni conseguenti che potrebbero derivare dalla misinterpretazione del contenuto.

Notas / Notes / Note

A series of horizontal dotted lines for writing notes.

ArcelorMittal
Commercial Sections

66, rue de Luxembourg
L-4221 Esch-sur-Alzette
LUXEMBOURG
Tel. + 352 5313 3014
Fax + 352 5313 3087

www.arcelormittal.com/sections

Version 2008-1



Mixed Sources

Product group from well-managed
forests, and other controlled sources
www.fsc.org Cert no. EUR-COC-051203
© 1996 Forest Stewardship Council