



# MEDIOJET 2V

**4 kW; 5,5 Kw (50Hz)**  
**4,6 kW; 6,3 kW (60Hz)**

Per l'aspirazione di fluidi diversi dall'aria non contaminata o a temperature superiori ai 40°C vi preghiamo di contattarci.

*The standard side channel blowers/aspirators are designed to handle clean air up to a maximum of 40°C. Please contact us for special applications.*

Motori costruiti secondo le norme CEI 2-3 (1988) ISOL. CL F PROT. IP 55 e certificati cCSAus  
*Motors construction conform with CEI 2-3 (1988) NORMS. ISOL. CL F PROT. IP 55, cCSAus certified*



cCSAus file nr. 242079

Articolo Item code	kW	V	Hz	assorb. AMP absorbed AMPS	giri/min. r.p.m.	limite servizio max cont. duty S1 (mbar)	sonda termica motore elettrico (tipo) electric motor thermal sensor (type)	dB (A)*	peso (Kg) weight (Kg)	
TRIFASE THREE-PHASE	091610	4	200-240 Δ 345-415 Y	50	16.7 Δ 9.7 Y	2900	-315 +260	bi-metal (klixon)	77	57
	091610	4.6	220-275 Δ 380-480 Y	60	17.6 Δ 10.2 Y	3500	-295 +275	bi-metal (klixon)	81	57
	091621	5.5	200-240 Δ 345-415 Y	50	22.5 Δ 13 Y	2900	-320 +390	bi-metal (klixon)	77	60
	091621	6.3	220-275 Δ 380-480 Y	60	23.6 Δ 13.6 Y	3500	-335 +370	bi-metal (klixon)	81	60
	091624	5.5	200-240 Δ 345-415 Y	50	22.5 Δ 13 Y	2900	-390 +440	bi-metal (klixon)	77	60
	091624	6.3	220-275 Δ 380-480 Y	60	23.6 Δ 13.6 Y	3500	-380 +370	bi-metal (klixon)	81	60

\* Livello di pressione sonora rilevato secondo le Norme ISO 3746 - 1979 (E). Parametri: r=1 - Rumore di fondo 51 dB (A) - Strumento: Brüel & Kjær type 2232.  
\* Sound pressure level tested according to ISO regulation 3746 - 1979 (E). Parameters: r=1 - Background noise 51 dB (A) - Instrument: Brüel & Kjær type 2232.

## dimensioni:

## dimensions:

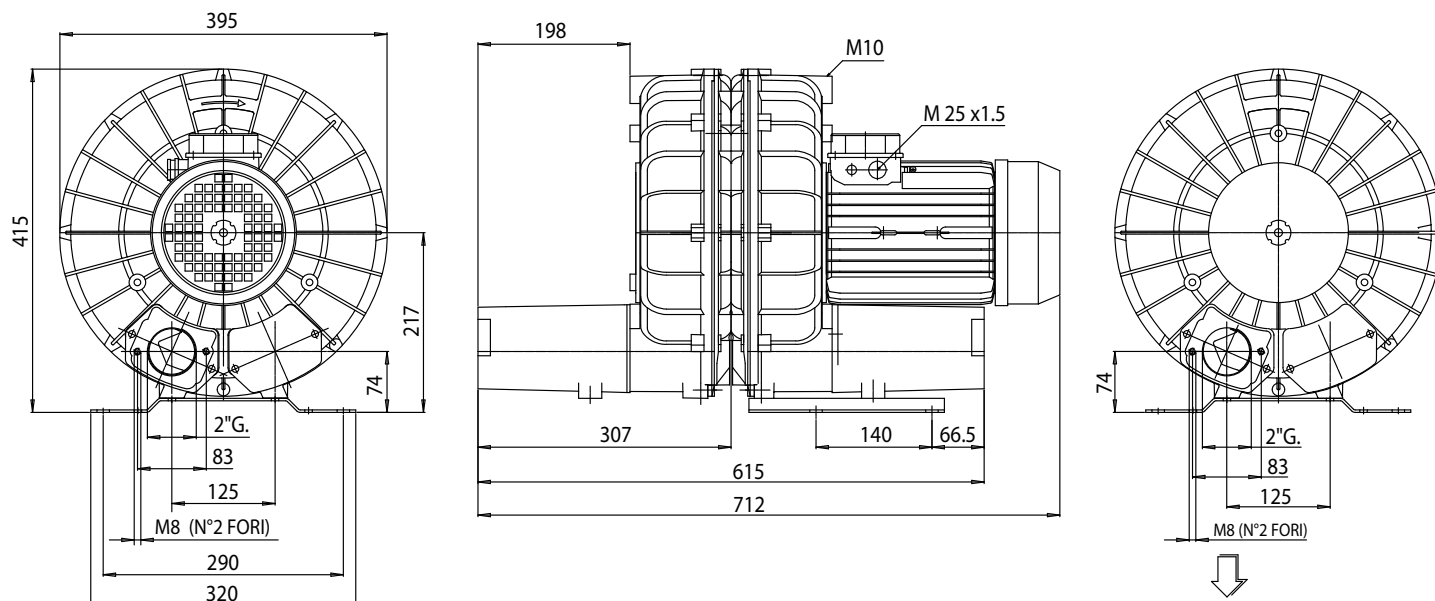

le dimensioni sono espresse in millimetri  
all dimensions are in mm

## ASPIRAZIONE VACUUM

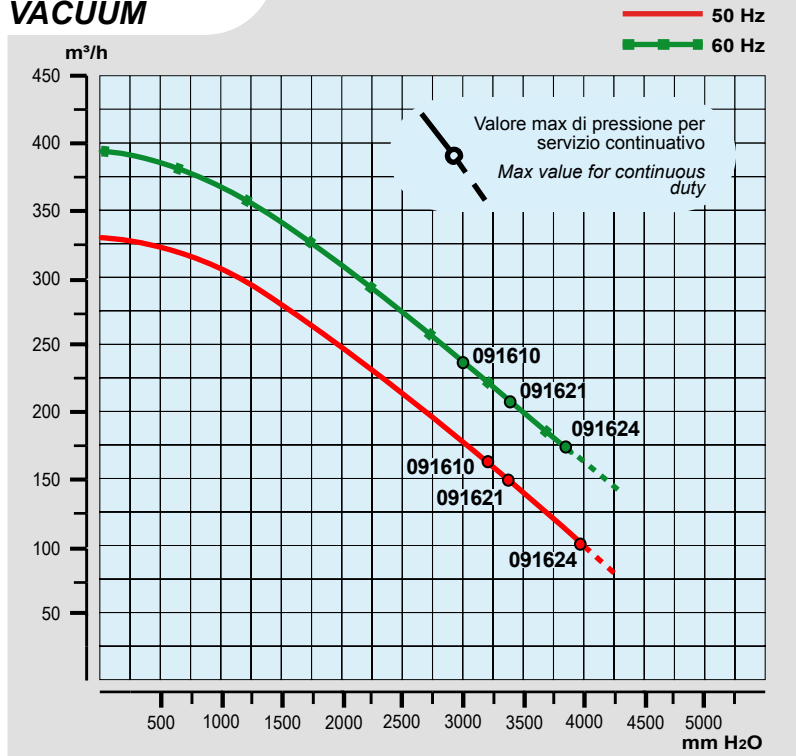

## ASSORBIMENTO MOTORE MOTOR ABSORPTION

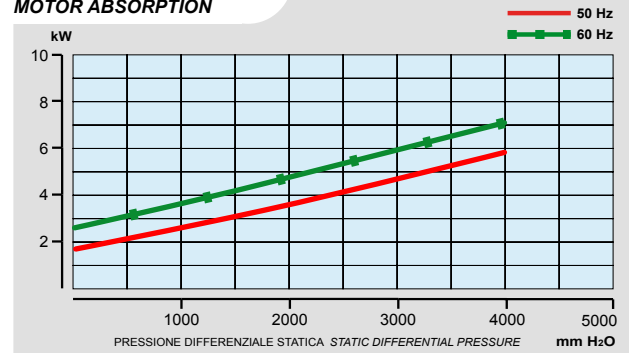

## INCREMENTO TEMPERATURA ARIA AIR TEMPERATURE INCREASE

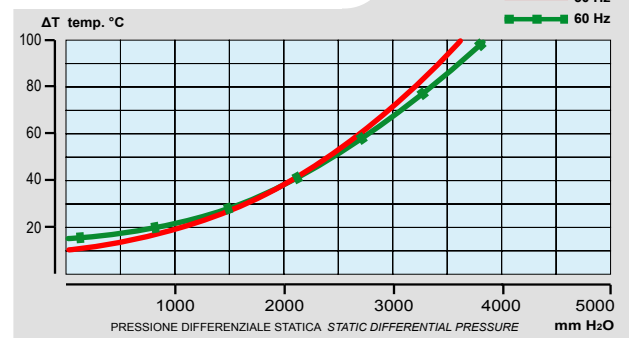

## COMPRESSIONE PRESSURE

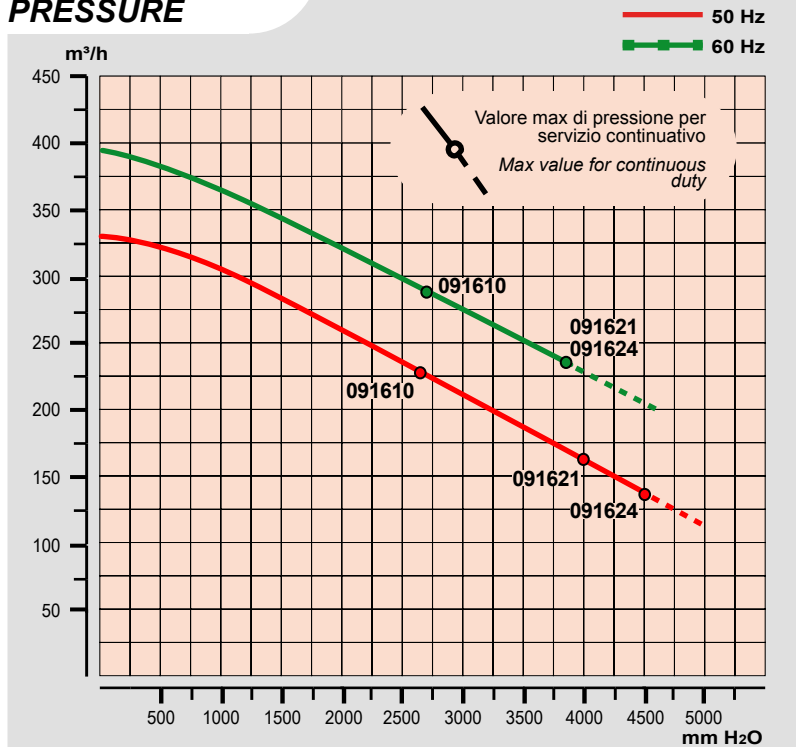

## ASSORBIMENTO MOTORE MOTOR ABSORPTION

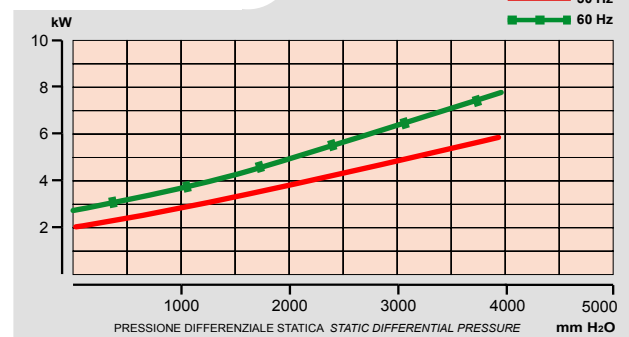

## INCREMENTO TEMPERATURA ARIA AIR TEMPERATURE INCREASE

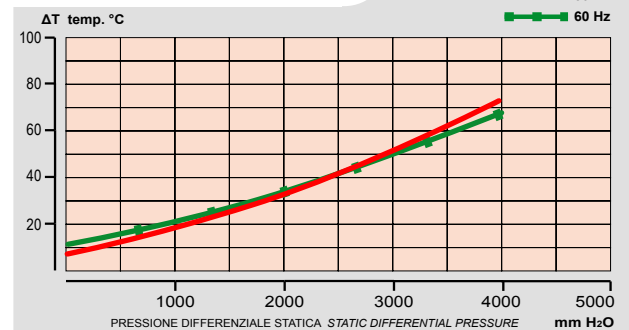

Tutti i dati della presente scheda tecnica si intendono indicativi e potranno essere modificati dalla casa in qualsiasi momento senza nessun preavviso.

La curva di aspirazione è riferita ad aria alla temperatura media di 20 °C e 1013 mbar sul raccordo di mandata.  
La curva di compressione è riferita ad aria alla temperatura media di 20 °C e 1013 mbar sul raccordo di aspirazione.

All data is intended as an indication and may be modified without prior notice.

The vacuum curve is valid for pumping air, with a temperature of 20°C at the inlet flange and with a pressure of 1013 mbar at the discharge port.  
The pressure curve is valid for pumping air, with an average temperature of 20°C and 1013 mbar at the inlet flange.

l/min = m<sup>3</sup>/h · 16,667  
CFM = m<sup>3</sup>/h · 0,588  
mbar = mm H<sub>2</sub>O · 0,098  
PSI = mm H<sub>2</sub>O · 0,00142