

## Hydraulic Pump Purpose :

*Provide the Flow needed to transmit power from a prime mover to a hydraulic actuator.*

## Types of Hydraulic Pumps

- **Centrifugal**
  - **Flow dependent on speed and outlet pressure**
    - **Primarily fluid transfer**
- **Positive Displacement**
  - **Flow dependent on speed and displacement, independent of pressure**
    - **Primarily fluid power**

# Hydraulic Piston Pump Basics

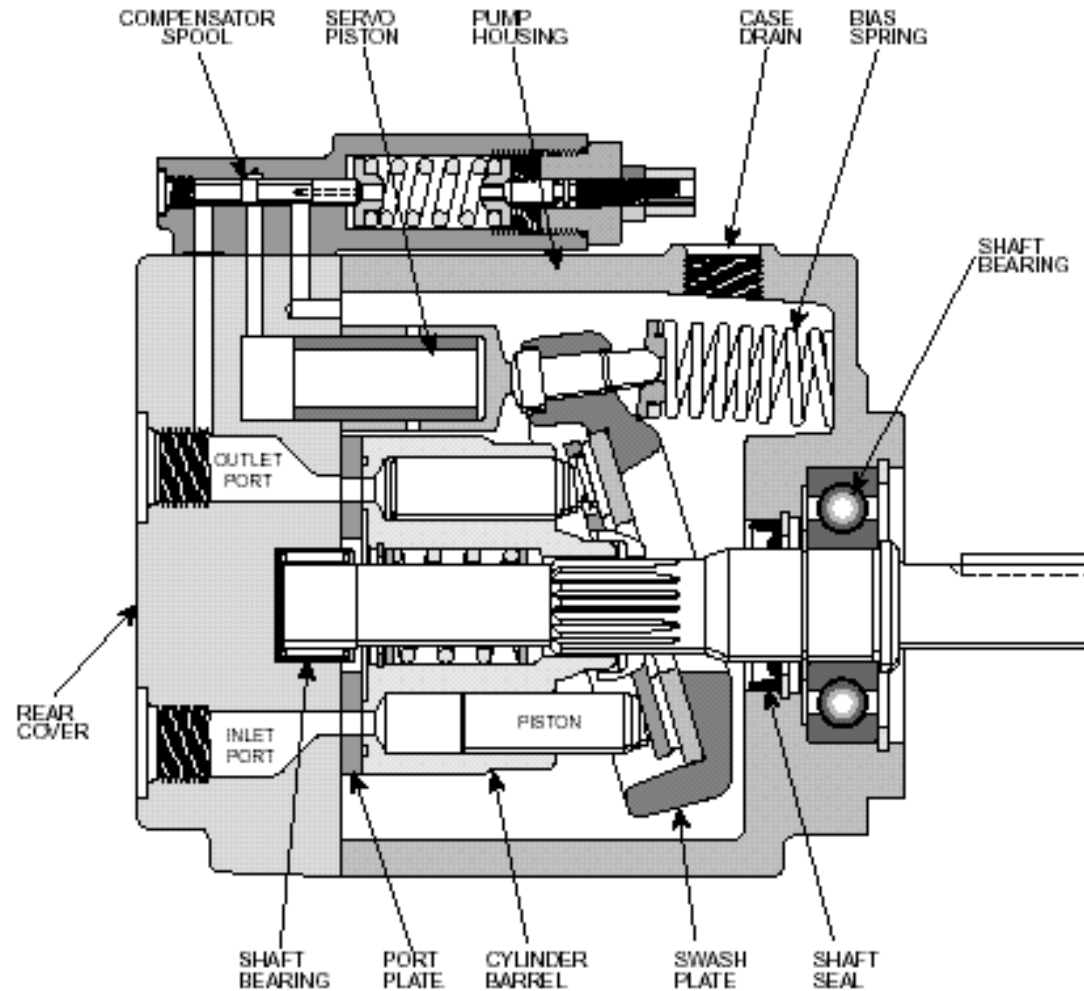

**Hydraulic Flow is developed as the pump rotating group is driven by a prime mover**

***-Fluid is forced out of pump at the pump outlet***

***-A Partial vacuum is created at the pump inlet and atmospheric pressure forces fluid into pump from the reservoir***

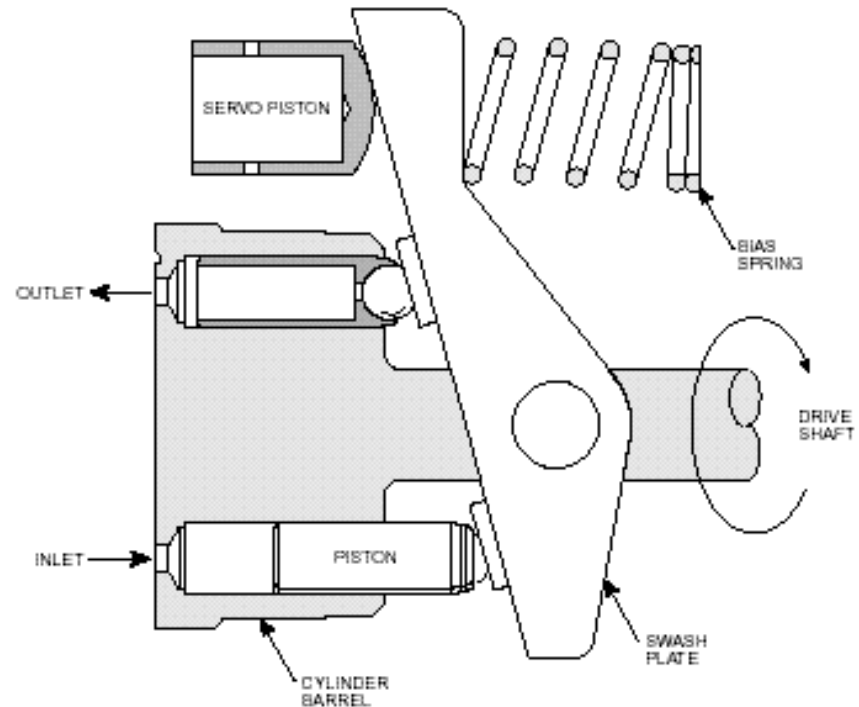

## POSITIVE DISPLACEMENT PUMPS

- **Displacement**

*Cubic Inches (cc) per Revolution of drive shaft*

- **Flow**

*Displacement X Shaft Speed X Volumetric Efficiency*

## POSITIVE DISPLACEMENT PUMPS

- ***Fixed Displacement***
  - *Flow varies only with shaft speed*
  - *Typical types Gear Pumps and Vane Pumps*
  
- ***Variable Displacement***
  - *Flow can be varied at a given shaft speed*
  - *Typical type is Variable Piston Pumps*

## POSITIVE DISPLACEMENT PUMPS

- **Fixed Displacement**
  - *Good for constant flow and pressure applications*
  - *Typically less expensive than variable pump systems*
- **Variable Displacement**
  - *Good for variable flow and / or pressure applications*
  - *Typically more energy efficient because flow and pressure ( Horsepower) more closely matches load.*

## Variable Displacement Piston Pump

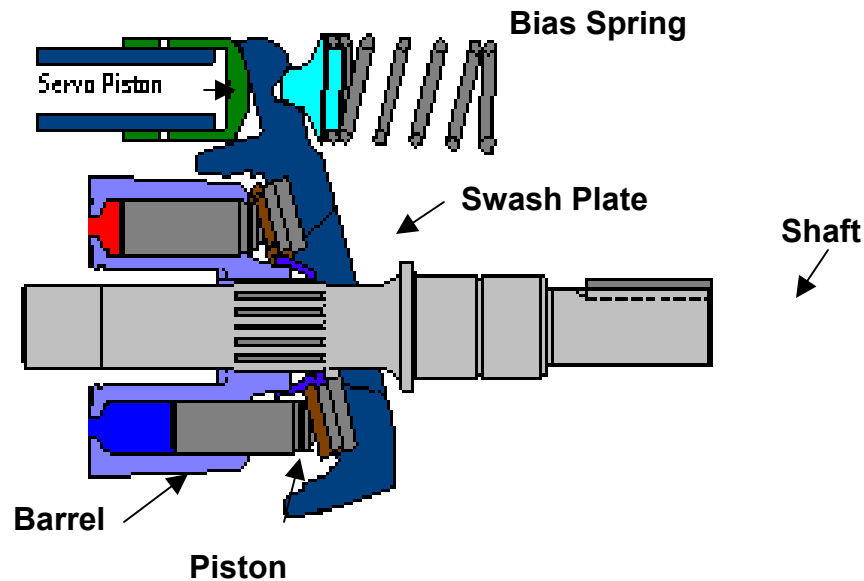

Outlet Flow can be varied by changing the shaft drive speed, or by changing the swash plate angle



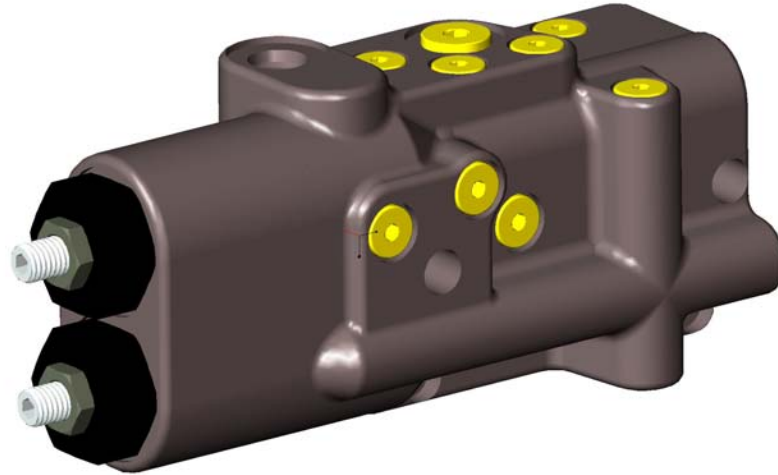

**Piston Pump Controls are integral valves that port flow to a stroking piston in response to a pressure or electronic signal , which results in a variable hydraulic pump achieving a desired displacement.**

## **Common Variable Piston Pump Controls**

- **Pressure Compensator**
  - ❖ **The pressure compensator control will limit pump outlet pressure to a predetermined level and adjust pump outlet flow to the level needed to maintain the set pressure**
- **Load Sense Control**
  - ❖ **Load sense control will adjust output flow to maintain a constant pressure drop across an orifice**
- **Torque Limiter Control**
  - ❖ **Will adjust flow to limit the input torque demand of the pump**
- **Electronic Displacement Control**
  - ❖ **Will adjust output flow in proportion to an electronic command .**

**Pressure compensated Pump will provide full pump flow at pressures below the compensator setting. Once the pump flow is restricted, pressure will build up to the setting of the compensator and then the pump will destroke to the level needed to maintain the compensator pressure setting**

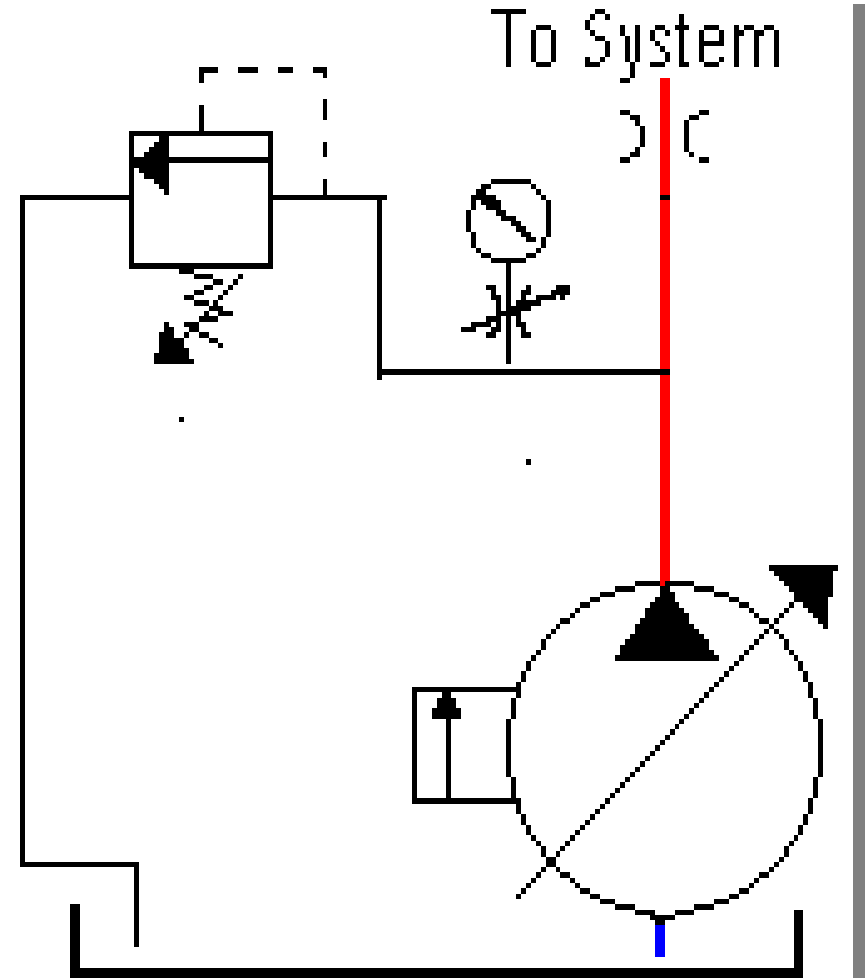

# Pressure Compensator

Pressure compensated Pump will provide full pump flow at pressures below the compensator setting. Once the pump flow is restricted, pressure will build up to the setting of the compensator and then the pump will destroke to the level needed to maintain the compensator pressure setting

*By the way, do you need this relief valve ?*

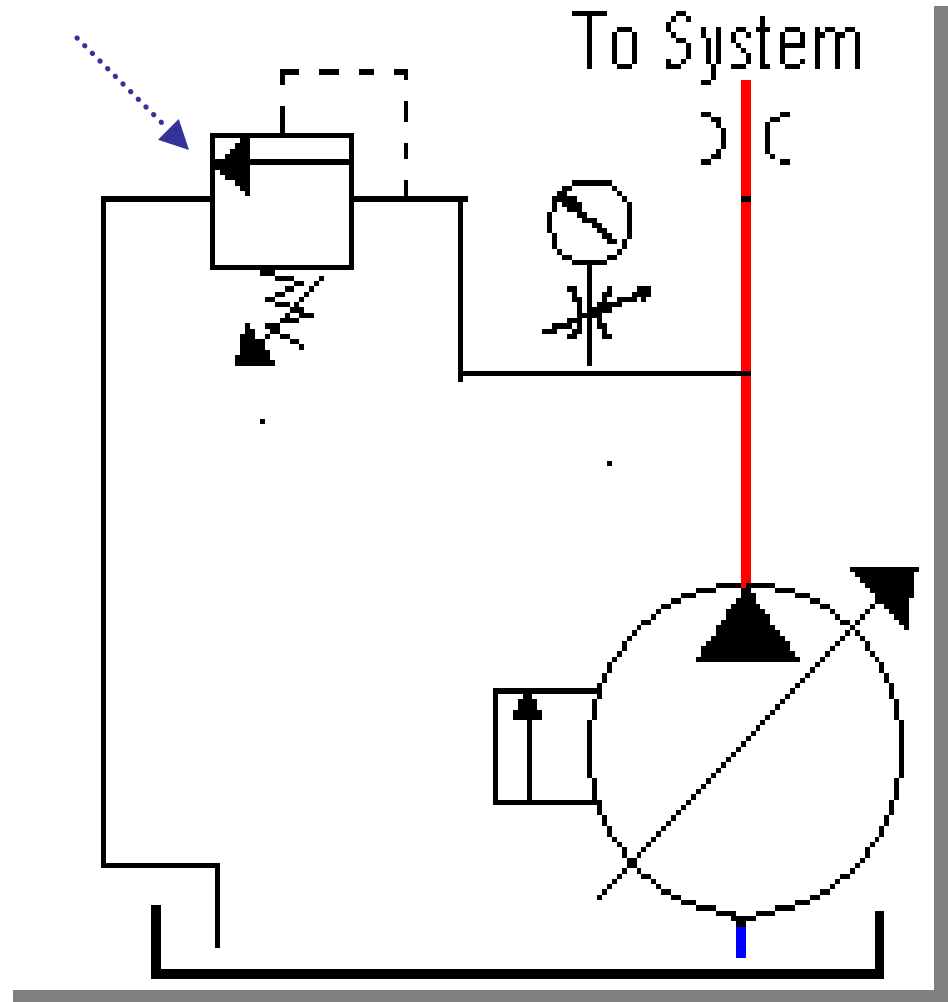

## ***Standard Pressure Compensator***

- **At pressures below the compensator setting, flow remains maximum.**
- **When compensator setting is reached, the pump de-strokes to provide the flow required to maintain the set pressure. The pump will maintain maximum pressure until system pressure drops.**

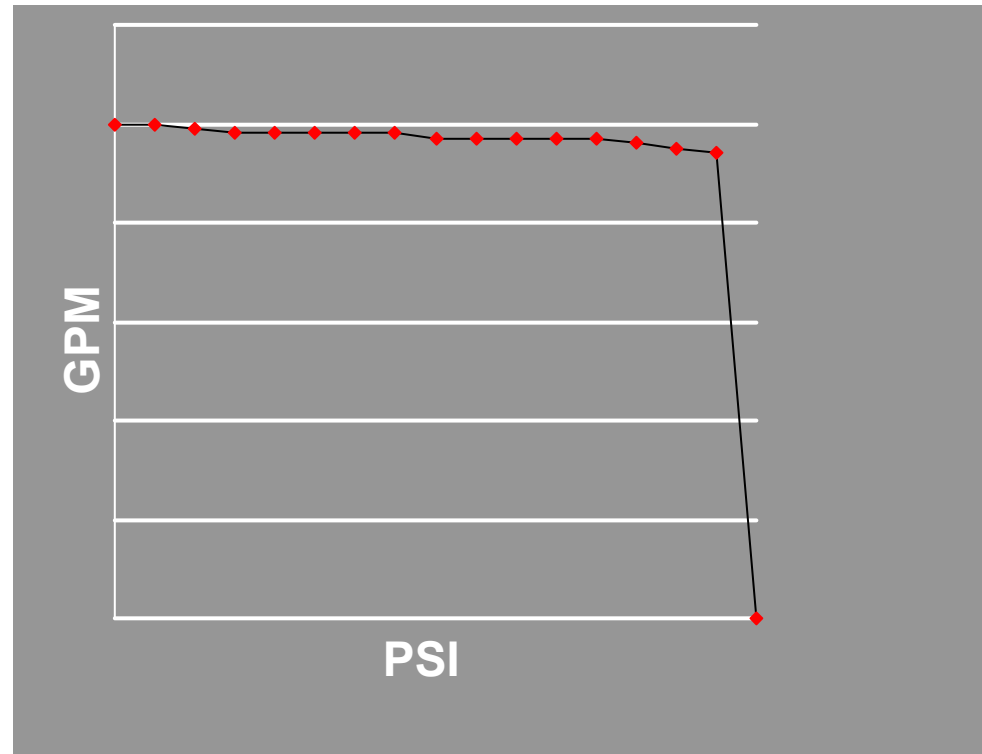

# Pressure Compensator

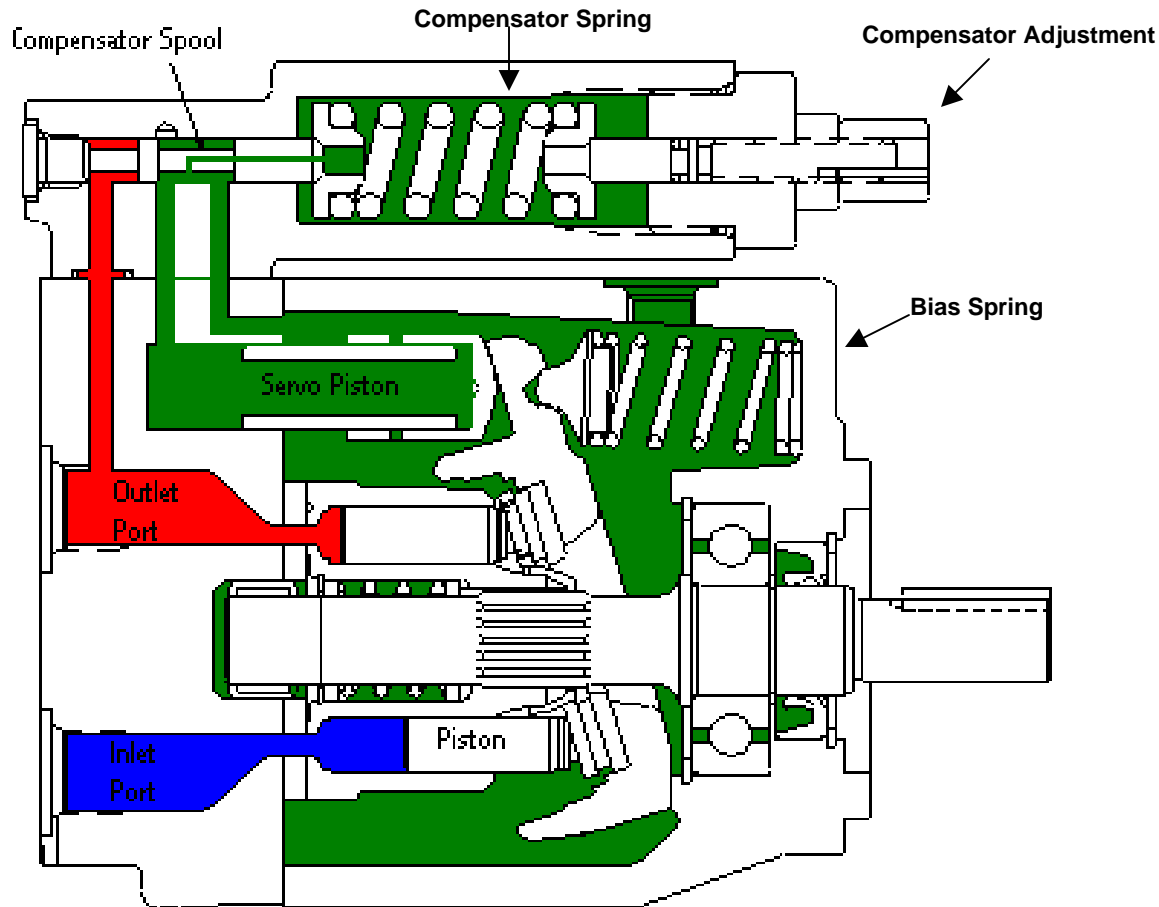

Pump Pressure is below setting of control  
Pump is at Full Stroke

# Pressure Compensator

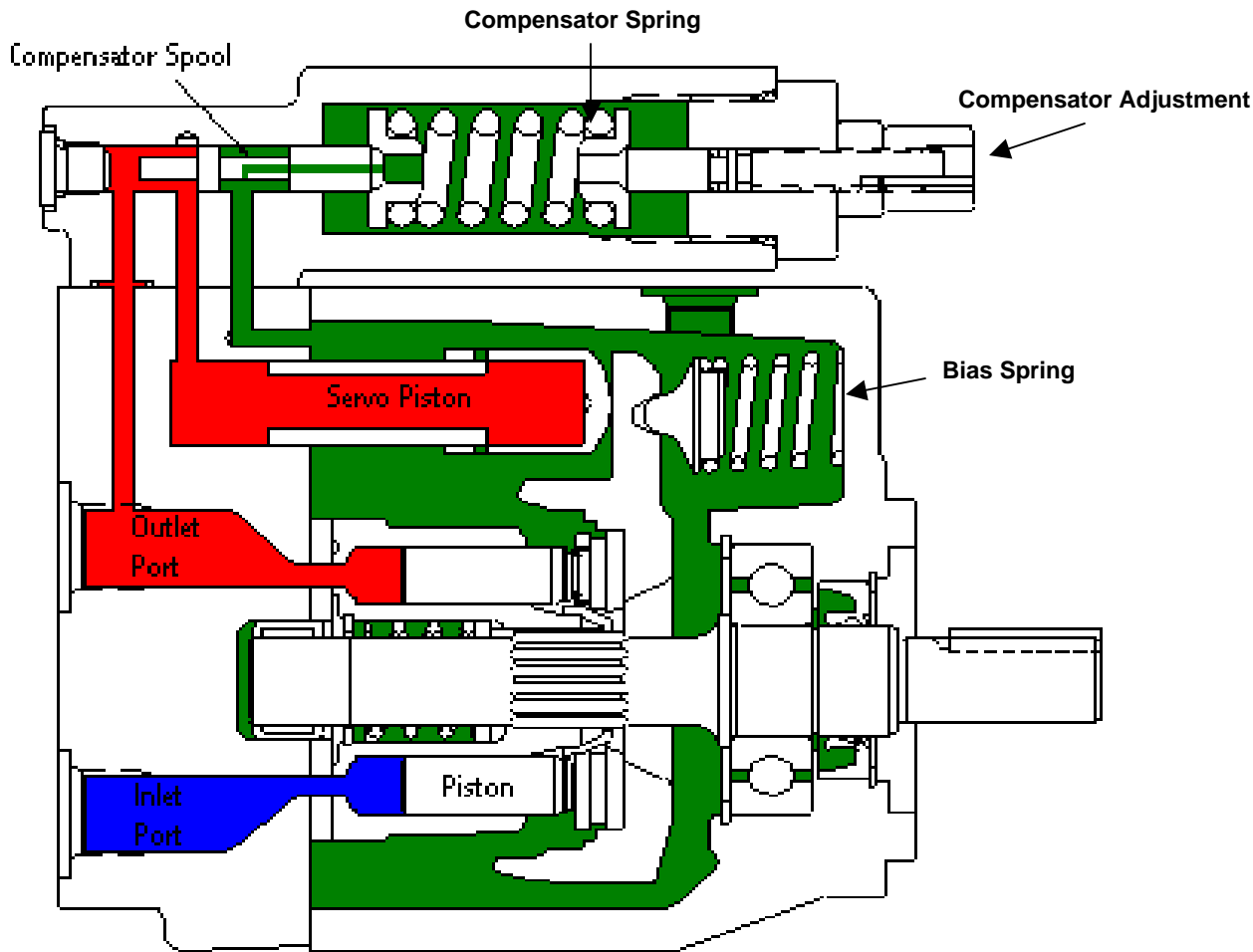

Pump Pressure is above setting of control

Pump is at reduced Stroke

## Problem

**10 GPM Fixed Pump**

**Relief Valve Set at 3000 PSI**

**Flow Control Set for 5 GPM**

**Load Pressure is 2000 PSI**

**What is the horsepower being consumed while the cylinder is extending ?**

**How much horsepower is being wasted ?**

**$(HP = GPM * PSI / 1714$**

***assume 100 % efficiency)***

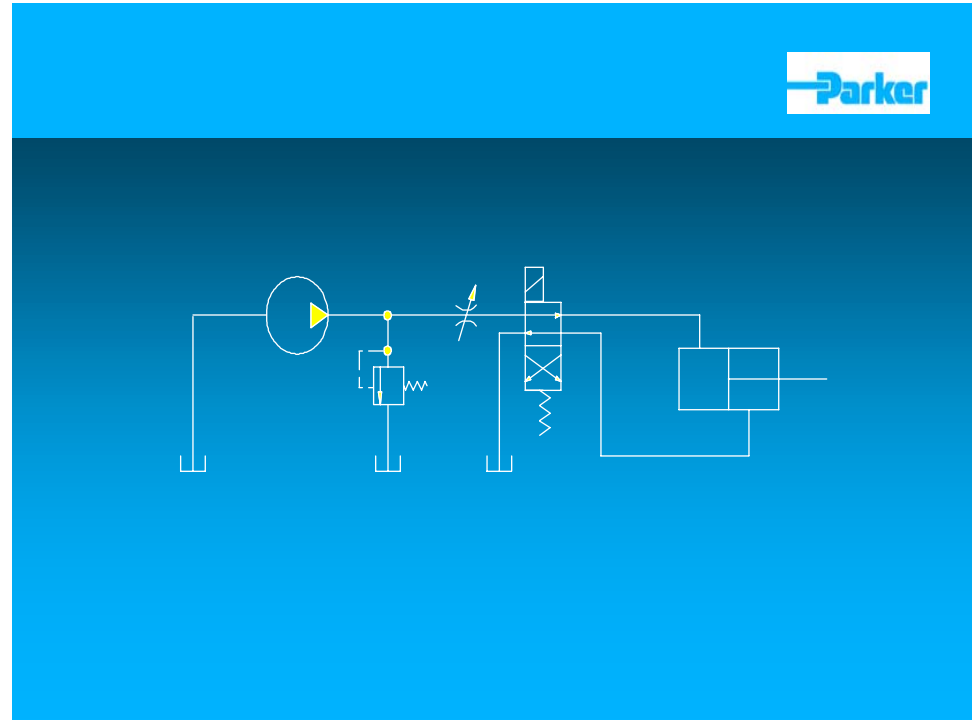



## Problem

**10 GPM Fixed Pump**

**Relief Valve Set at 3000 PSI**

**Flow Control Set for 5 GPM**

**Load Pressure is 2000 PSI**

**What is the horsepower being consumed while the cylinder is extending ?**

$$10 \text{ GPM} * 3000 \text{ PSI} / 1714 = 17.5 \text{ HP}$$

**How much horsepower is being wasted ?**

$$5 \text{ GPM} * 3000 \text{ PSI} / 1714 = 8.7 \text{ HP}$$

$$5 \text{ GPM} * 1000 \text{ PSI} / 1714 = 2.9 \text{ HP}$$

$$\text{Total} = 11.6 \text{ HP}$$

**(assume 100 % efficiency)**

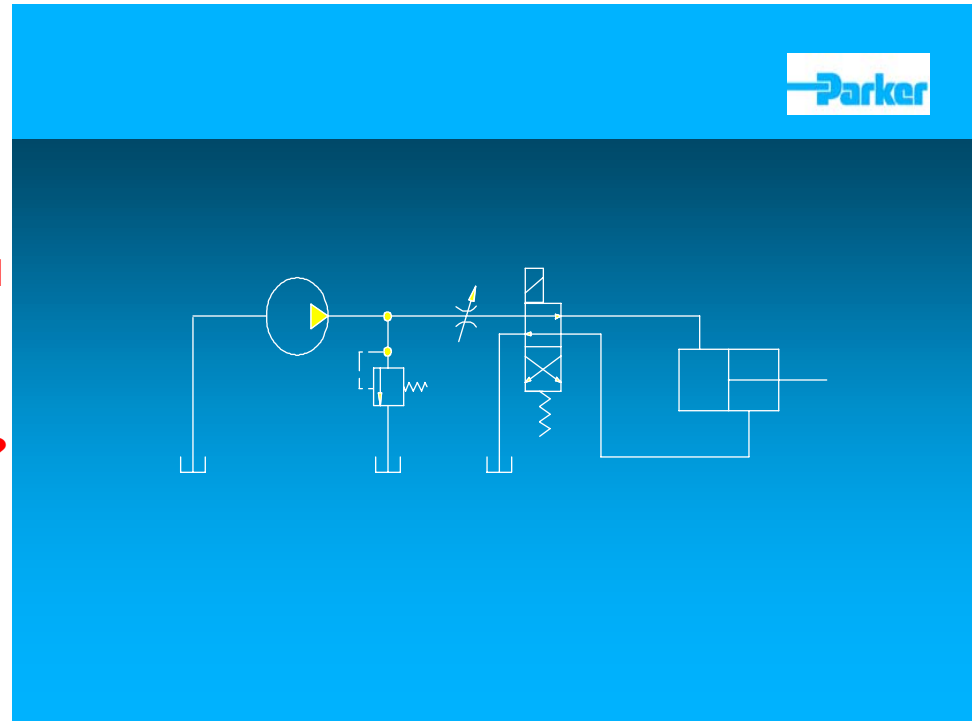

## Problem

**10 GPM Pressure Compensated Pump**  
**Pressure Compensator set at 3000 PSI**  
**Relief Valve Set at 3200 PSI**  
**Flow Control Set for 5 GPM**  
**Load Pressure is 2000 PSI**

**What is the horsepower being consumed while the cylinder is extending ?**

**How much horsepower is being wasted ?**

**( $HP = GPM * PSI / 1714$   
assume 100 % efficiency)**

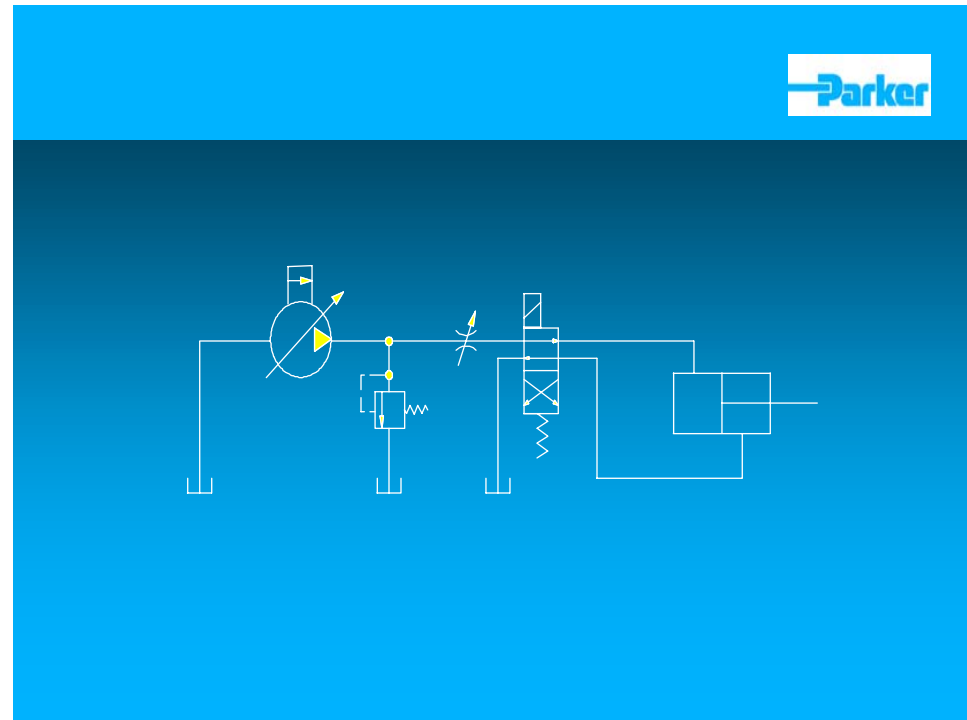

## Problem

**10 GPM Pressure Compensated Pump**

**Pressure Compensator set at 3000 PSI**

**Relief Valve Set at 3200 PSI**

**Flow Control Set for 5 GPM**

**Load Pressure is 2000 PSI**

**What is horsepower being consumed while the cylinder is extending ?**

$$5 \text{ GPM} * 3000 \text{ PSI} / 1714 = 8.7 \text{ HP}$$

**How much horsepower is being wasted ?**

$$5 \text{ GPM} * 1000 \text{ PSI} / 1714 = 2.9 \text{ HP}$$

$$(HP = GPM * PSI / 1714$$

*assume 100 % efficiency)*

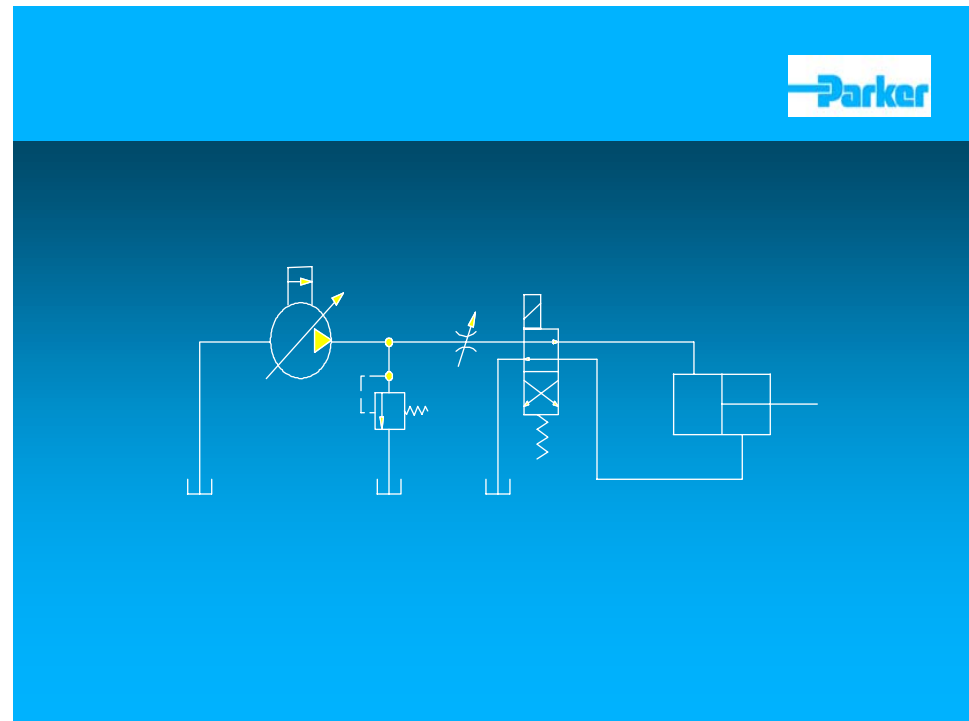

## Problem

**10 GPM Pressure Compensated Pump**

**Pressure Compensator set at 3000 PSI**

**Relief Valve Set at 3200 PSI**

**Flow Control Set for 5 GPM**

**Load Pressure is 2000 PSI**

**What is horsepower being consumed while the cylinder is extending ?**

$$5 \text{ GPM} * 3000 \text{ PSI} / 1714 = 8.7 \text{ HP}$$

**How much horsepower is being wasted ?**

$$5 \text{ GPM} * 1000 \text{ PSI} / 1714 = 2.9 \text{ HP}$$

$$(HP = GPM * PSI / 1714$$

*assume 100 % efficiency)*

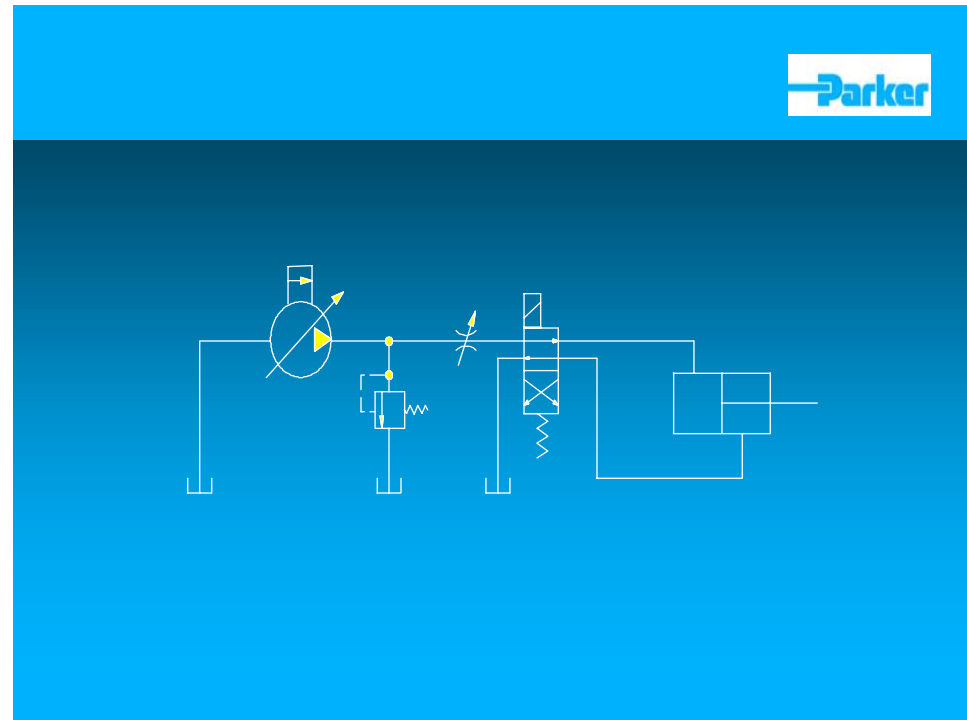

**Remember the Fixed Pump system used 17.5 HP and wasted 11.6 HP**

# Pressure Compensator

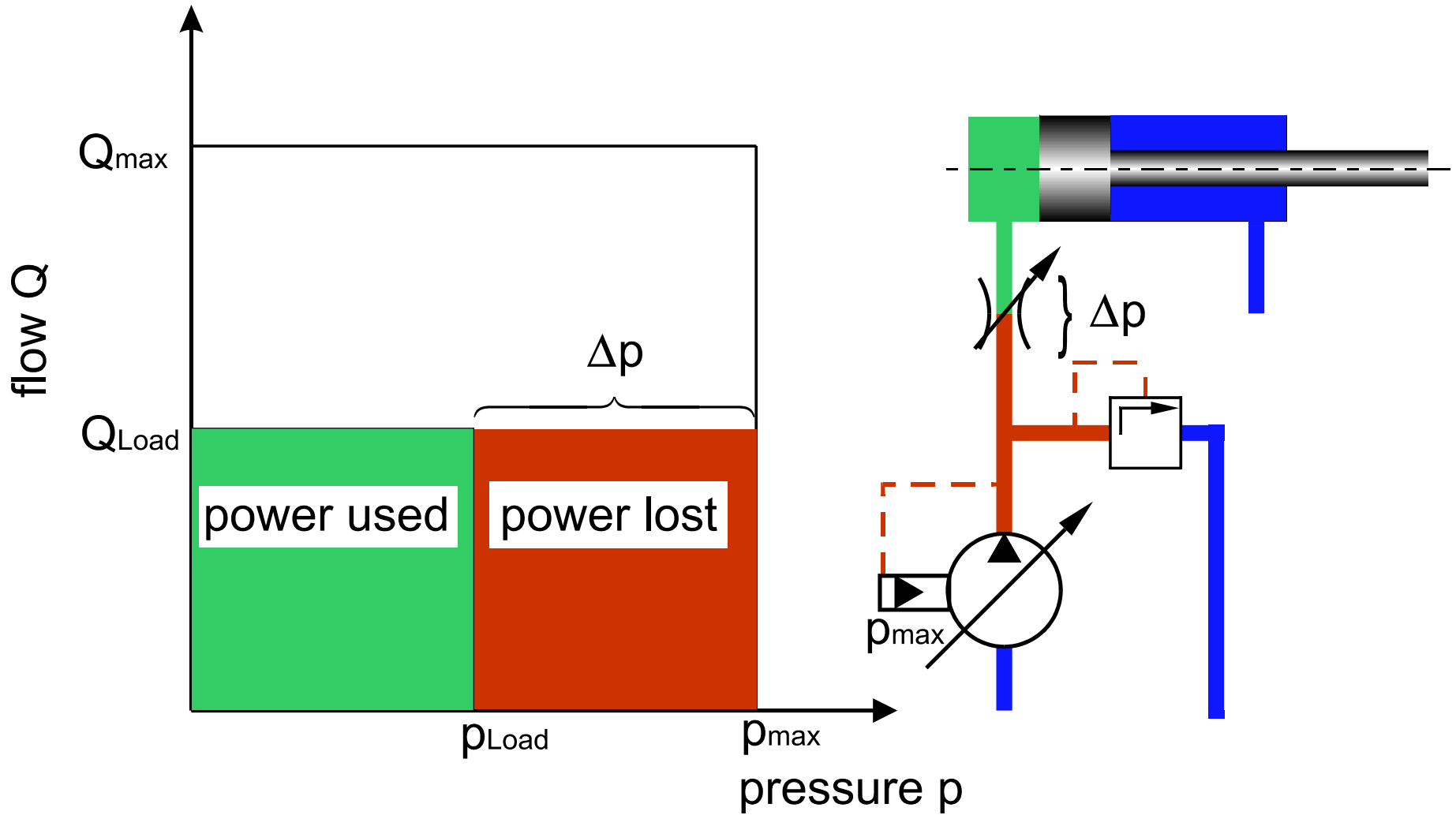

Remote compensator allows control of pump from a remote location from a relief valve located in a different location.

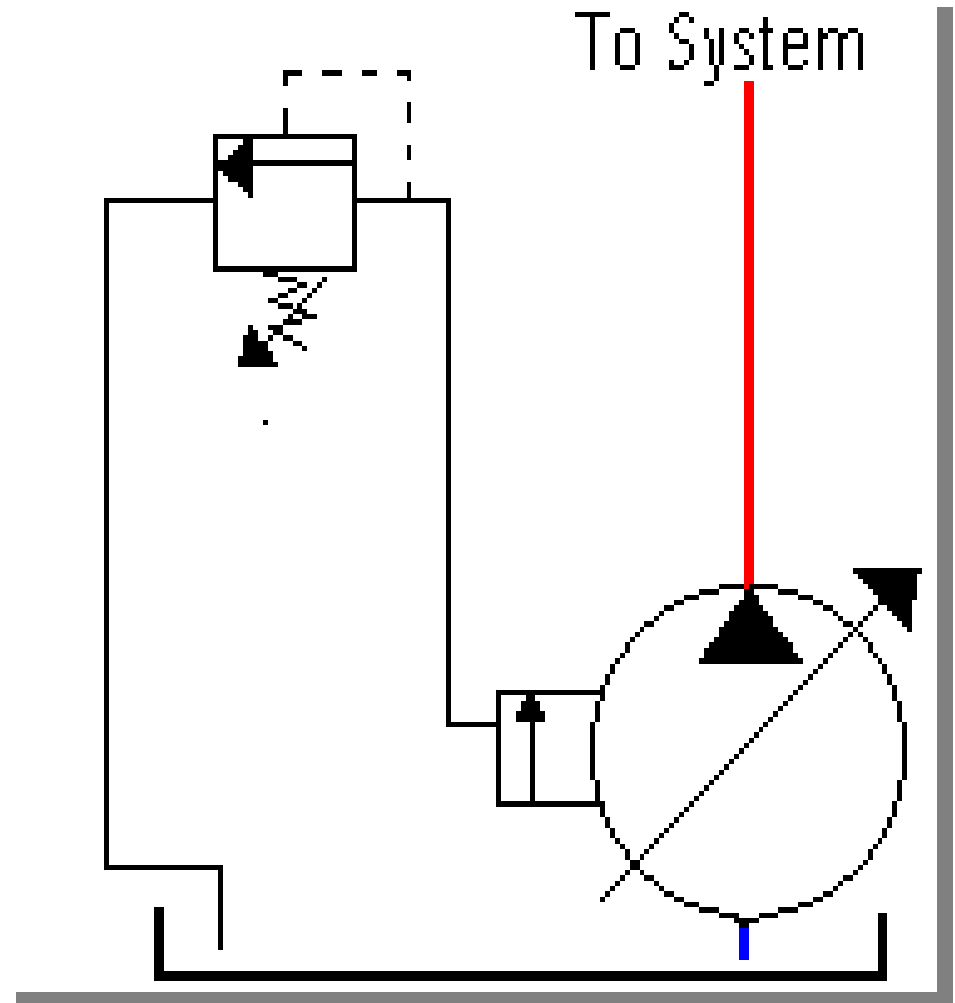

Remote compensator allows control of pump from a remote location. With addition of a 2 way valve the pump can be forced into a low pressure (differential spring) stand-by condition. Less noisy (by 1/3), no heat from case drain, power savings

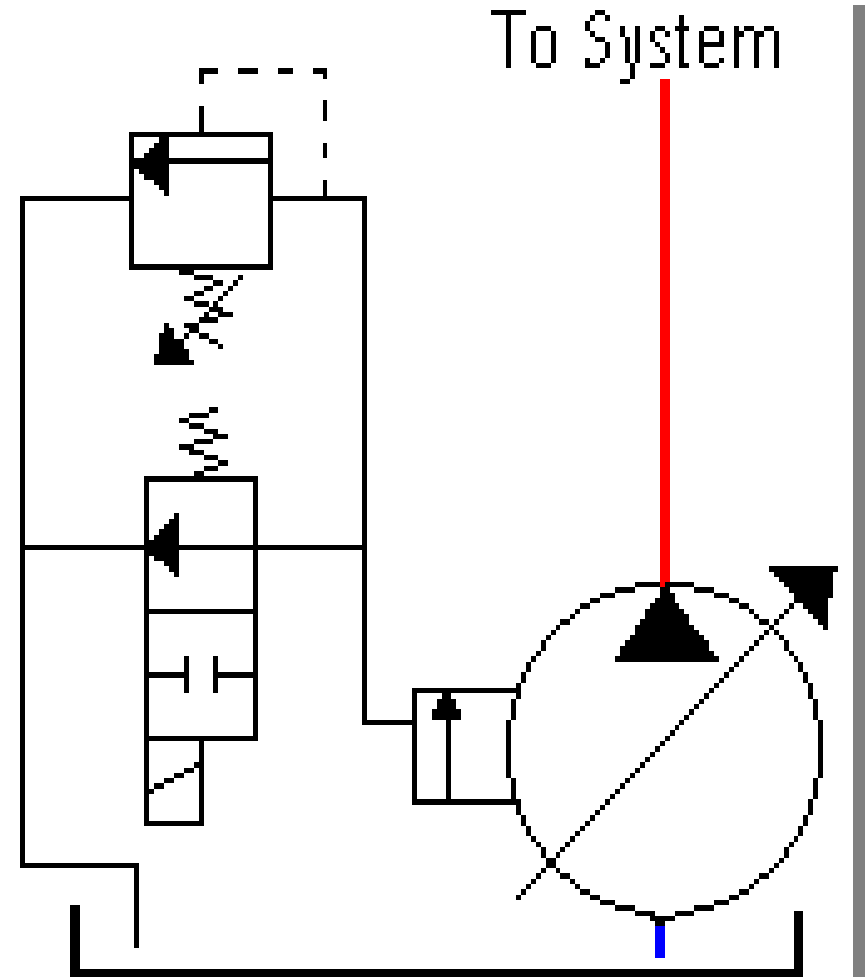

## Remote Pressure Compensator

- At pressures below the remote relief valve setting, flow remains maximum.
- When relief valve setting is reached, the pump de-strokes to actual required (or zero) flow. The pump will maintain remote relief valve pressure until the system pressure drops.

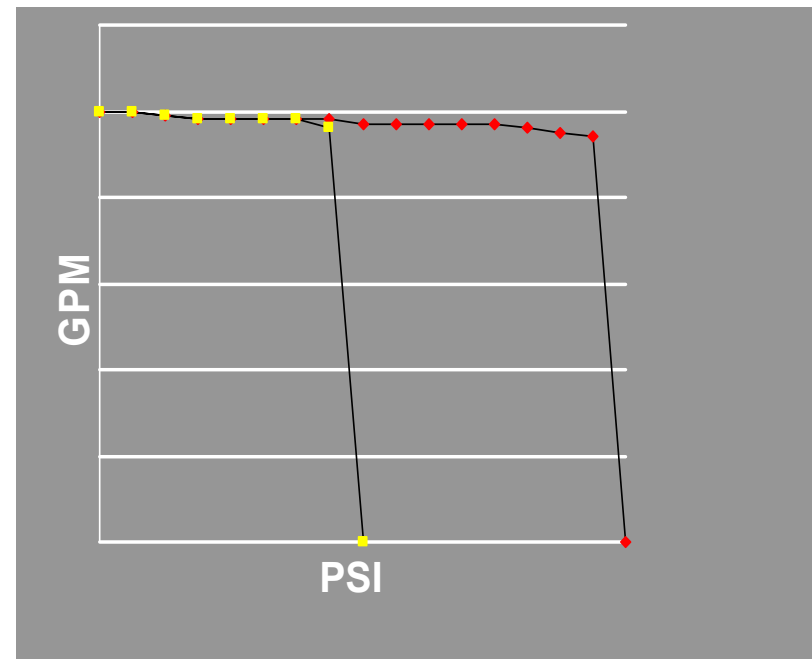



# Remote Compensator

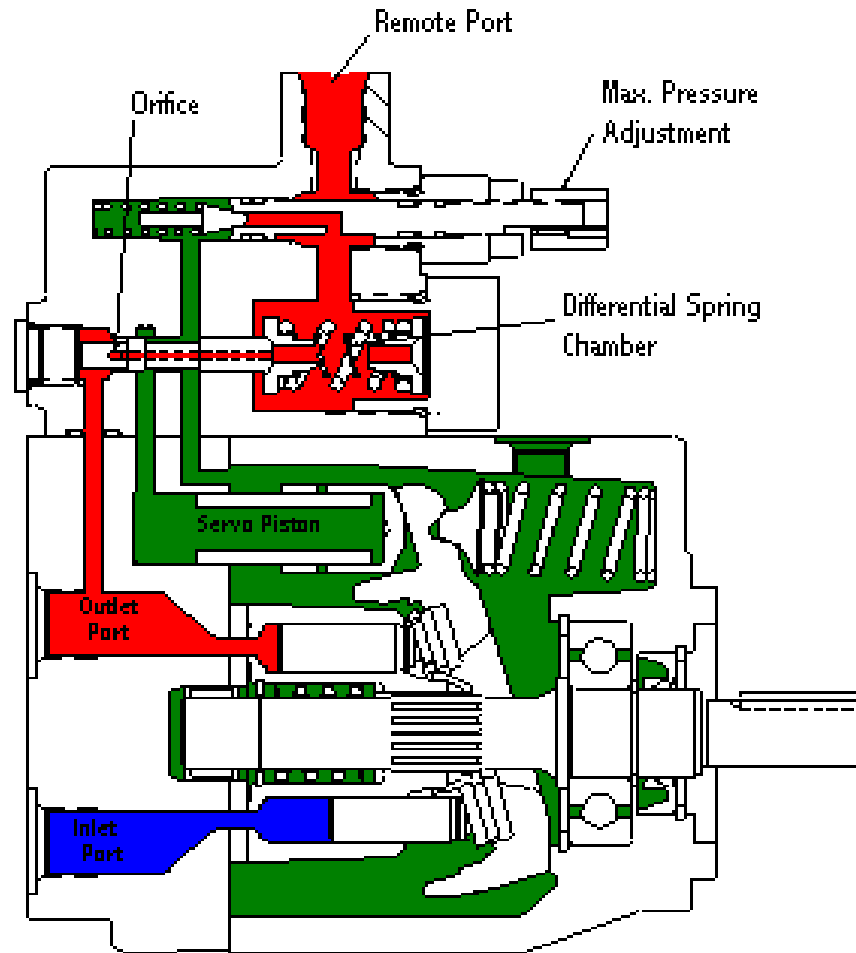

Just like a standard Pressure Compensator, except the pressure limiter adjustment is done with an external relief valve.

Pump Pressure is below setting of remote relief valve and below the setting of the poppet spring in the control .

Pump is at Full Stroke

# Remote Compensator

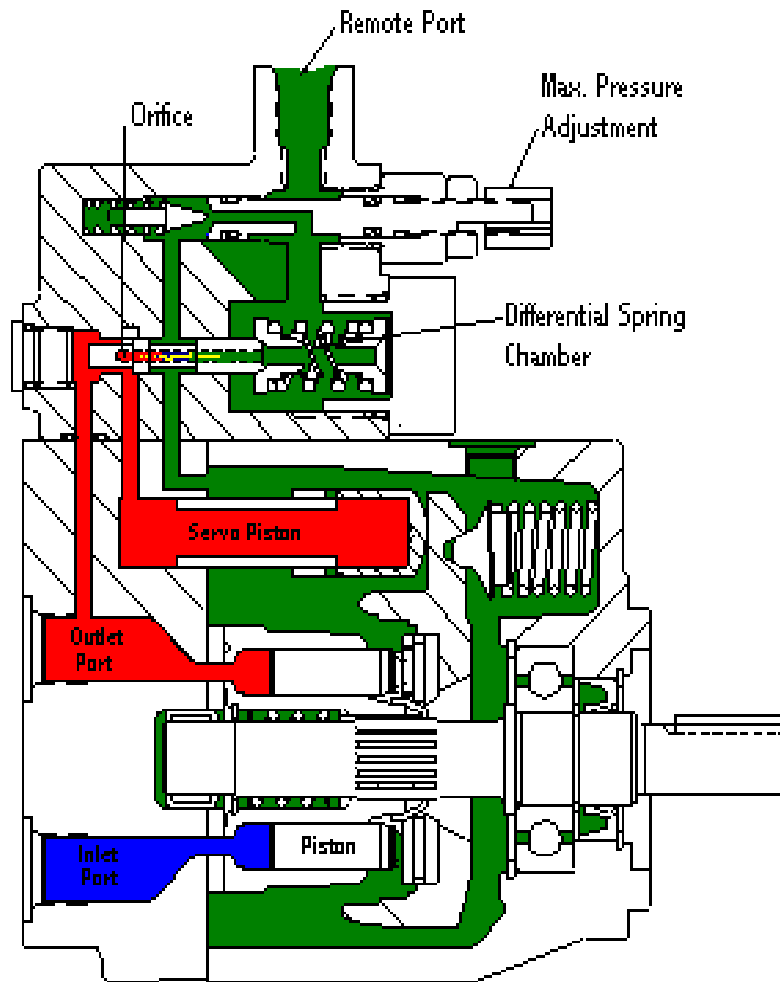

As Pump Pressure reaches setting of remote relief valve, the pressure in the differential spring chamber is limited and the spool shifts to destroy the pump.

## Load Sense Control

Load Sense control will match the output flow to the circuit demand at a pressure slightly above the load pressure.

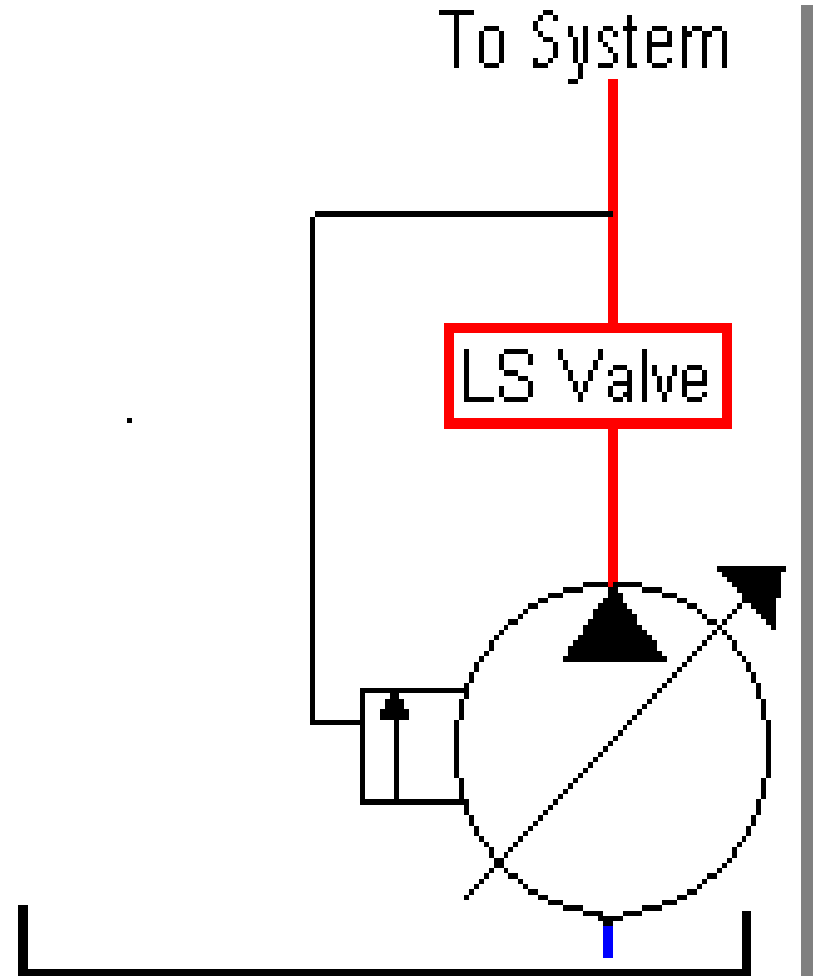

## Load Sense Control

- The load sense comp will increase or decrease the output flow to maintain a constant delta across the load orifice. This means that regardless of load conditions the flow will remain constant for a given orifice opening.

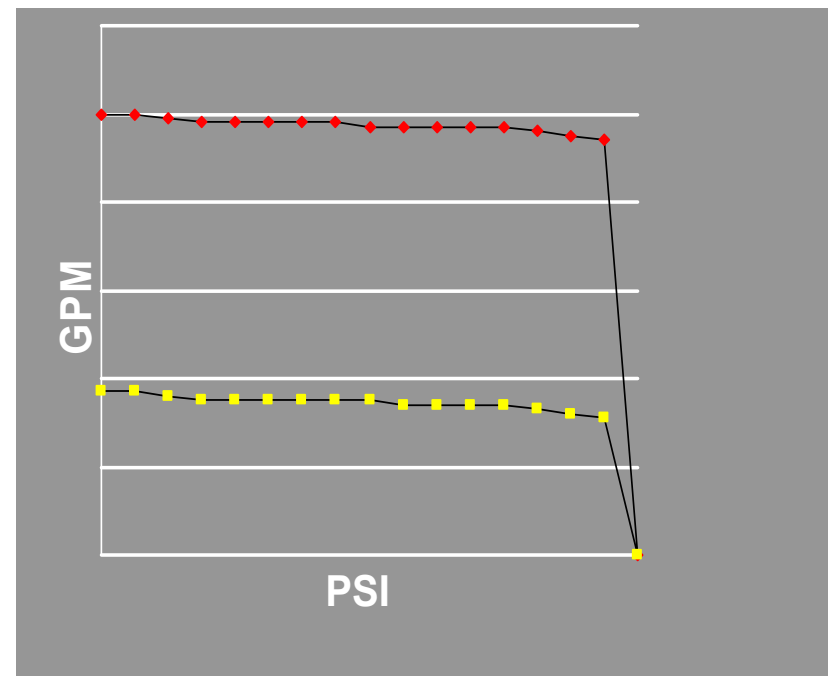

# Load Sense Control

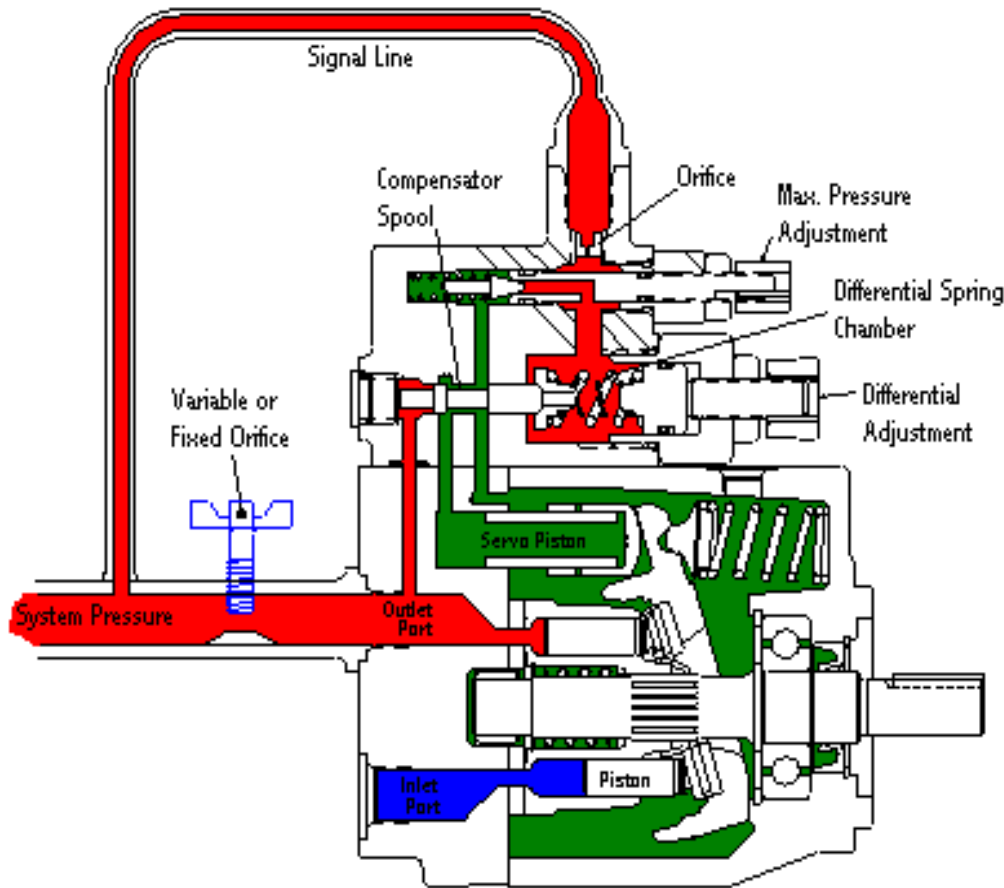

A load sense compensator will react to increases in the load by increasing output pressure. This is done by sensing the pressure drop across an external orifice and adjusting displacement to maintain a constant pressure drop across the orifice.

# Load Sense Control

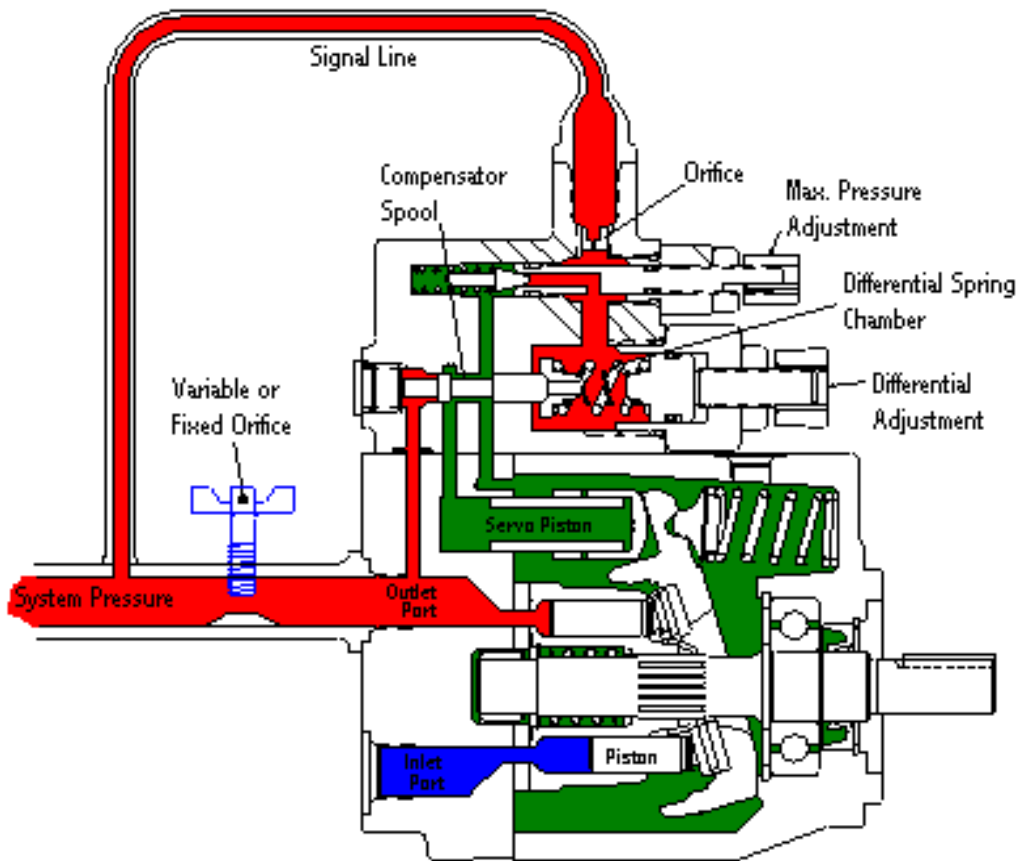

In this view the variable orifice is wide open and it is not restricting the pump flow. Pump outlet pressure and load pressure are equal. Since the pressure is equal on both sides of the spool, the differential spring keeps the spool to the left. There is no control pressure in the servo piston, so the pump will stay at full stroke.

# Load Sense Control

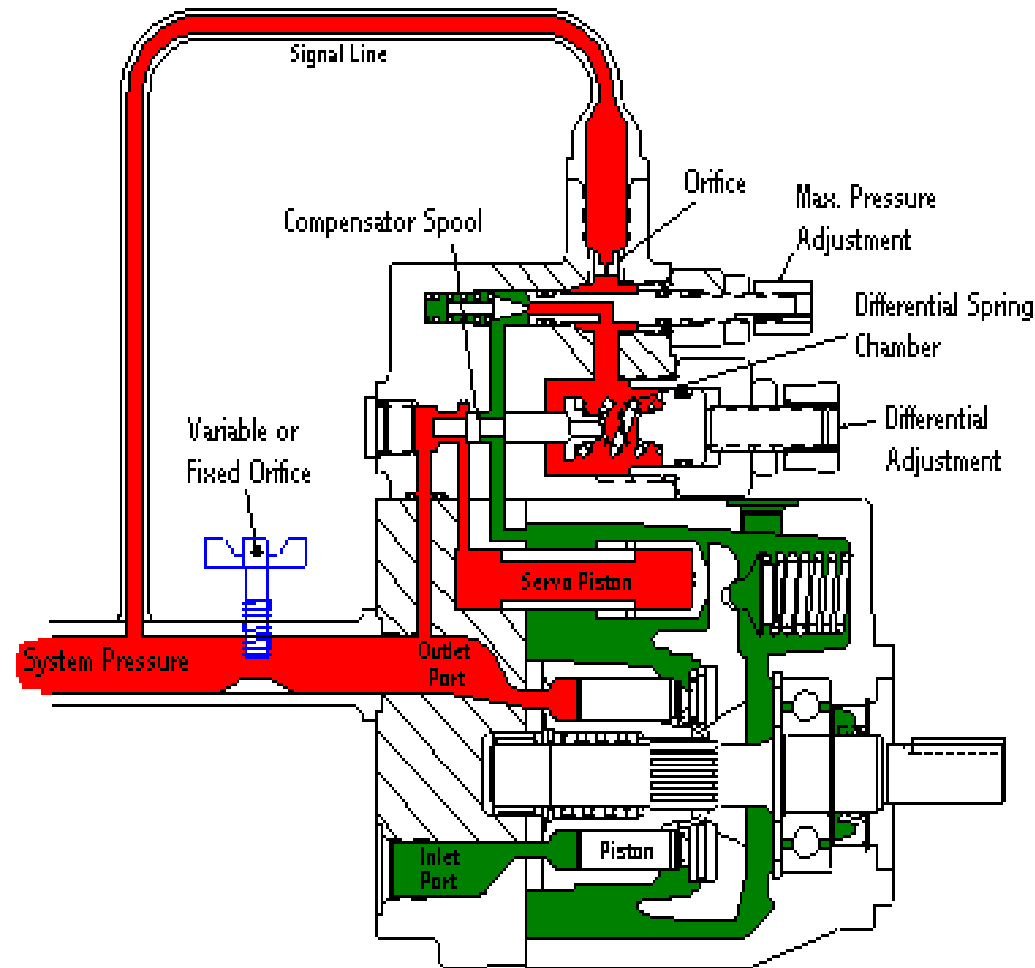

In this view the variable orifice is restricting pump flow . Pump outlet pressure is increased and a pressure drop is created across the orifice. The pump pressure will increase until it overcomes the differential spring force and shifts the spool to direct control oil into the servo piston and destroke the pump. The pump will maintain a flow level that keeps the pressure drop across the variable orifice constant ( equivalent to the differential spring setting).

# Load Sense Control

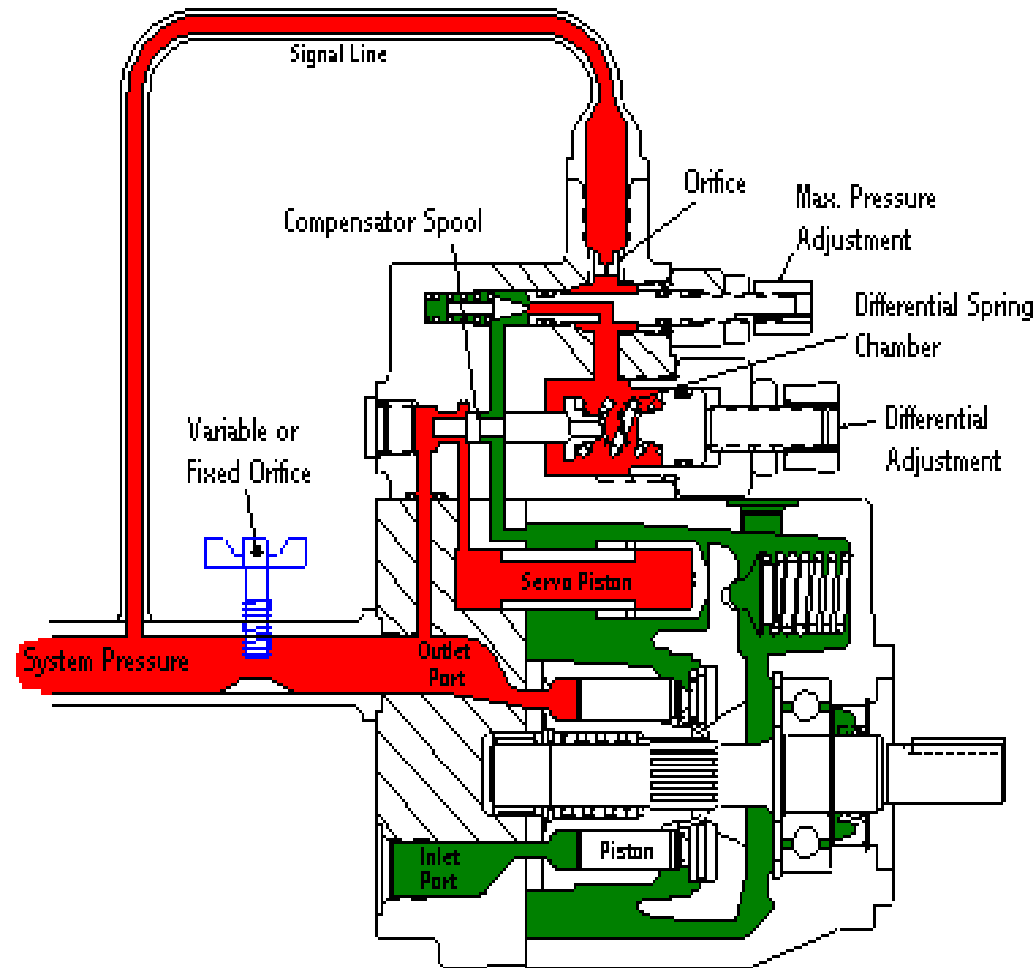

Since the load sense control will adjust pump flow to maintain the pressure drop across the orifice constant, increasing the orifice size will increase the flow to the system. Closing the orifice, will decrease the flow to the system.



# Load Sense Control

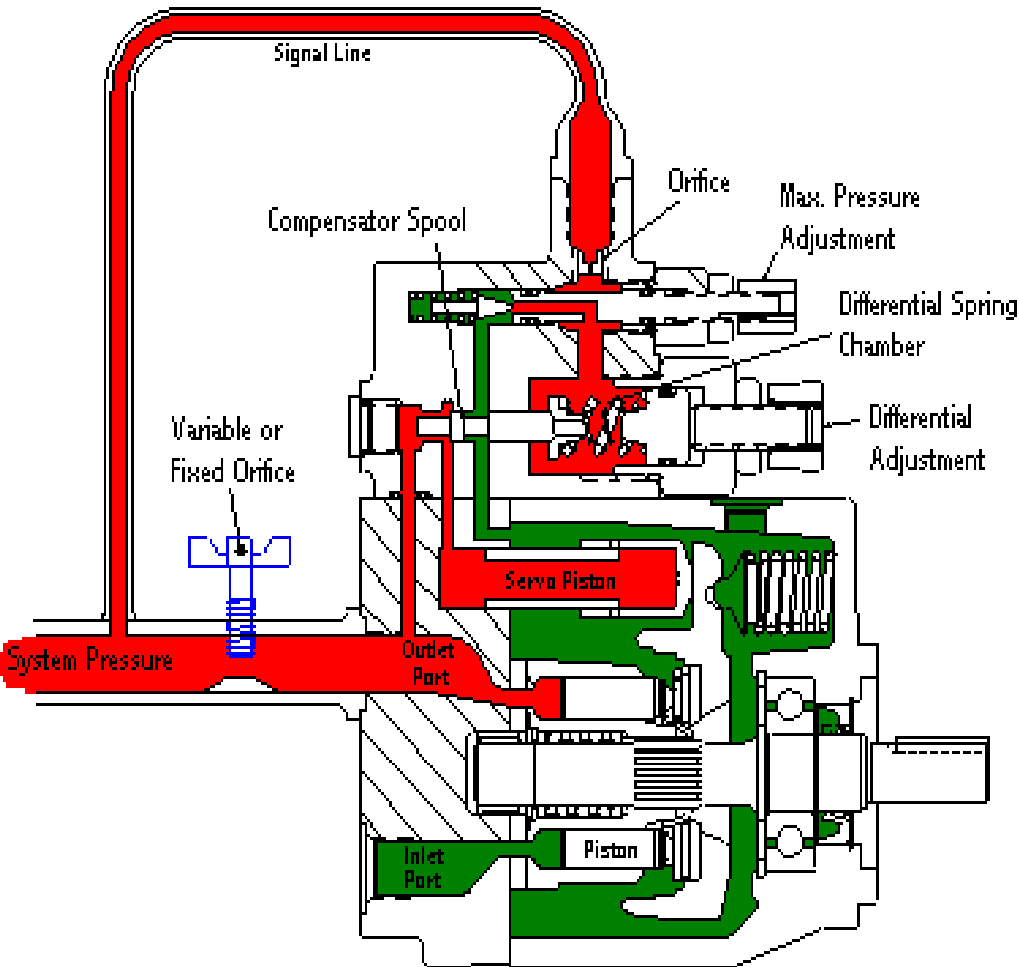

Increasing the pump drive speed will increase the pump output flow, but since the load sense control is working to maintain a constant pressure drop across the orifice, the load sense pump will destroke to maintain the same output flow.

Therefore, in a load sense circuit, the pump will maintain the same output flow, independent of pump drive speed.

# Load Sense Control

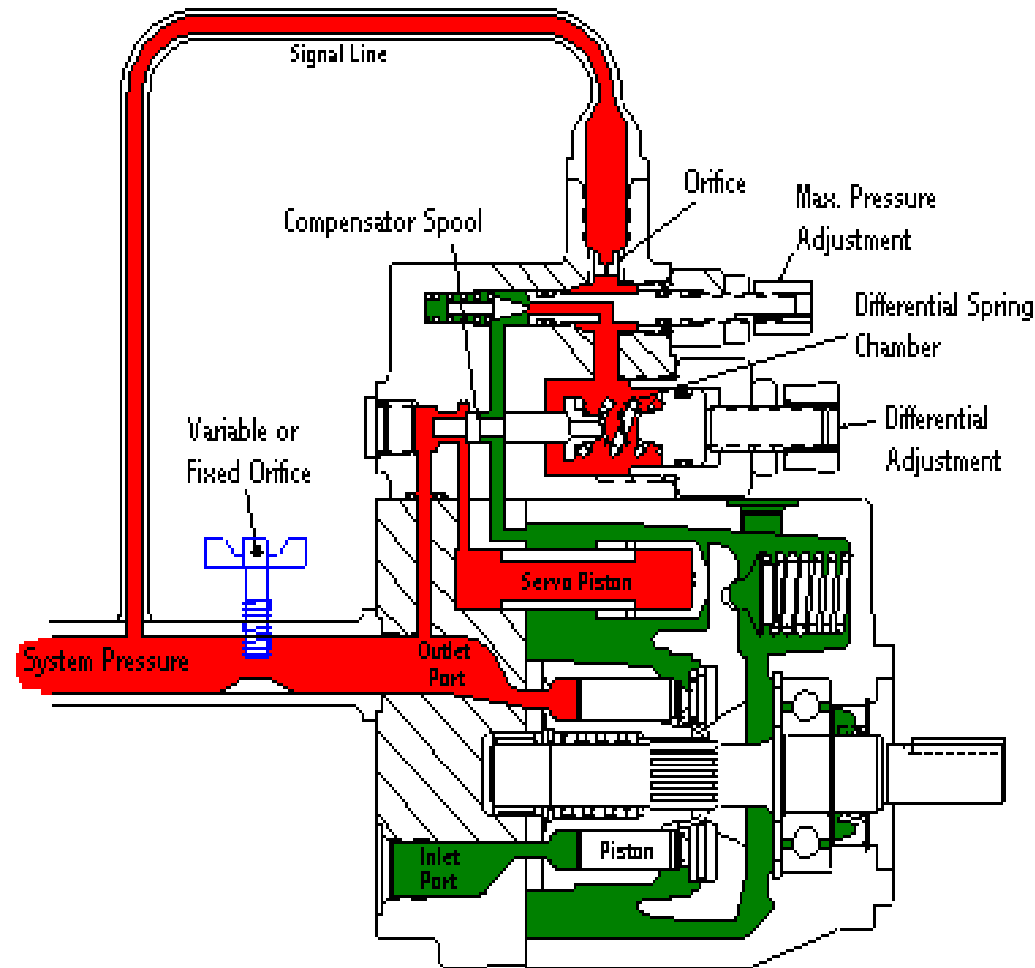

If the load pressure increases, the pump outlet pressure will increase proportionately to maintain the constant pressure drop across the orifice.

Fortunately most load sense controls also incorporate a pressure limiter feature which limits the maximum pressure the pump will achieve.

Once the load pressure reaches the setting of the max pressure spring, the poppet unseats and limits the pressure in the differential spring chamber. As outlet pressure increases it will shift the spool and destroke the pump.

## ***Good things to Know***

- Typical Load Sense Delta P setting is around 200- 300 psi
- Standby Pressure is the pressure level the pump will maintain with no load sense signal. This is typically 50-100 psi higher than the Load Sense Delta P setting
- Higher LS spring setting = faster response, but lower system efficiency
- The load sense bleed option will vent the load sense signal to allow the pump to go to low pressure standby when there is no flow demand. This function is typically and best accomplished in the load sense system valve, but if the system valve does not have this feature, it can be ordered in the pump. The disadvantage of having the bleed in the pump is that there is a continuous loss of this bleed flow through the pump control even when the pump is operating normal.

## Problem

**10 GPM Load Sense Pump**

**Pressure Compensator set at 3000 PSI**

**Load Sense Differential set at 200 PSI**

**Relief Valve Set at 3200 PSI**

**Flow Control Set for 5 GPM**

**Load Pressure is 2000 PSI**

**What is the horsepower being consumed while the cylinder is extending ?**

**How much horsepower is being wasted ?**

**$(HP = GPM * PSI / 1714$**

***assume 100 % efficiency)***

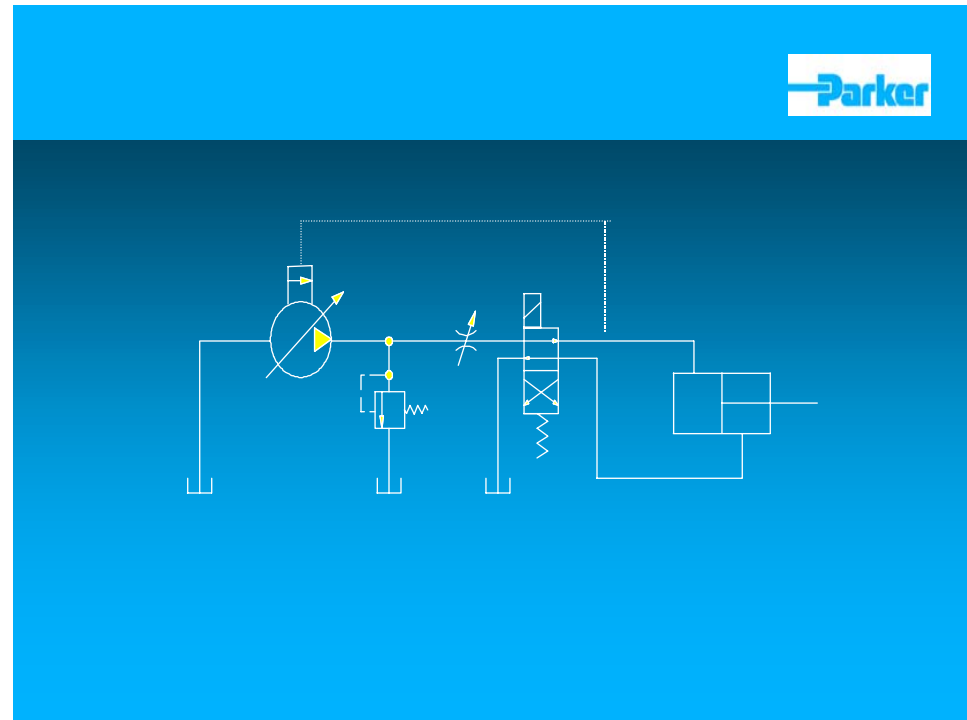

## Problem

**10 GPM Load Sense Pump**

**Pressure Compensator set at 3000 PSI**

**Load Sense Differential set at 200 PSI**

**Relief Valve Set at 3200 PSI**

**Flow Control Set for 5 GPM**

**Load Pressure is 2000 PSI**

**What is the horsepower being consumed while the cylinder is extending ?**

$$5 \text{ GPM} * 2200 \text{ PSI} / 1714 = 6.4 \text{ HP}$$

**How much horsepower is being wasted ?**

$$5 \text{ GPM} * 200 \text{ PSI} / 1714 = .6 \text{ HP}$$

$$(HP = GPM * PSI / 1714$$

*assume 100 % efficiency)*

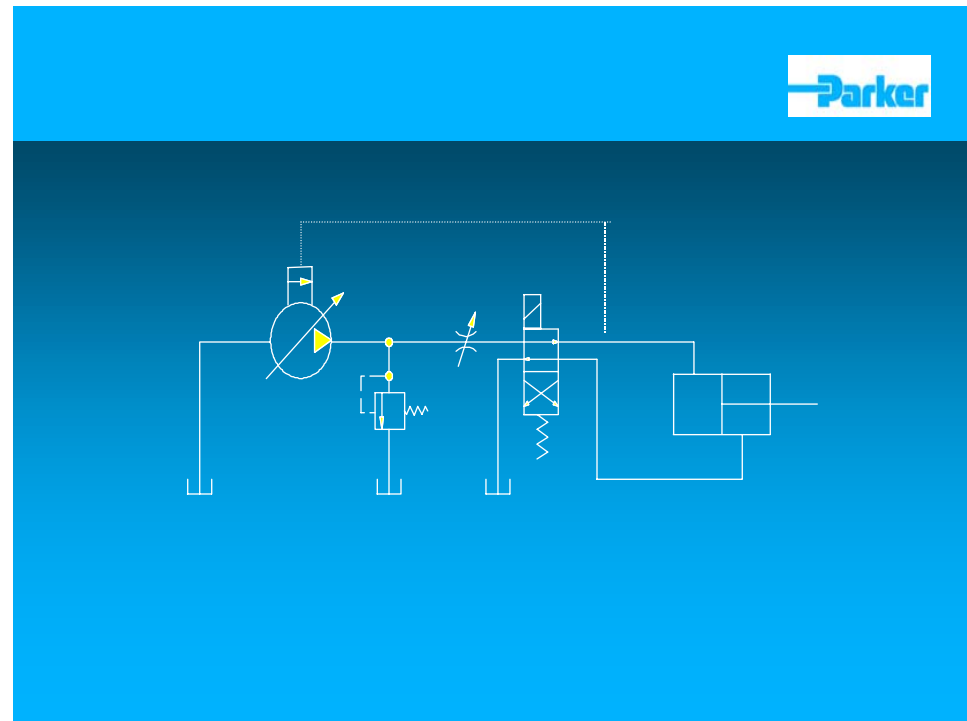

## Problem

**10 GPM Load Sense Pump**

**Pressure Compensator set at 3000 PSI**

**Load Sense Differential set at 200 PSI**

**Relief Valve Set at 3200 PSI**

**Flow Control Set for 5 GPM**

**Load Pressure is 2000 PSI**

**What is the horsepower being consumed while the cylinder is extending ?**

$$5 \text{ GPM} * 2200 \text{ PSI} / 1714 = 6.4 \text{ HP}$$

**How much horsepower is being wasted ?**

$$5 \text{ GPM} * 200 \text{ PSI} / 1714 = .6 \text{ HP}$$

$$(HP = GPM * PSI / 1714$$

*assume 100 % efficiency)*

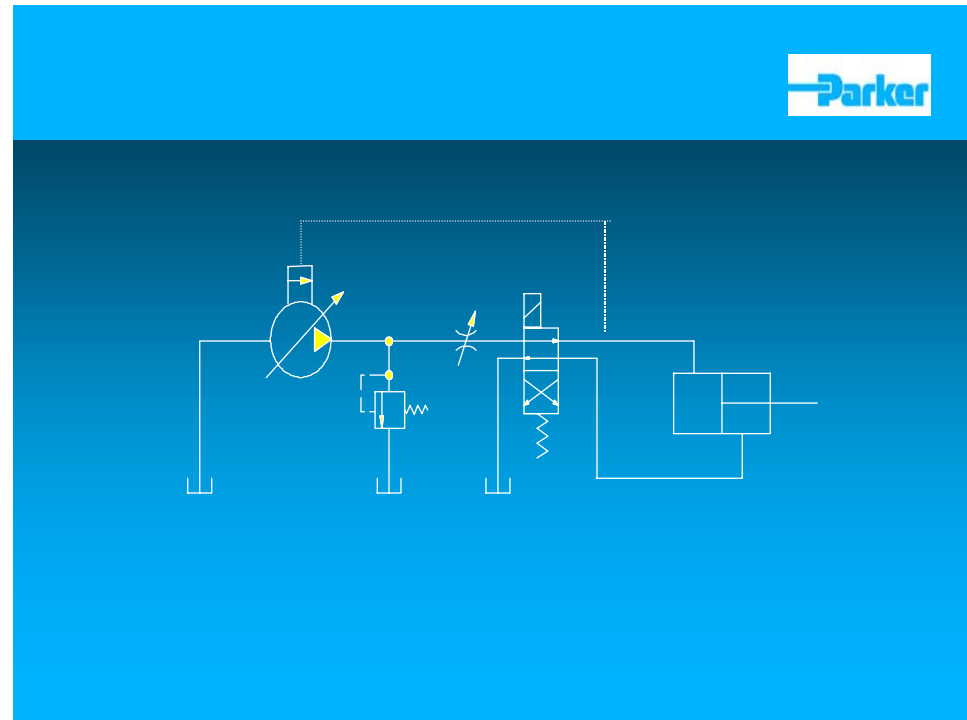

**Remember the Pressure Compensator system used 8.7 HP and wasted 2.9 HP**

# Load Sense Control

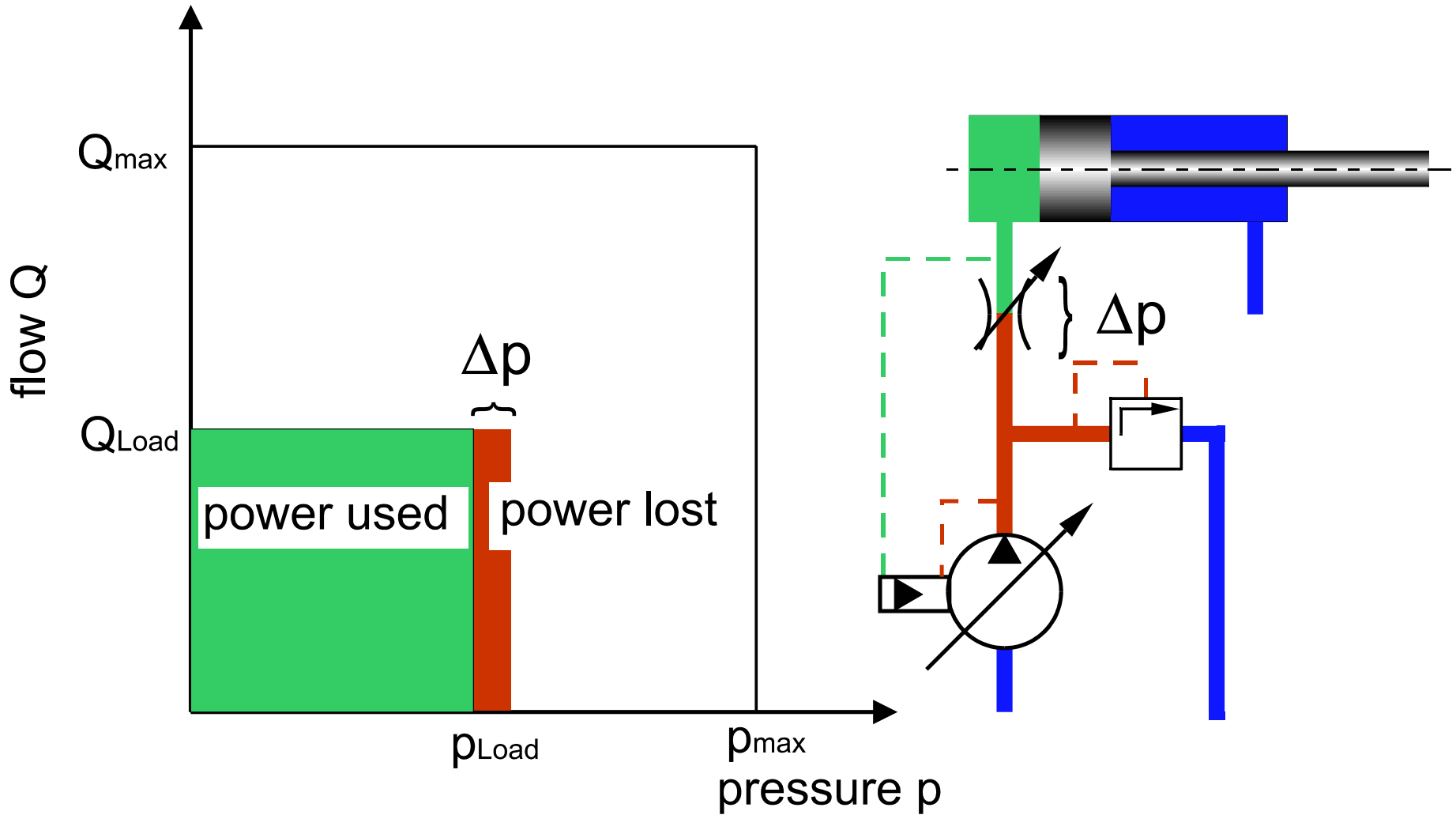

## ***When does Load Sense Make Sense ?***

- When there is a wide variation in flow requirements,
- When there is a wide variation in pressure requirements .
- When there is a need for constant flow , with variable input speed.



## ***What is a Torque Limiter Control ?***

***A torque limiter control will vary pump displacement so that a desired maximum input torque level to the pump is maintained. Typically this desired torque level is the maximum torque available for the hydraulic functions on a machine...the intent is to have the pump controlled to use the input power available most efficiently... when high force is needed the pump will provide high pressure; when high speed is needed the pump will provide high flow.***



*Torque Limiter Control is also referred to as a Horsepower Control in constant input speed systems*

- $HP = (PSI \times CIR \text{ Displacement} \times RPM) / 395934$
- Torque ( ft. lbs.) = ( PSI x CIR Displacement) / 75.36
  - ( Does not vary with changes in speed)
- Direct Relationship Between Horsepower and Torque, so with a constant speed , an input torque limiter control is also an input horsepower limiter control.
- Though the terms Torque Limiter Control and Horsepower Control are used interchangeably, typically it is called a Horsepower Control in Industrial systems and a Torque Control in Mobile systems

- A torque limiter control will adjust the swashplate angle as load pressure changes, to maintain a constant input torque.  $\text{ft.lbs.} = (\text{psi} \times \text{cir}) / 75.36$
- as swashplate angle (flow) increases, the torque limiter pressure setting will decrease. At lower swashplate angles, torque limiter pressure settings increase. The result is that a smaller prime mover can be used to provide the torque needed to turn the pump.

# Torque Limiter Control Characteristics

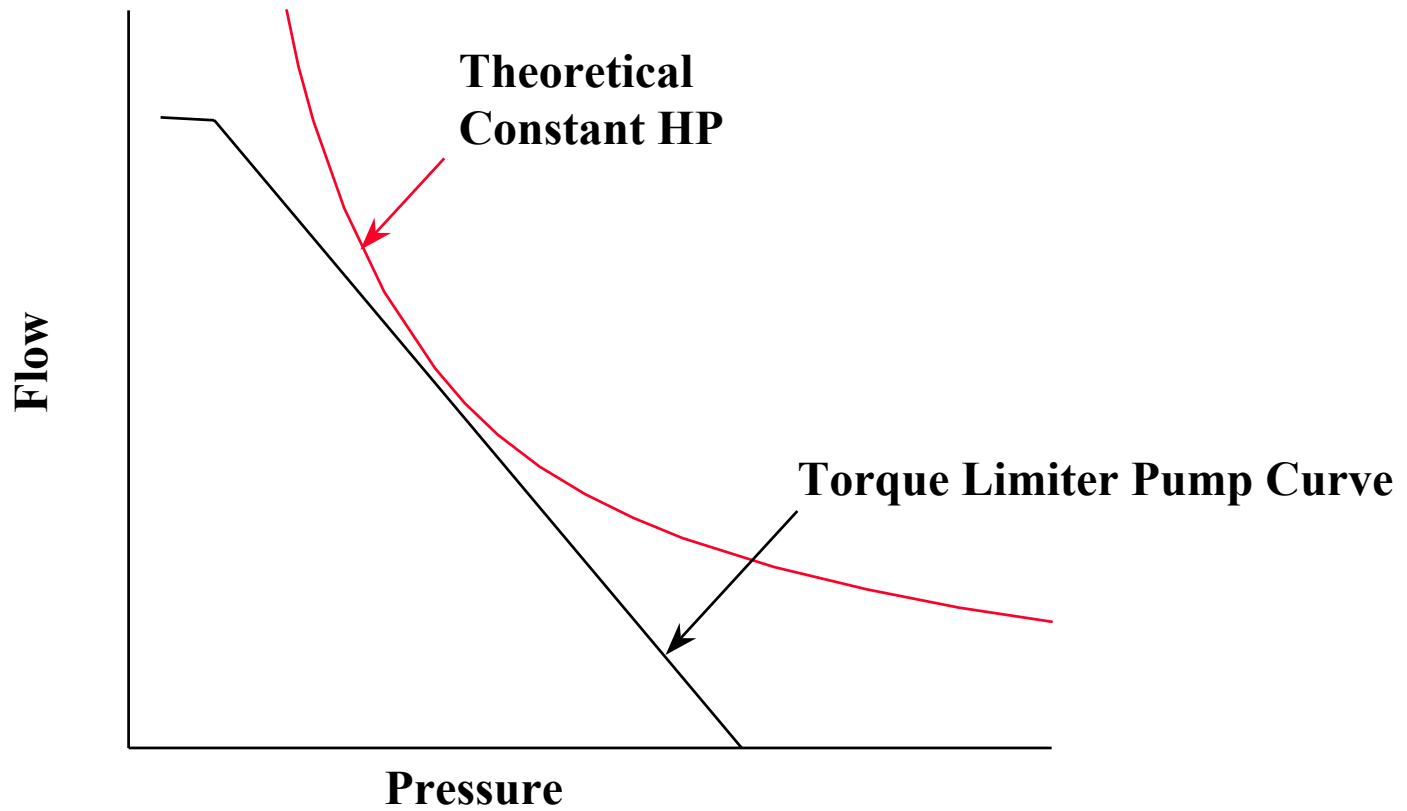

# Torque Limiter Control Characteristics

## Extra Flow and Pressure Available with Torque Control

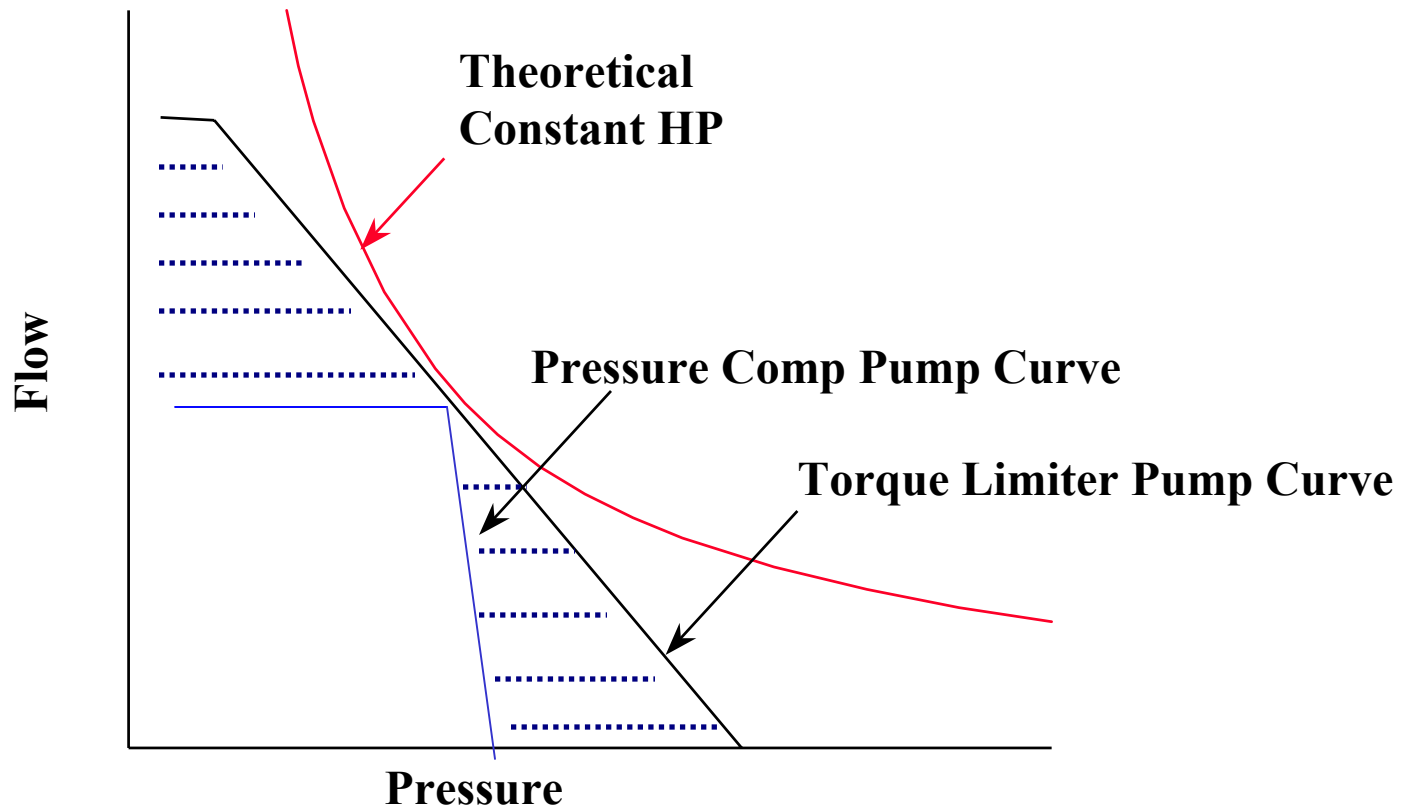

# Torque Limiter Control

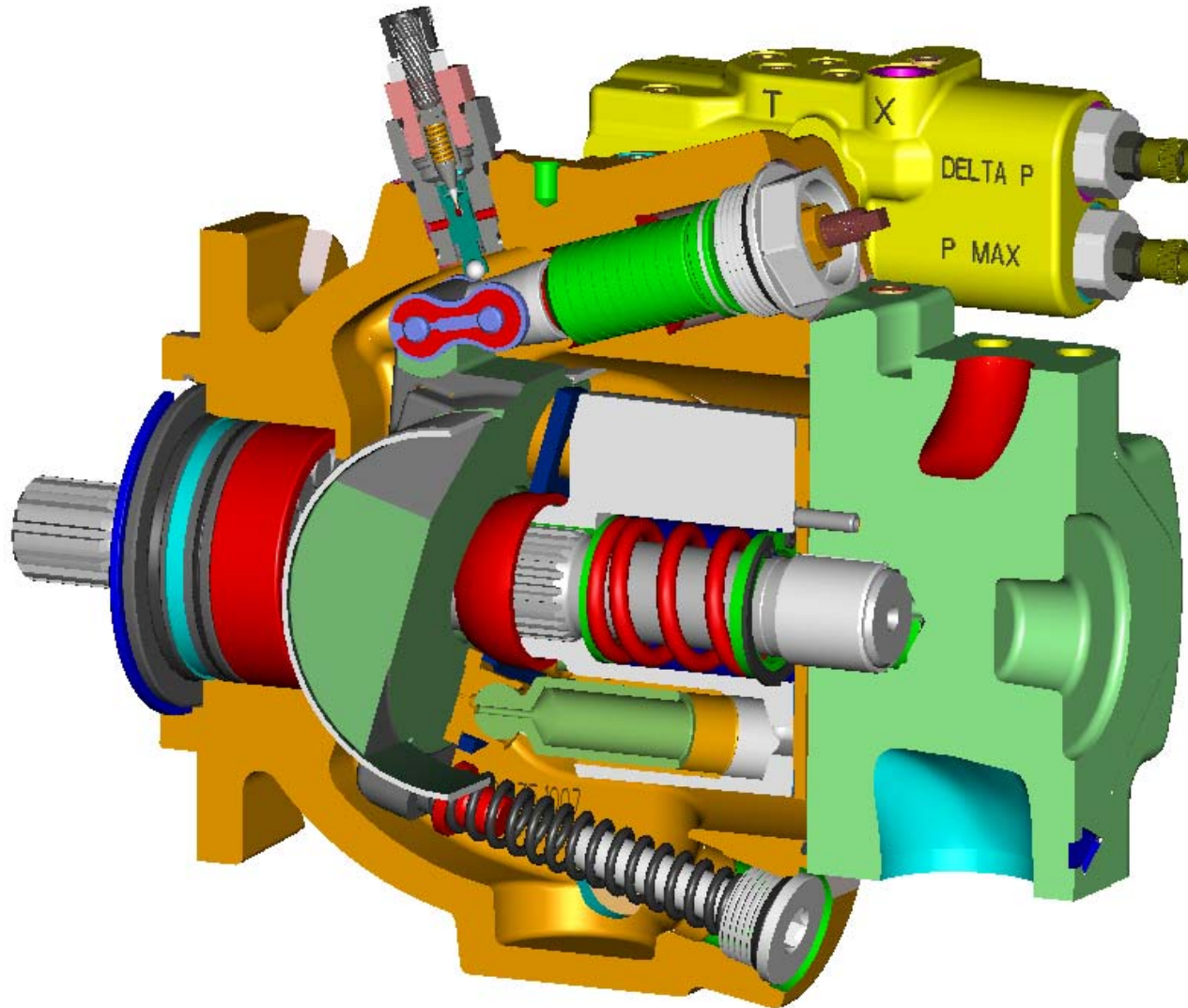

# Torque Limiter Control

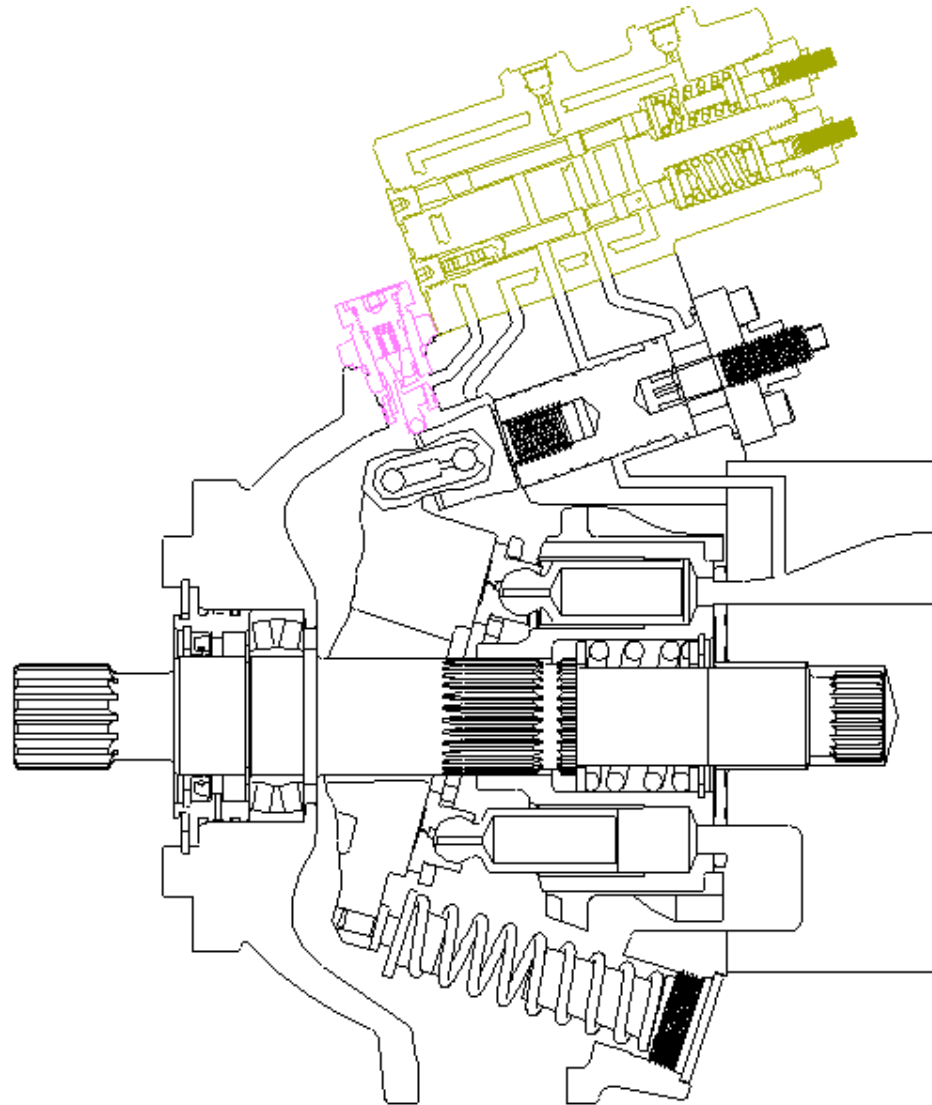

# Torque Limiter Control

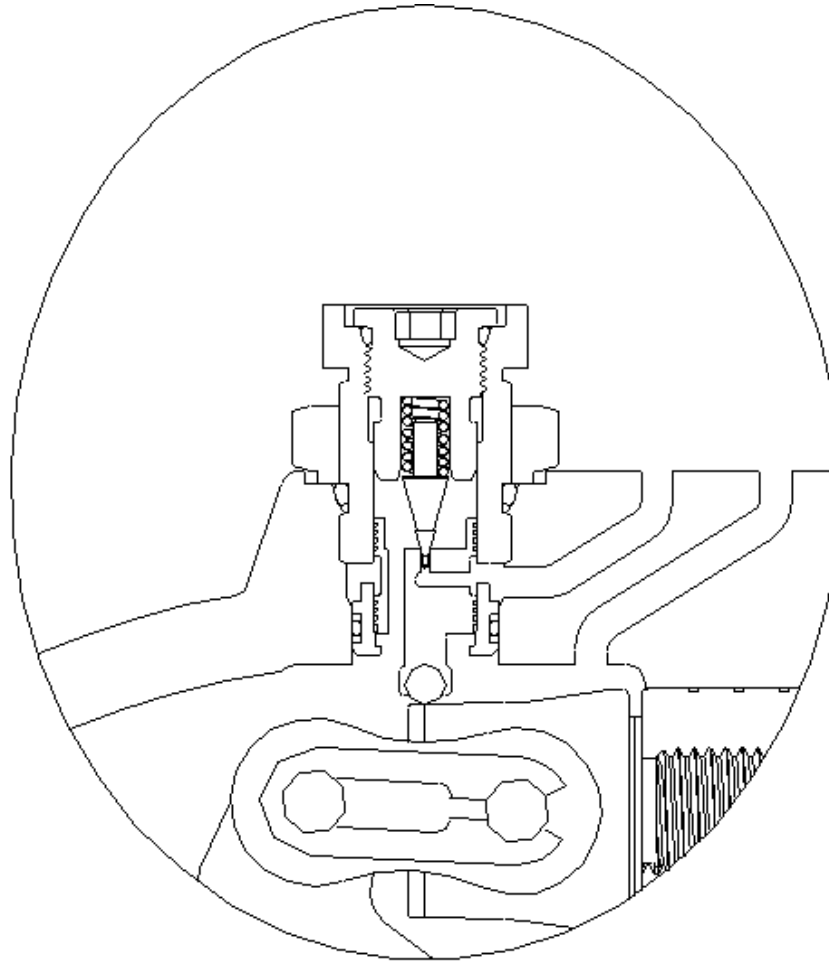



## Control Schematic Color Legend

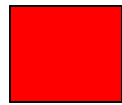

Pump outlet pressure

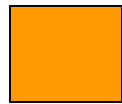

Load Sense signal pressure

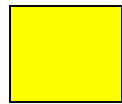

Balance pressure (Steady state)

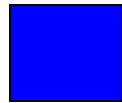

Tank pressure

# Torque Limiter Control

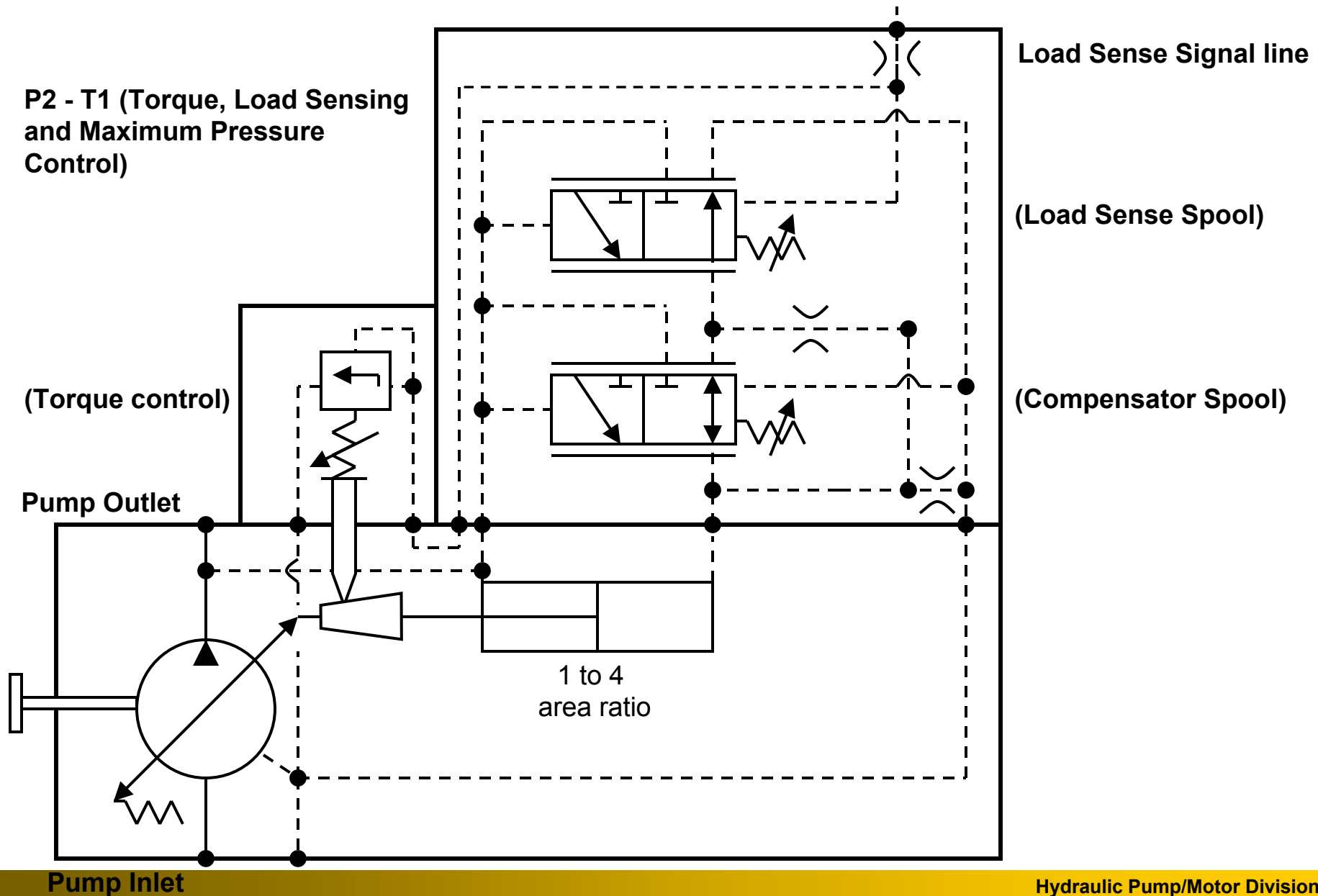



# Torque Limiter Control

P2 - T1 (Torque, Load Sensing and Maximum Pressure Control) Destroke

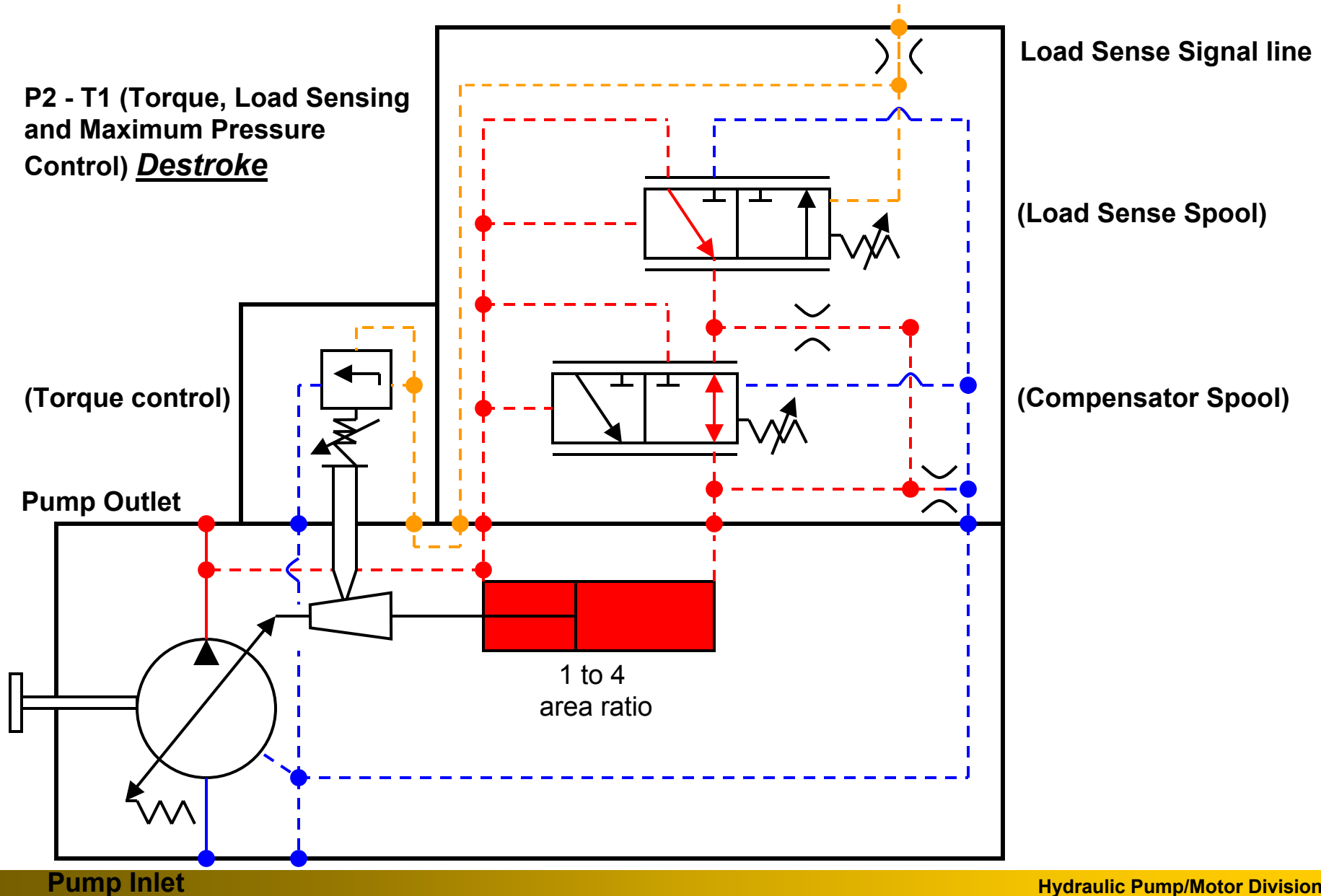

# Torque Limiter Control

P2 - T1 (Torque, Load Sensing and Maximum Pressure Control) On stroke

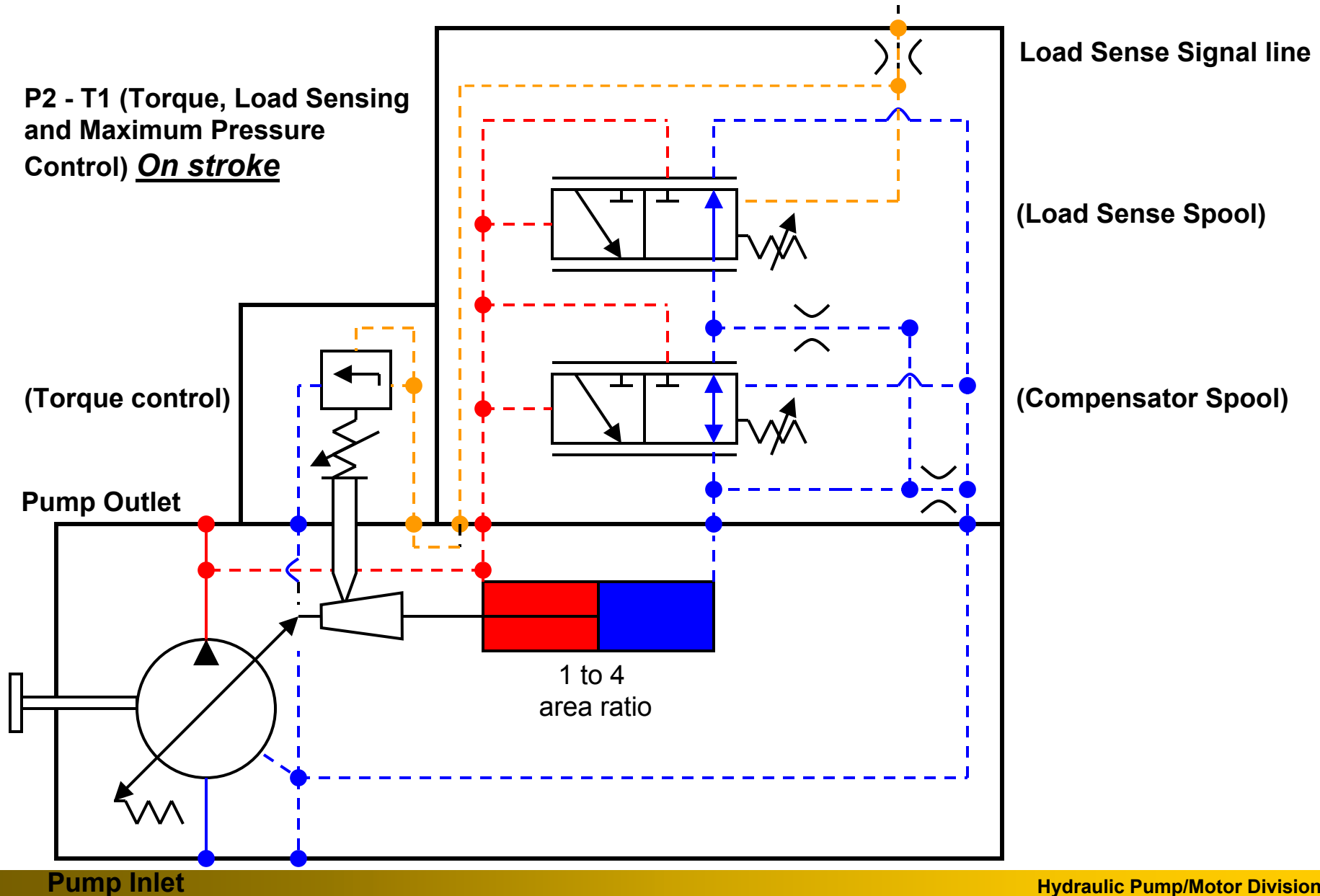

# Torque Limiter Control

P2 - T1 (Torque, Load Sensing and Maximum Pressure Control) Compensator functioning

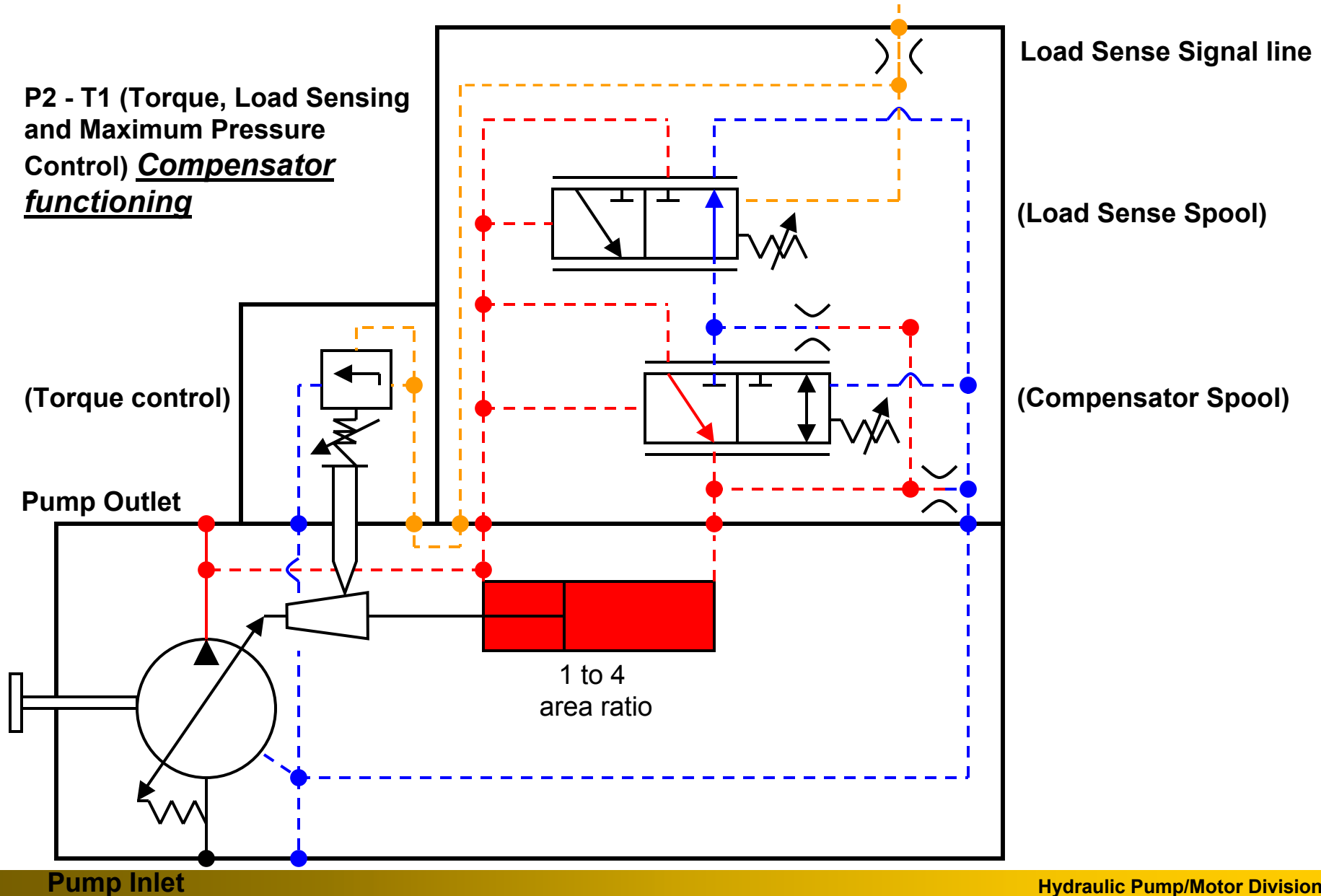

## Problem

**10 GPM Load Sense Pump @ 1800 RPM**

**Pressure Compensator set at 3000 PSI**

**Load Sense Differential set at 200 PSI**

**Relief Valve Set at 3200 PSI**

**Flow Control Set for 5 GPM**

**Load Pressure is 2000 PSI**

**What is the horsepower being consumed while the cylinder is extending ?**

$$5 \text{ GPM} * 2200 \text{ PSI} / 1714 = 6.4 \text{ HP}$$

**How much horsepower is being wasted ?**

$$5 \text{ GPM} * 200 \text{ PSI} / 1714 = .6 \text{ HP}$$

**If there is only 5 horsepower available, what is the maximum pressure that can be achieved with this circuit before the prime mover stalls?**

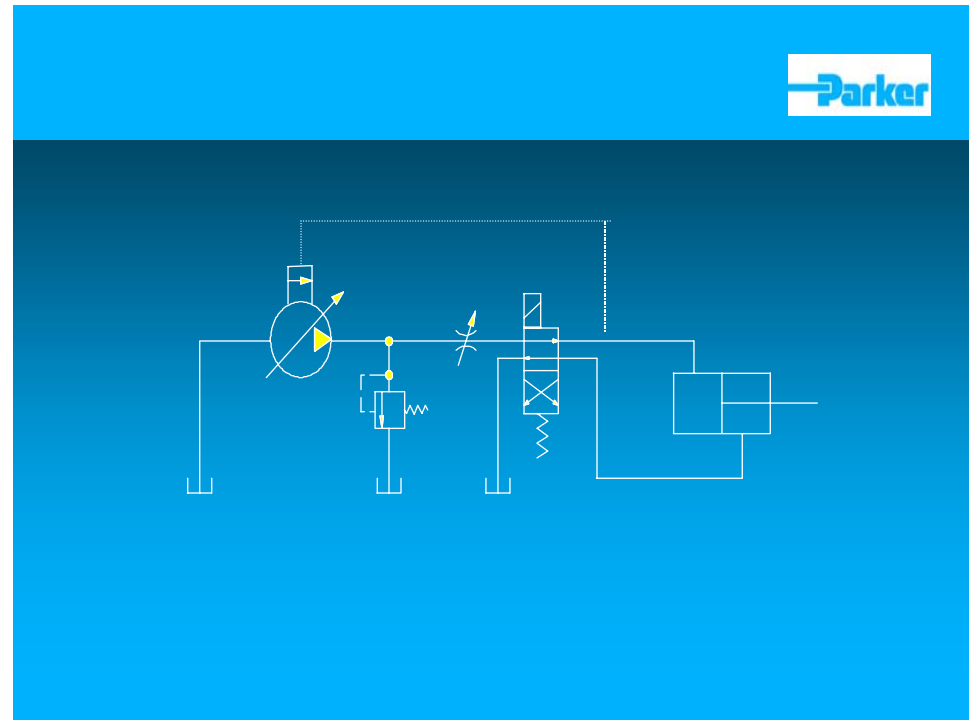

**(HP = GPM \* PSI / 1714  
assume 100 % efficiency)**

## Problem

**10 GPM Load Sense Pump @ 1800 RPM**

**Pressure Compensator set at 3000 PSI**

**Load Sense Differential set at 200 PSI**

**Relief Valve Set at 3200 PSI**

**Flow Control Set for 5 GPM**

**Load Pressure is 2000 PSI**

**What is the horsepower being consumed while the cylinder is extending ?**

$$5 \text{ GPM} * 2200 \text{ PSI} / 1714 = 6.4 \text{ HP}$$

**How much horsepower is being wasted ?**

$$5 \text{ GPM} * 200 \text{ PSI} / 1714 = .6 \text{ HP}$$

**If there is only 5 horsepower available, what is the maximum pressure that can be achieved with this circuit before the prime mover stalls?**

$$5 / 6.4 * 2200 \text{ psi} = 1720 \text{ psi} \dots$$

**1520 psi to the load**

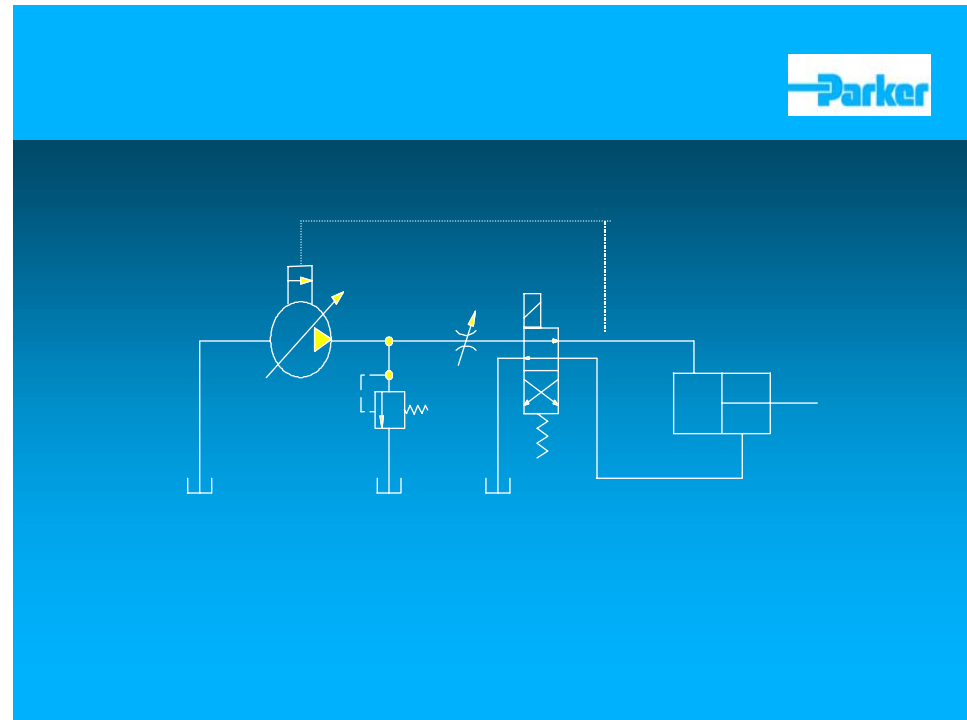

**(HP = GPM \* PSI / 1714  
assume 100 % efficiency)**



## Problem

**10 GPM @ 1800 RPM Torque Control Load Sense Pump**

**Pressure Compensator set at 3000 PSI**

**Load Sense Differential set at 200 PSI**

**System Valve Set for 5 GPM**

**5 HP @ 1800 RPM Available**

**5HP \* 63024 / 1800 = 175 in.lbs. Available**

**With the torque limiter control, what is the maximum load pressure that can be achieved with the cylinder extending at 3 GPM ?**

**(Remember it achieved 1520 psi at 5 GPM)**

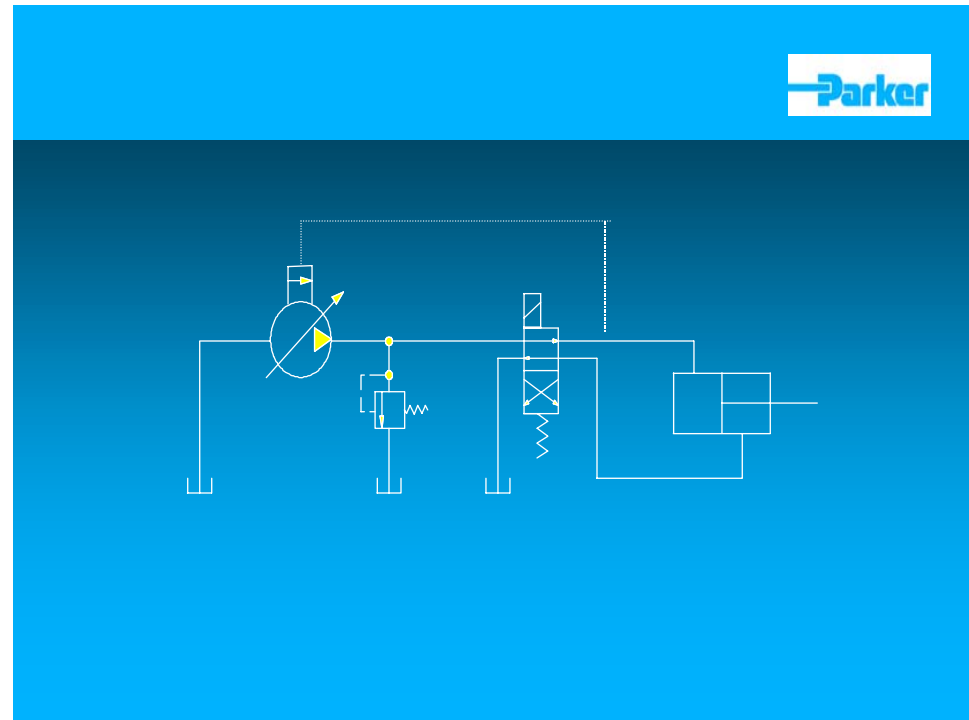

$$\text{Torque In. Lbs} = (\text{CIR} * \text{PSI}) / 905$$

$$(\text{HP} = \text{GPM} * \text{PSI} / 1714$$

**assume 100 % efficiency)**

## Problem

**10 GPM @ 1800 RPM Torque Control Load Sense Pump**

**Pressure Compensator set at 3000 PSI**

**Load Sense Differential set at 200 PSI**

**System Valve Set for 5 GPM**

**5 HP @ 1800 RPM Available**

**5HP \* 63024 / 1800 = 175 in.lbs. Available**

**With the torque limiter control, what is the maximum load pressure that be achieved with the cylinder extending at 3 GPM ?**

**(Remember it achieved 1520 psi at 5 GPM)**

$$5/3 * 1520 = 2533 \text{ psi}$$

**Using Torque control  
increased force potential**

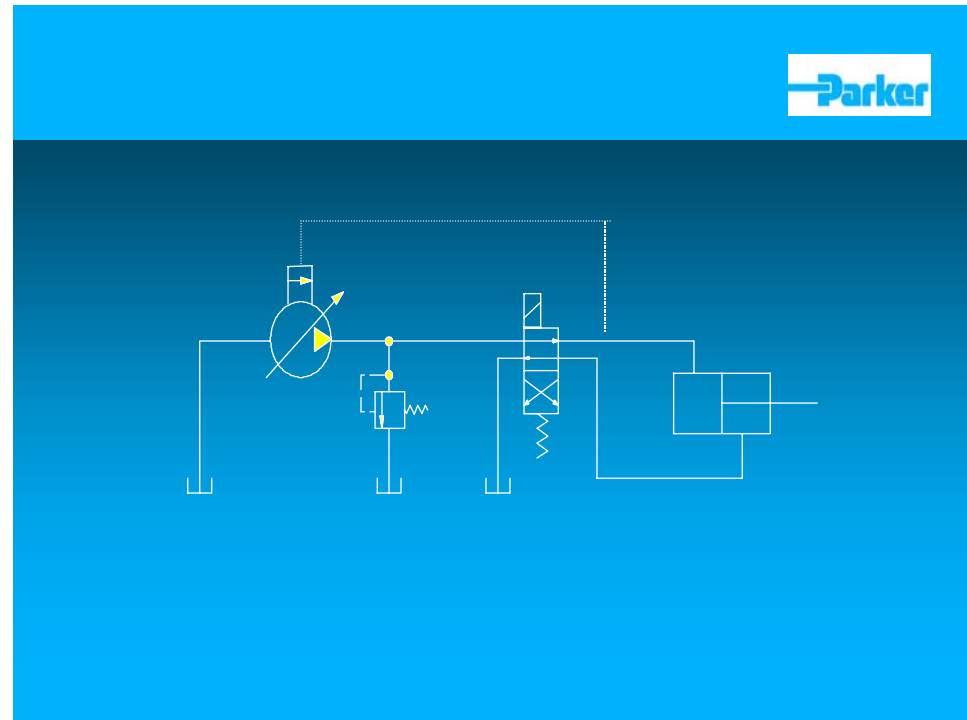

$$\text{Torque In. Lbs} = (\text{CIR} * \text{PSI}) / 905$$

$$(\text{HP} = \text{GPM} * \text{PSI} / 1714$$

**assume 100 % efficiency)**

## ***When does a Torque Limiter Make Sense ?***

- **When a consistent percentage of the engine power is available for the pump functions.**
- **When there is a variation in flow and pressure requirements, such that at some points high pressure/low flow is needed and at other times low pressure/high flow is needed.**

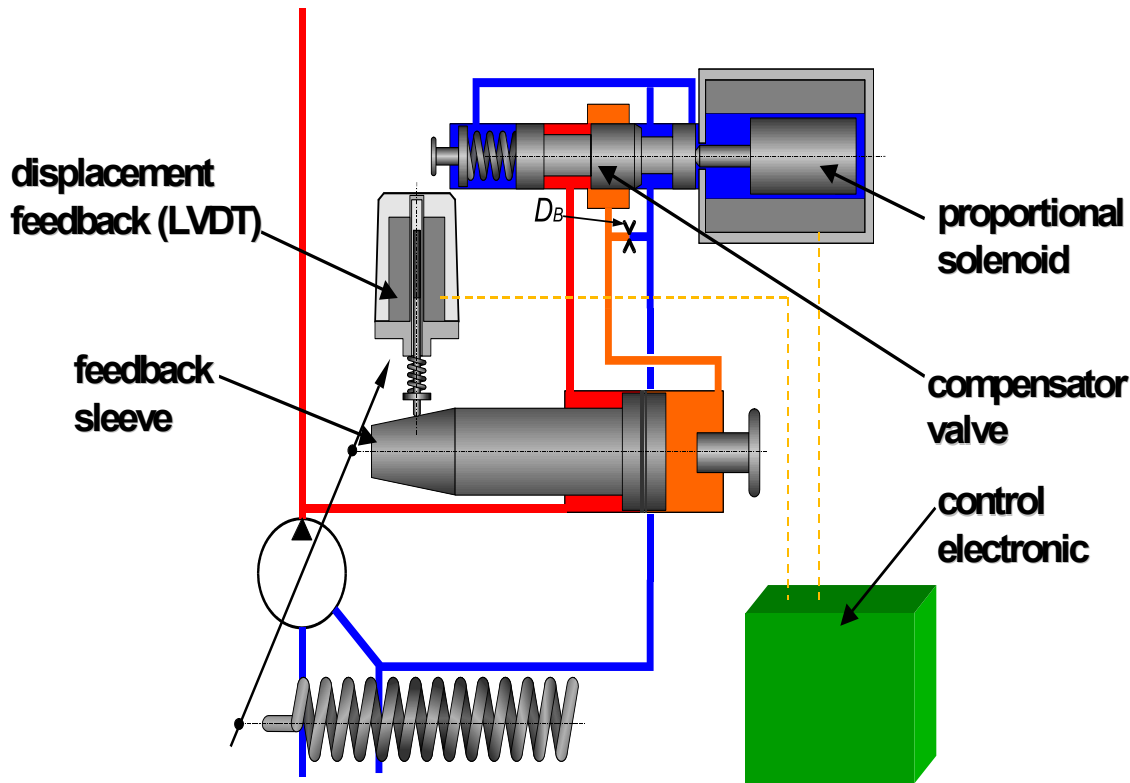

A proportional displacement control will position the washplate angle proportional to a input voltage signal to the solenoid. The output flow can be adjusted , without affect from system pressure. A LVDT feedback signal of the washplate angle closes the loop electronically. An amplifier card in the electronic controller compares the command signal and the feedback signal and sends a voltage signal to the proportional solenoid to position the washplate.

A Pressure compensator function is included which will destroke the pump when the compensator pressure setting is reached.

## Proportional Displacement Control

The Proportional Displacement control will increase or decrease the output flow in response to an input voltage signal. Like a load sense control, the proportional displacement control will provide just the flow demanded, regardless of system pressure changes. The advantage over load sensing is that there is no differential pressure loss with this control.

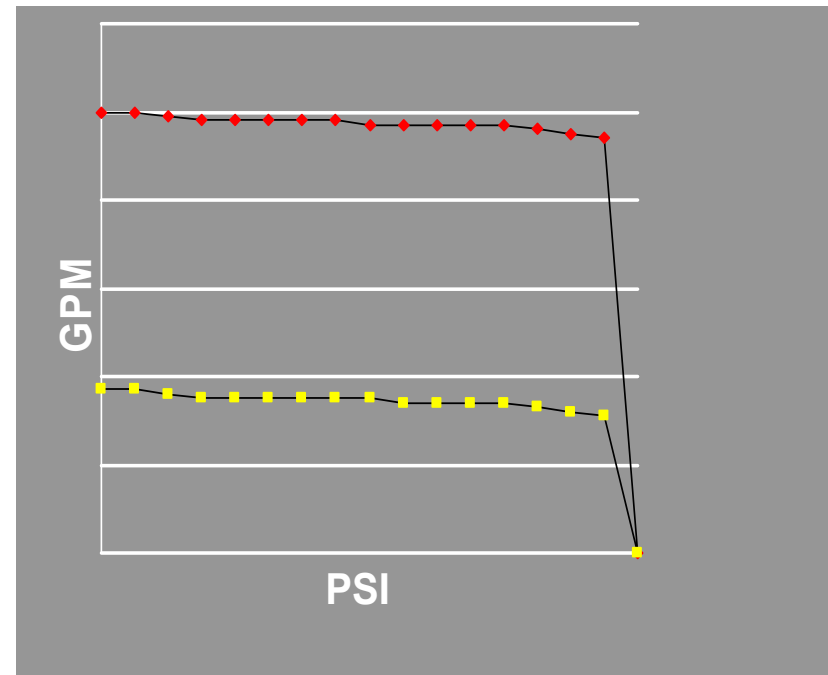

## Problem

**10 GPM Pump with Proportional Displacement Control**

**Pressure Compensator set at 3000 PSI**

**Relief Valve Set at 3200 PSI**

**Load Pressure is 2000 PSI**

**What is the horsepower being consumed while the cylinder is extending ?**

**How much horsepower is being wasted ?**

**$(HP = GPM * PSI / 1714$**

***assume 100 % efficiency)***

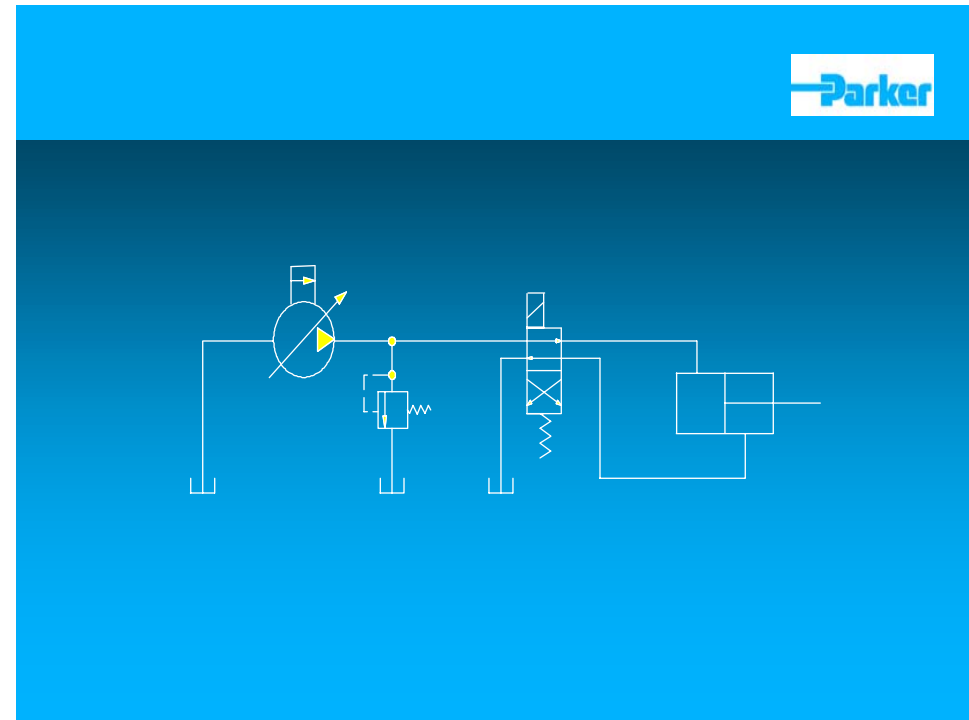

## Problem

**10 GPM Pump with Proportional Displacement Control**

**Pressure Compensator set at 3000 PSI**

**Relief Valve Set at 3200 PSI**

**Load Pressure is 2000 PSI**

**What is the horsepower being consumed while the cylinder is extending ?**

$$5 \text{ GPM} * 2000 \text{ PSI} / 1714 = 5.8 \text{ HP}$$

**How much horsepower is being wasted ?**

**Very little , just pressure drop across the directional valve , assume 25 psi**

$$5 \text{ GPM} * 25 \text{ PSI} / 1714 = .1 \text{ HP}$$

$$(HP = GPM * PSI / 1714$$

**assume 100 % efficiency)**

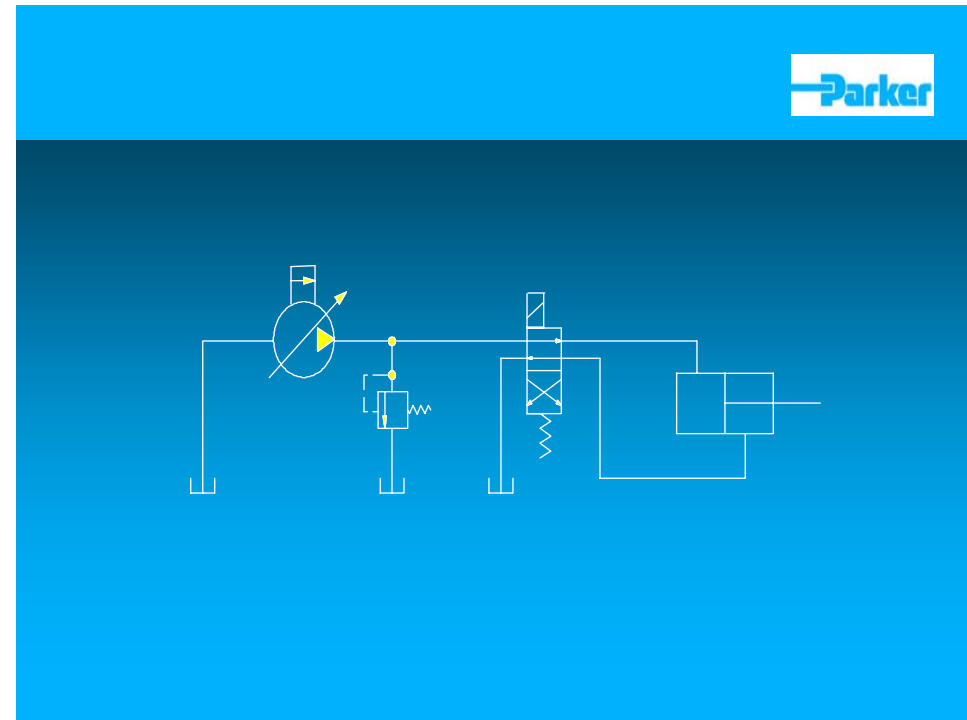

## Problem

**10 GPM Pump with Proportional Displacement Control**

**Pressure Compensator set at 3000 PSI**

**Relief Valve Set at 3200 PSI**

**Load Pressure is 2000 PSI**

**What is the horsepower being consumed while the cylinder is extending ?**

$$5 \text{ GPM} * 2000 \text{ PSI} / 1714 = 5.8 \text{ HP}$$

**How much horsepower is being wasted ?**

**Very little , just pressure drop across the directional valve , assume 25 psi**

$$5 \text{ GPM} * 25 \text{ PSI} / 1714 = .1 \text{ HP}$$

$$(HP = GPM * PSI / 1714$$

*assume 100 % efficiency)*

**Remember the Load Sense system used 6.4 HP and wasted .6 HP**

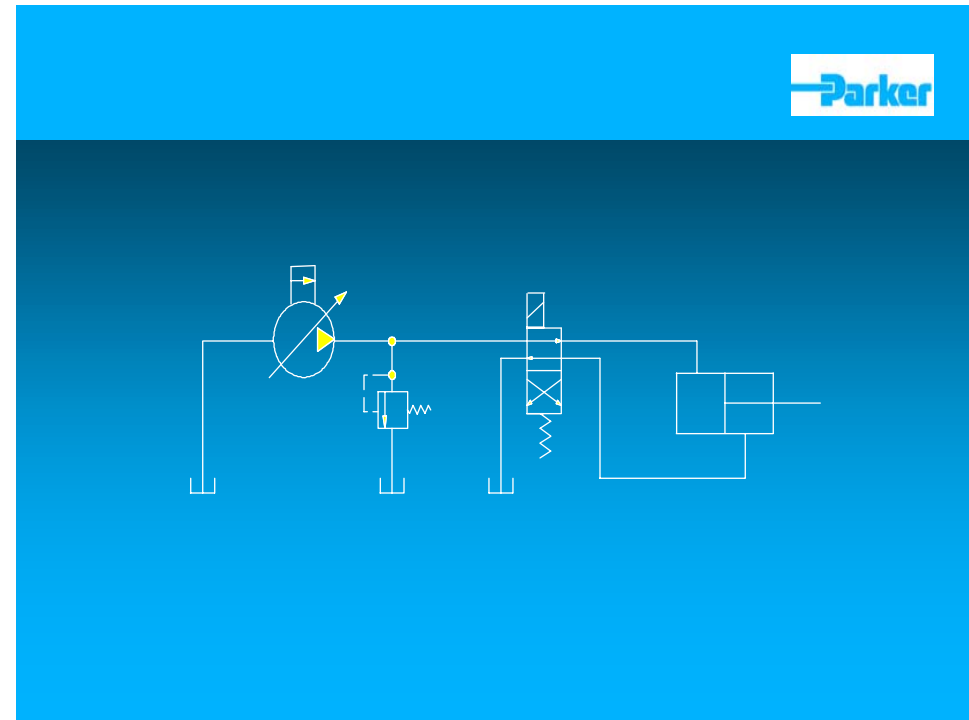



# Power Demand / Energy Savings

