

Physical

Mass	16.0358 kg
Area	671459 mm ²
Volume	2052920 mm ³
Center of Gravity	x=396.108 mm y=596.203 mm z=50 mm

Note: Physical values could be different from Physical values used by FEA reported below.

Static Analysis:1

General objective and settings:

Design Objective	Single Point
Study Type	Static Analysis
Last Modification Date	28-Sep-17, 7:28 AM
Detect and Eliminate Rigid Body Modes	No
Separate Stresses Across Contact Surfaces	No
Motion Loads Analysis	No

Mesh settings:

Avg. Element Size (fraction of model diameter)	0.1
Min. Element Size (fraction of avg. size)	0.2
Grading Factor	1.5
Max. Turn Angle	60 deg
Create Curved Mesh Elements	No
Use part based measure for Assembly mesh	Yes

Material(s)

Name	Steel, Mild, Welded	
General	Mass Density	7.85 g/cm ³
	Yield Strength	207 MPa
	Ultimate Tensile Strength	345 MPa
Stress	Young's Modulus	220 GPa
	Poisson's Ratio	0.275 ul
	Shear Modulus	86.2745 GPa
Part Name(s)	Assembly1.iam Part1.ipt Part2.ipt Part2.ipt Part3.ipt Part3.ipt	

Operating conditions

Force:1

Load Type	Force
Magnitude	30000.000 N
Vector X	-10772.179 N
Vector Y	-27999.289 N
Vector Z	0.000 N

Selected Face(s)

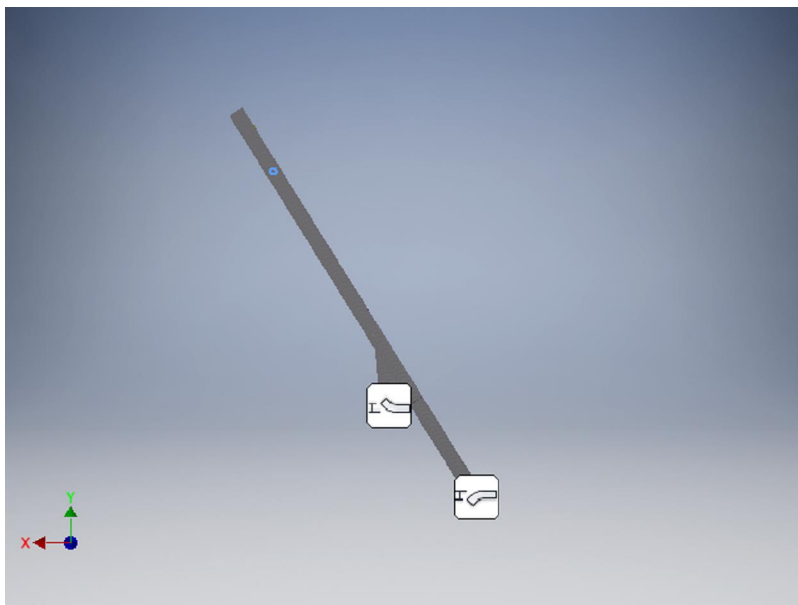

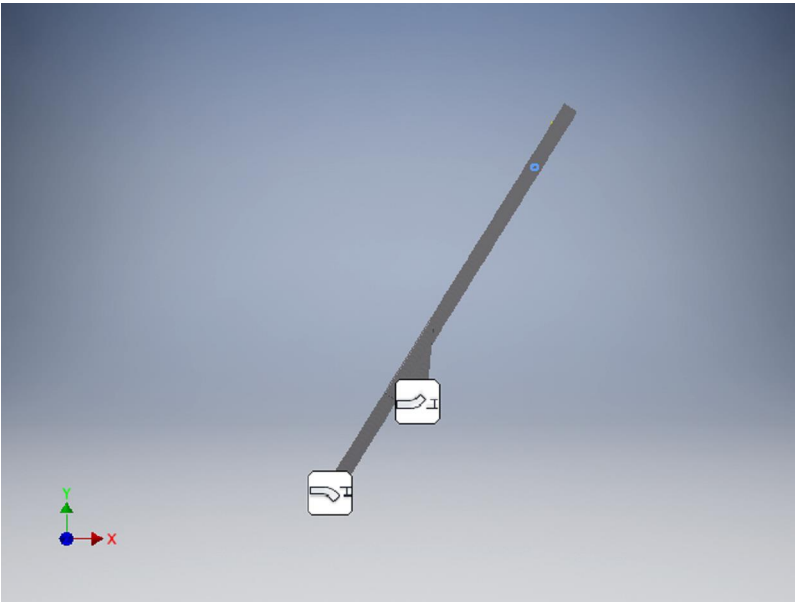

Fixed Constraint:1

Constraint Type Fixed Constraint

Selected Face(s)

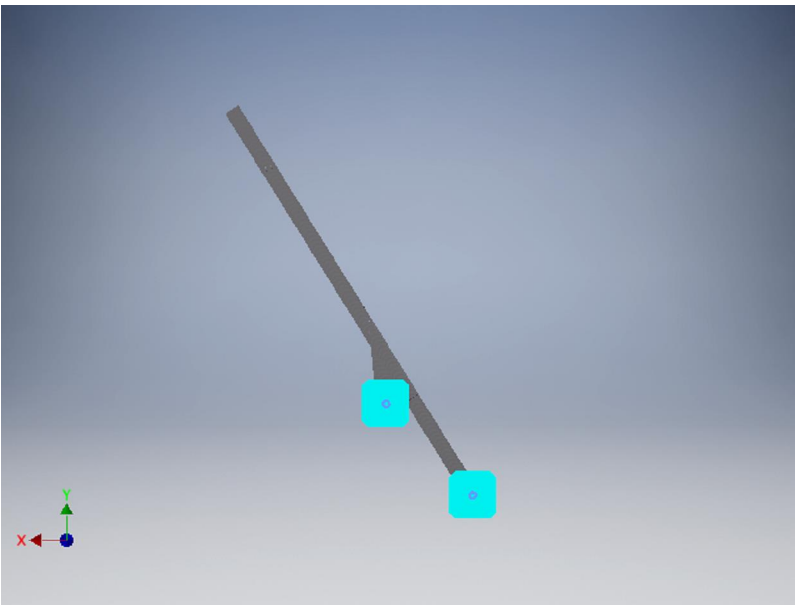

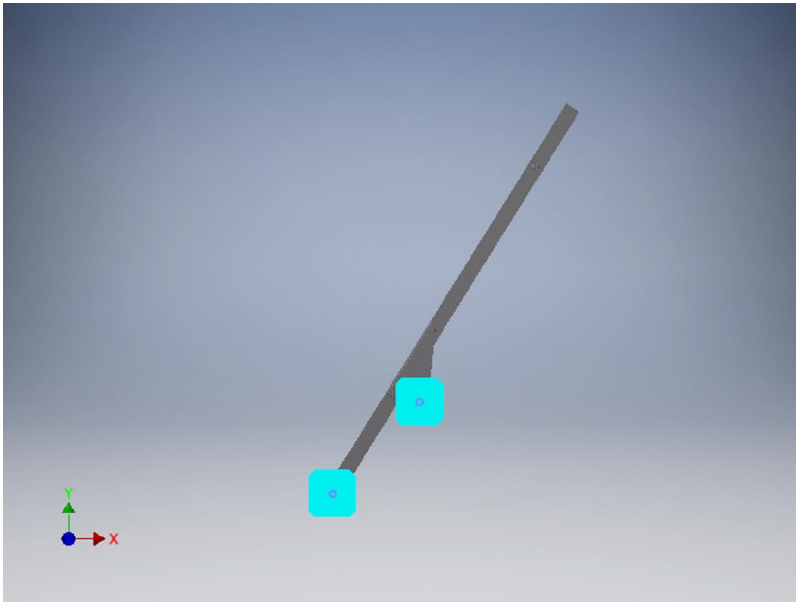

Contacts (Bonded)

Name	Part Name(s)
Bonded:1	Part1:1 Part2:1
Bonded:2	Part1:1 Part2:2
Bonded:3	Welds Welds
Bonded:4	Welds Part1:1
Bonded:5	Welds Part2:1
Bonded:6	Welds Welds
Bonded:7	Welds Part1:1
Bonded:8	Welds Part2:1
Bonded:9	Welds Part2:1
Bonded:10	Welds Part2:1
Bonded:11	Welds Part2:1
Bonded:12	Welds Part1:1
Bonded:13	Welds Part2:2
Bonded:14	Welds Welds
Bonded:15	Welds Welds
Bonded:16	Welds Part1:1
Bonded:17	Welds Part2:2
Bonded:18	Welds Part2:2

Bonded:19 Welds
Part2:2

Bonded:20 Welds
Part2:2

Bonded:21 Welds
Part1:1

Bonded:22 Welds
Part3:2

Bonded:23 Welds
Part1:1

Bonded:24 Welds
Part3:2

Bonded:25 Welds
Part1:1

Bonded:26 Welds
Part3:1

Bonded:27 Welds
Part1:1

Bonded:28 Welds
Part3:1

Results

Reaction Force and Moment on Constraints

Constraint Name	Reaction Force		Reaction Moment	
	Magnitude	Component (X,Y,Z)	Magnitude	Component (X,Y,Z)
Fixed Constraint:1	30000 N	10772.2 N	6625.11 N m	0 N m
		27999.3 N		0 N m
		0 N		6625.11 N m

Result Summary

Name	Minimum	Maximum
Volume	2052920 mm ³	
Mass	16.1154 kg	
Von Mises Stress	0 MPa	494.312 MPa
1st Principal Stress	-98.1667 MPa	533.973 MPa
3rd Principal Stress	-497.567 MPa	61.3426 MPa
Displacement	0 mm	19.2131 mm
Safety Factor	0.418764 ul	15 ul
Stress XX	-263.094 MPa	431.049 MPa
Stress XY	-225.212 MPa	179.578 MPa
Stress XZ	-202.114 MPa	197.719 MPa
Stress YY	-417.587 MPa	244.803 MPa
Stress YZ	-234.625 MPa	223.775 MPa
Stress ZZ	-334.248 MPa	281.891 MPa
X Displacement	-0.0172889 mm	16.4883 mm
Y Displacement	-10.9965 mm	0.0396379 mm
Z Displacement	-0.081046 mm	0.0791512 mm
Equivalent Strain	0 ul	0.00197072 ul
1st Principal Strain	-0.000000053072 ul	0.00201408 ul
3rd Principal Strain	-0.00225353 ul	0 ul
Strain XX	-0.00084414 ul	0.00141759 ul

Strain XY	-0.0013052 ul	0.00104074 ul
Strain XZ	-0.00117134 ul	0.00114587 ul
Strain YY	-0.00159326 ul	0.000809384 ul
Strain YZ	-0.00135976 ul	0.00129688 ul
Strain ZZ	-0.00127097 ul	0.00127792 ul
Contact Pressure	0 MPa	1266.86 MPa
Contact Pressure X	-960.322 MPa	945.719 MPa
Contact Pressure Y	-1004.83 MPa	1232.6 MPa
Contact Pressure Z	-375.972 MPa	363.486 MPa

Figures

Von Mises Stress

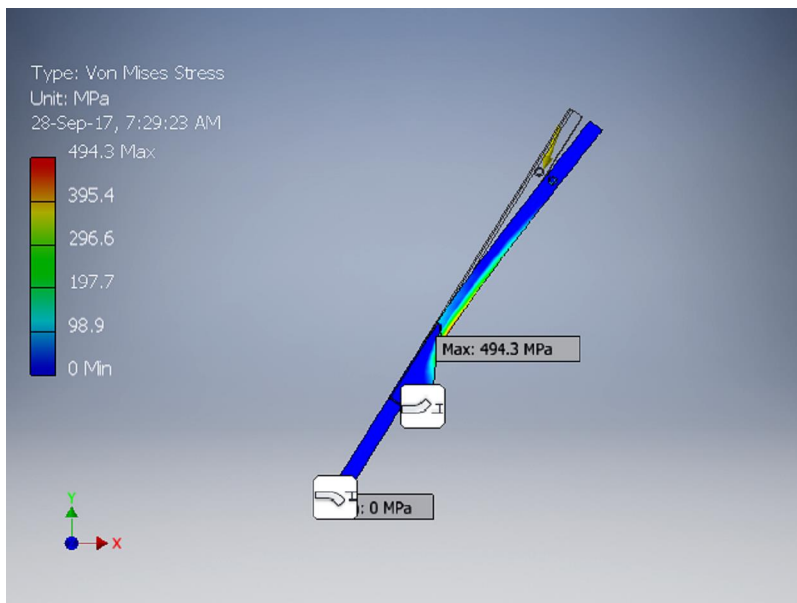
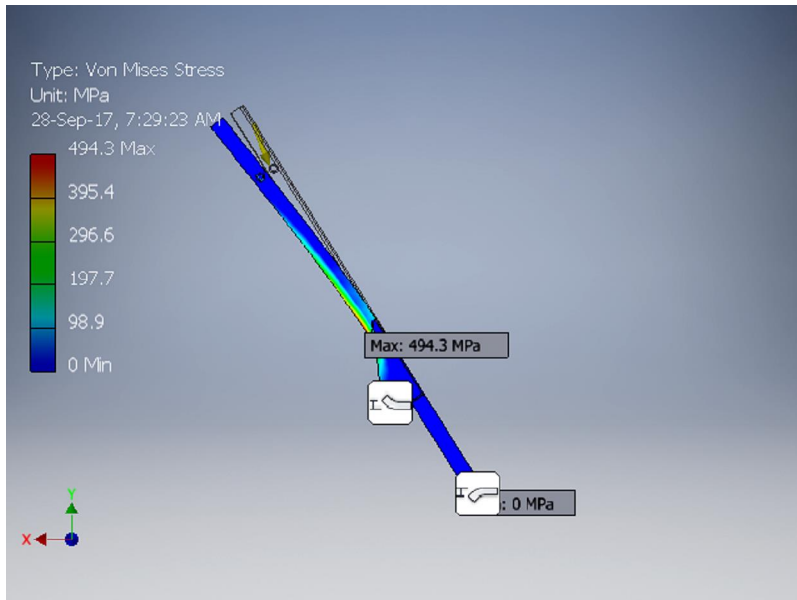

1st Principal Stress

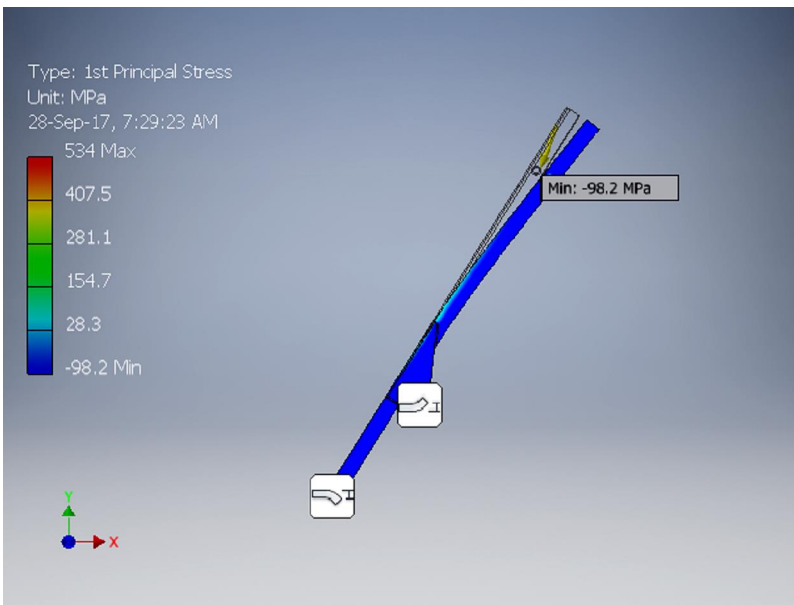
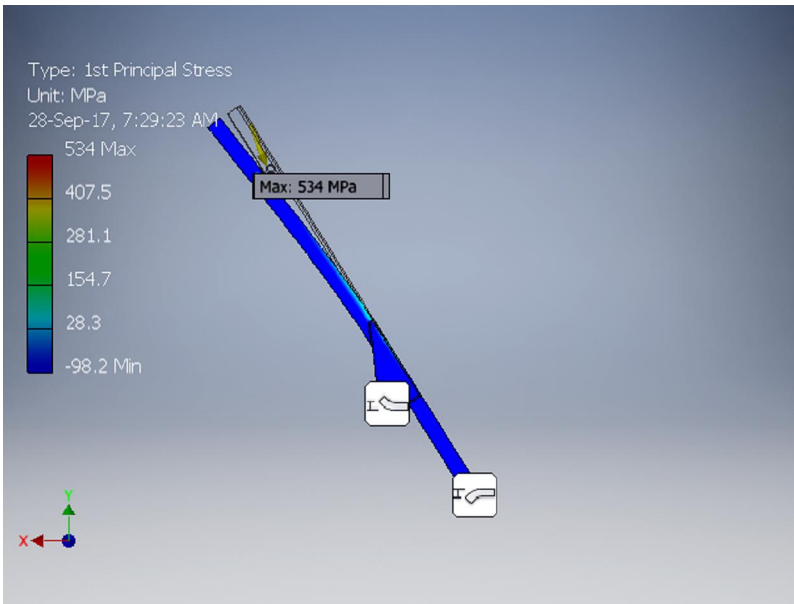

3rd Principal Stress

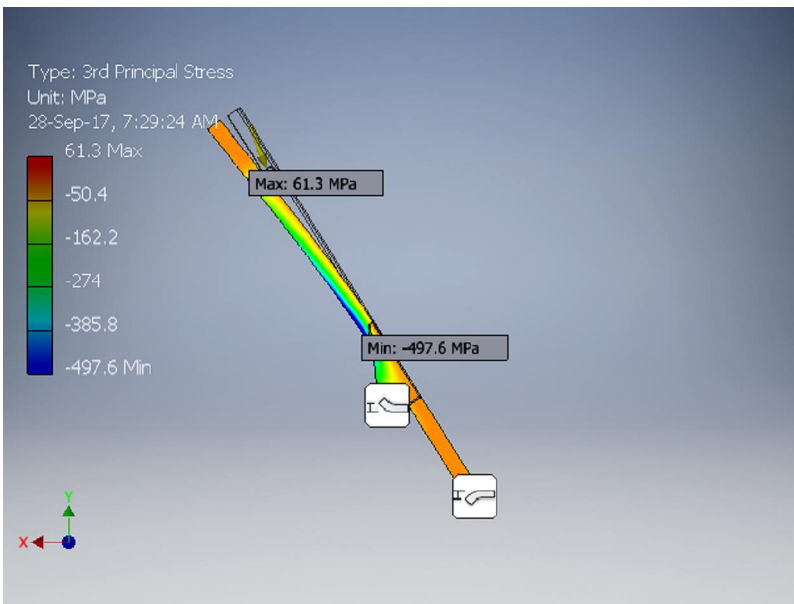

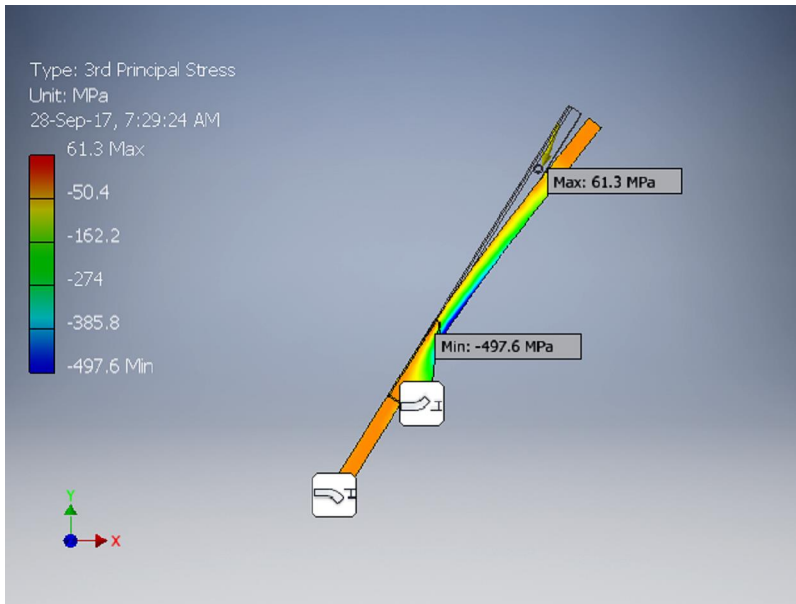

Displacement

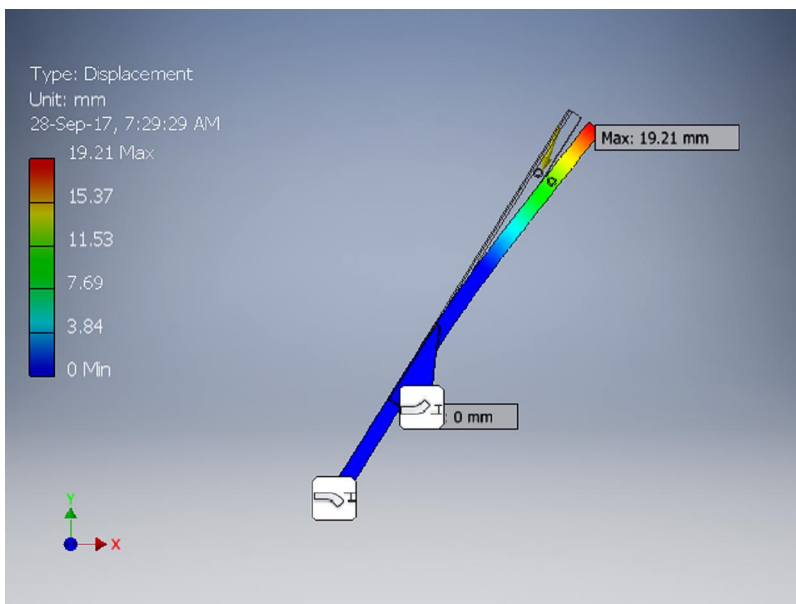
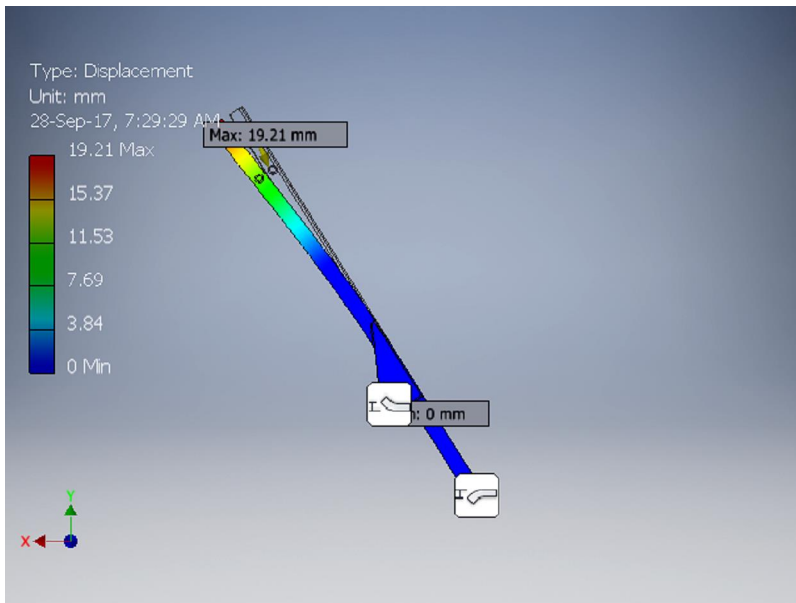

Safety Factor

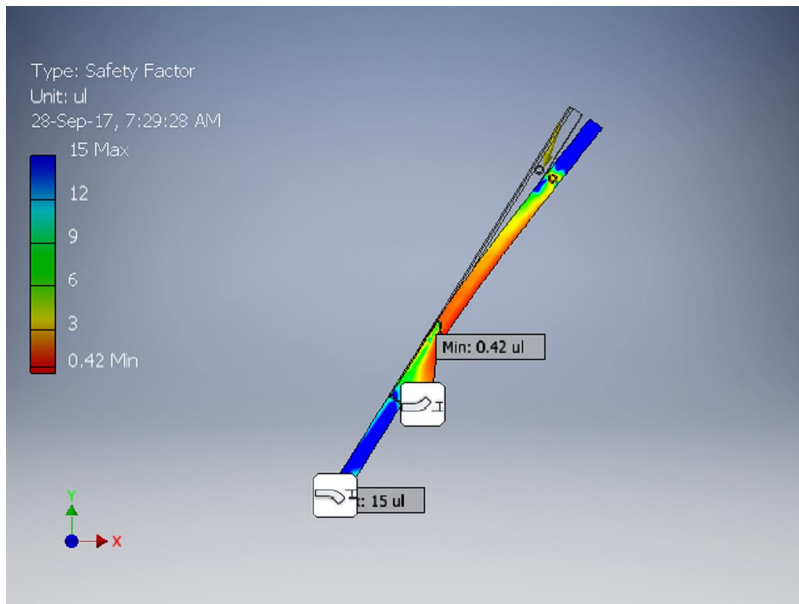
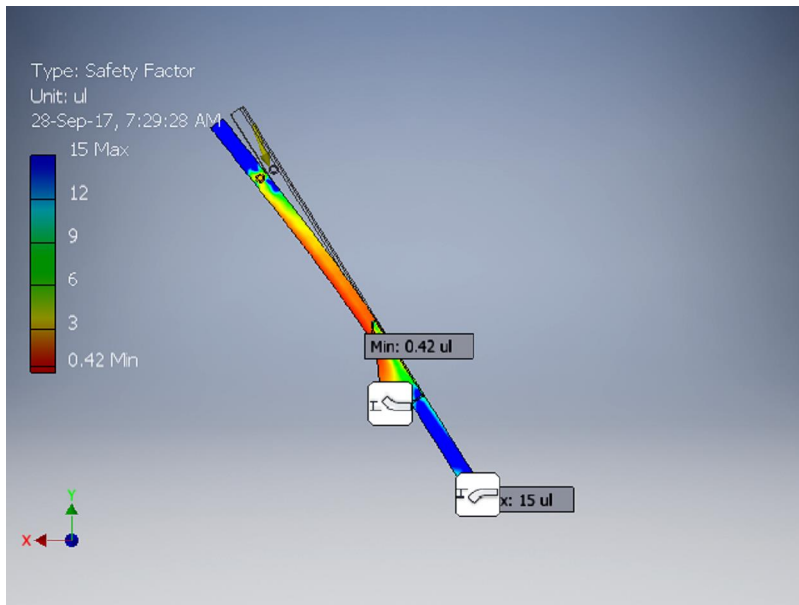

Stress XX

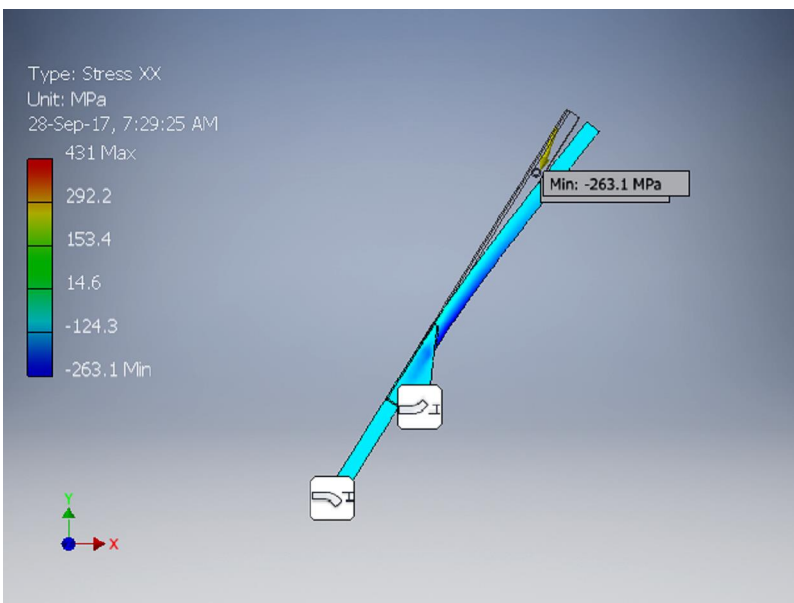
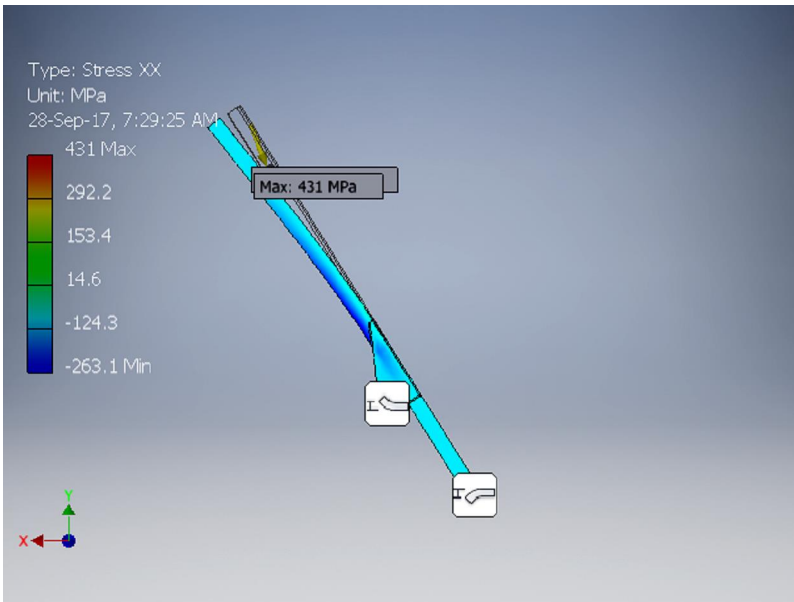

Stress XY

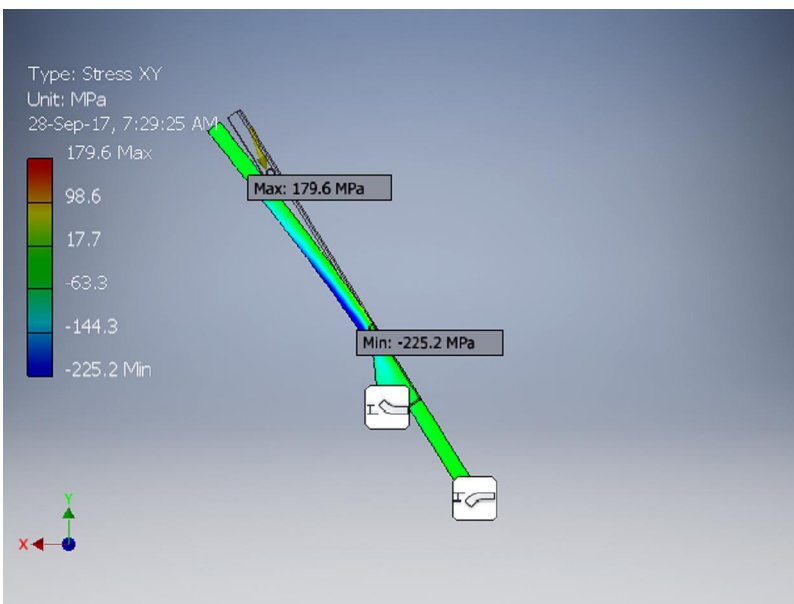

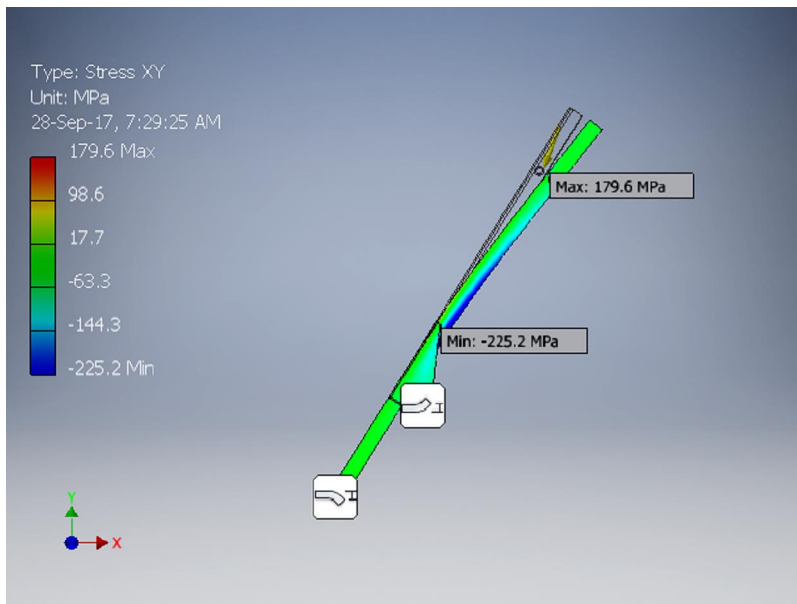

Stress XZ

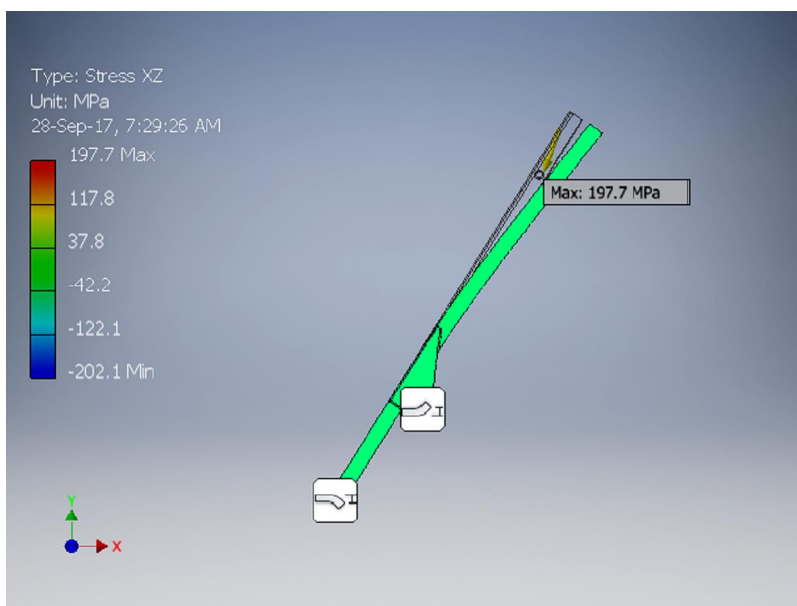
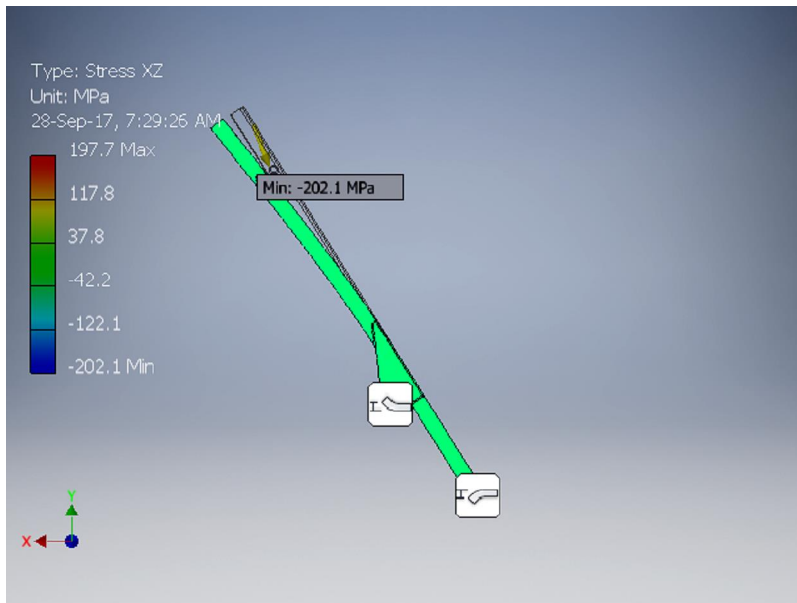

Stress YY

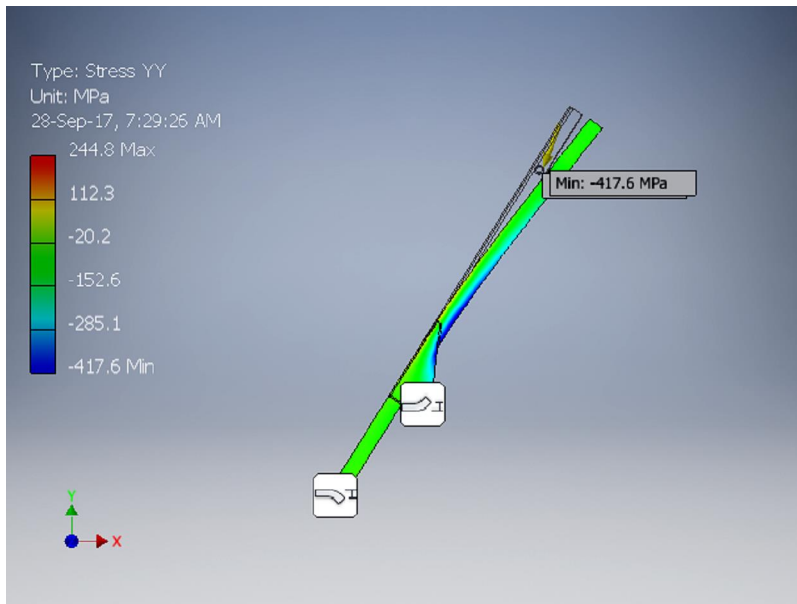
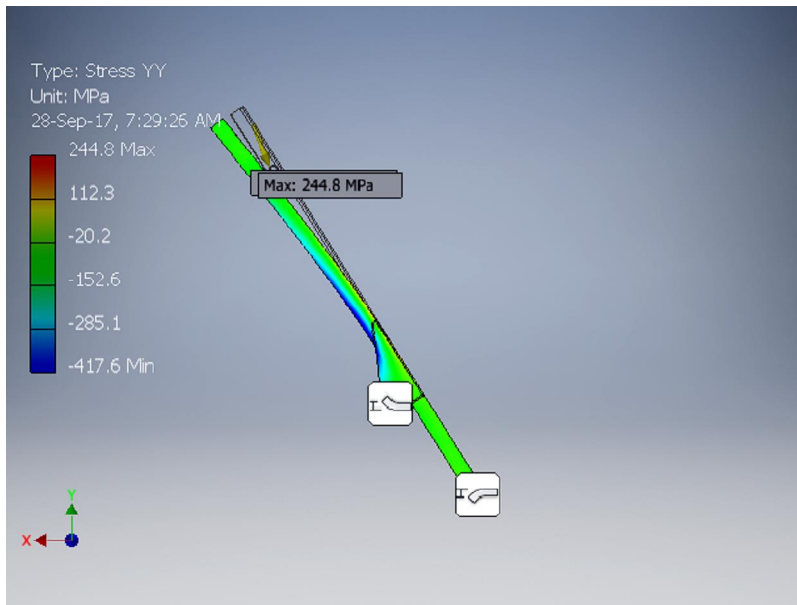

Stress YZ

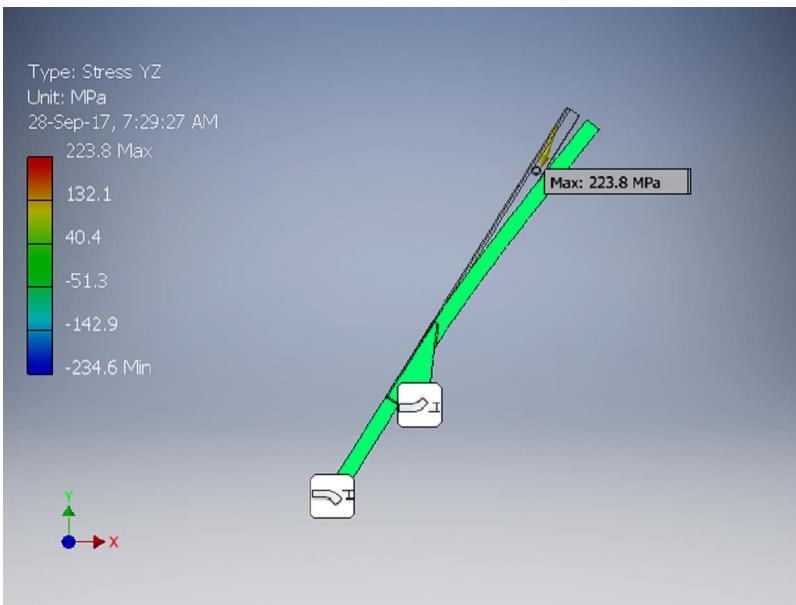
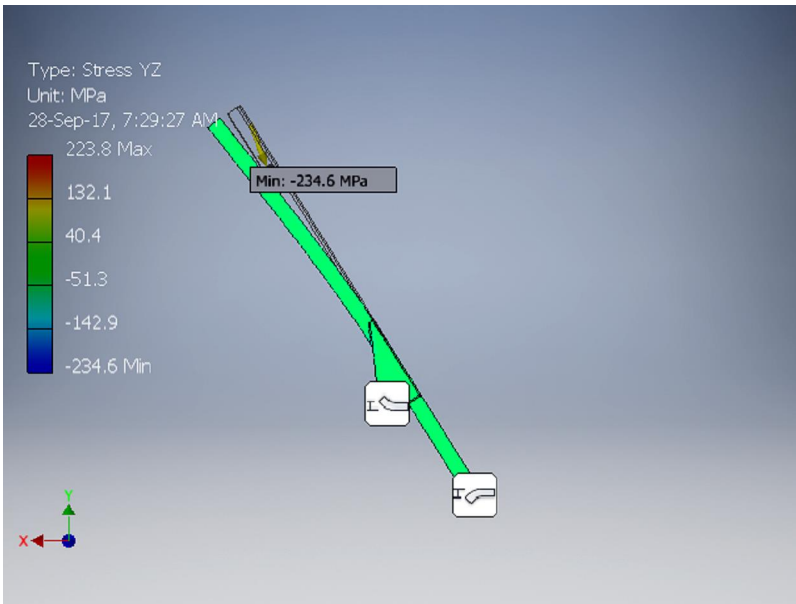

Stress ZZ

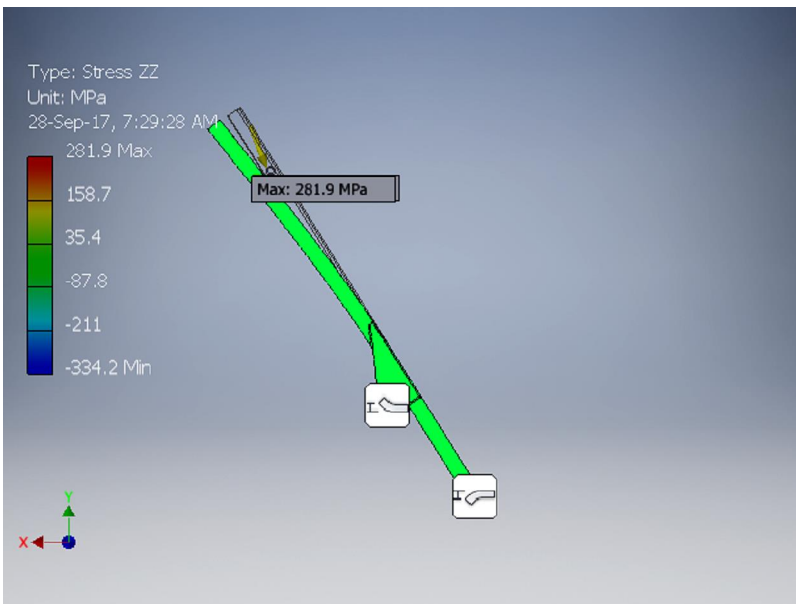

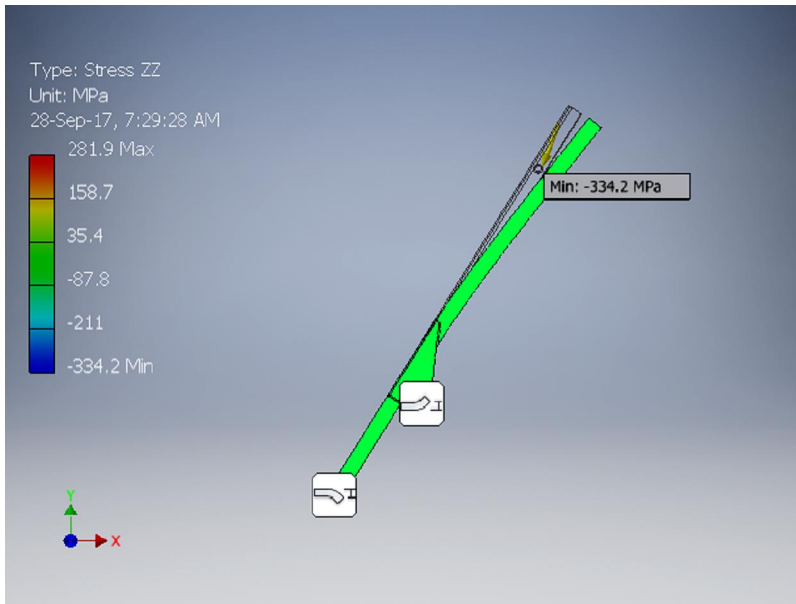

X Displacement

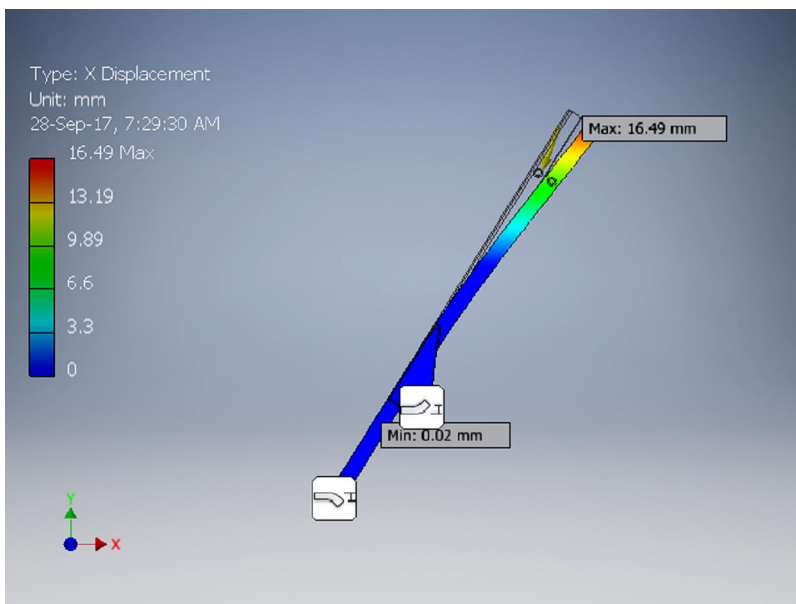
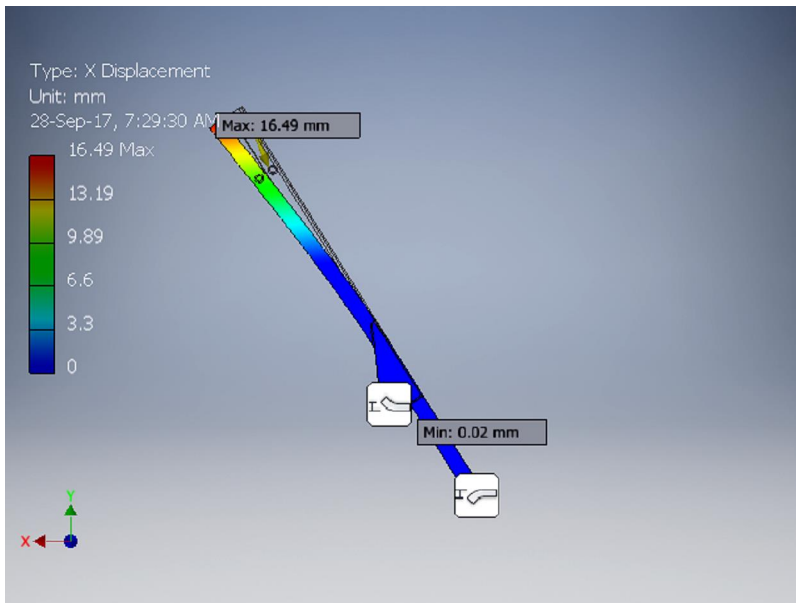

Y Displacement

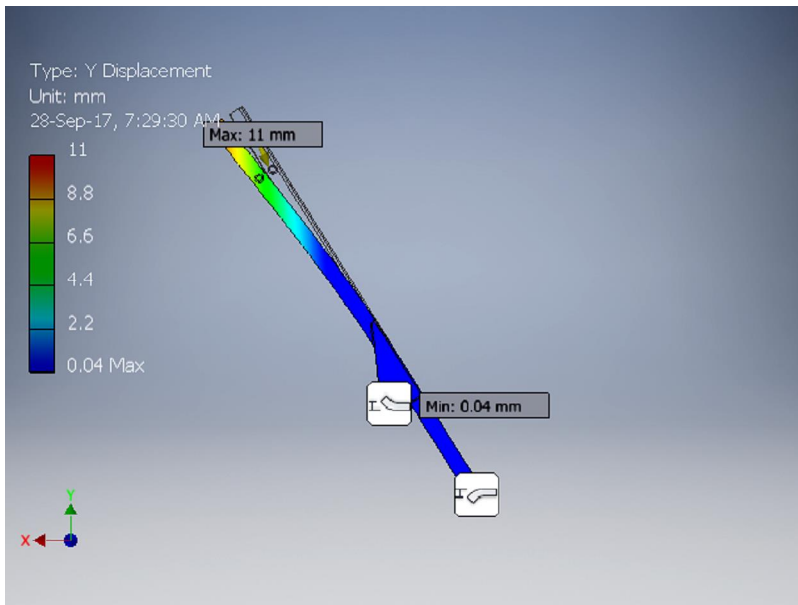

Z Displacement

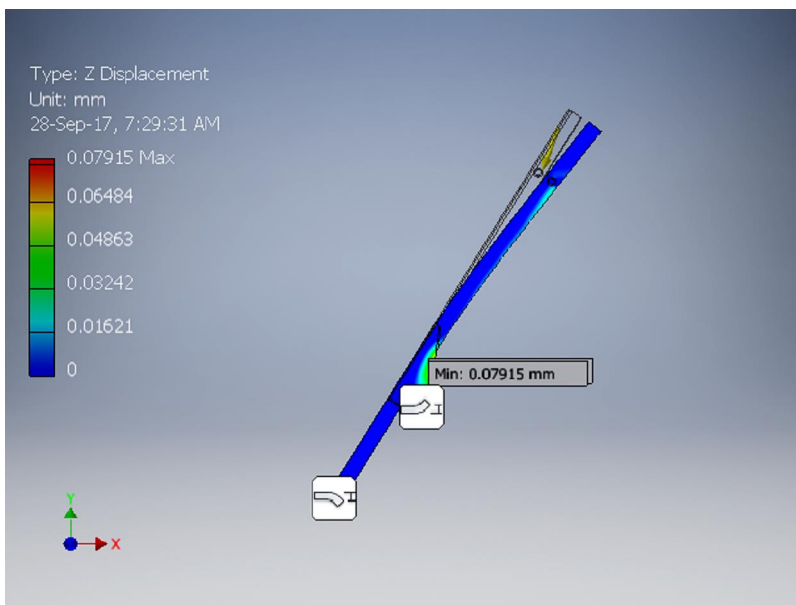
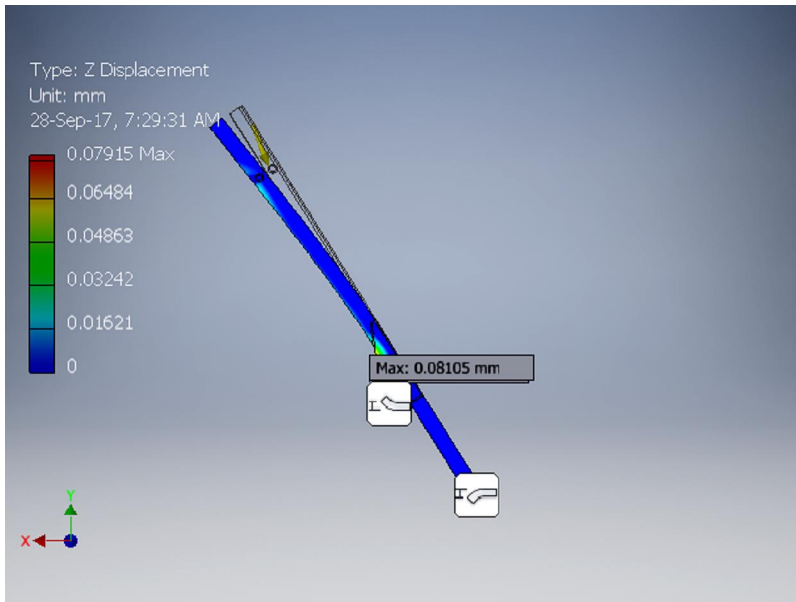

Equivalent Strain

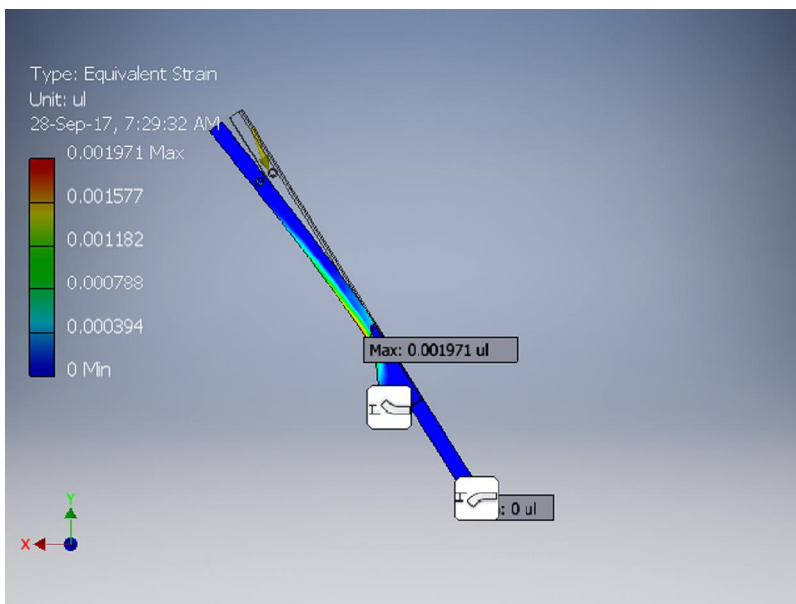

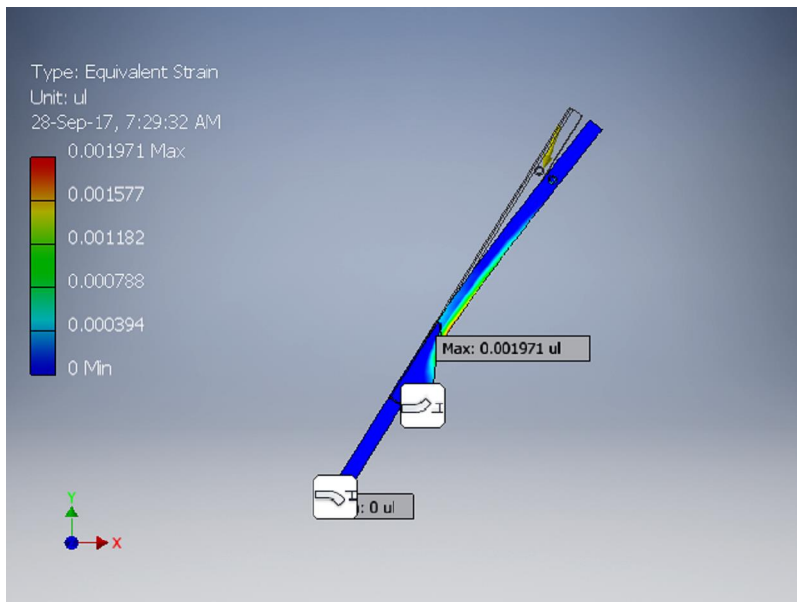

1st Principal Strain

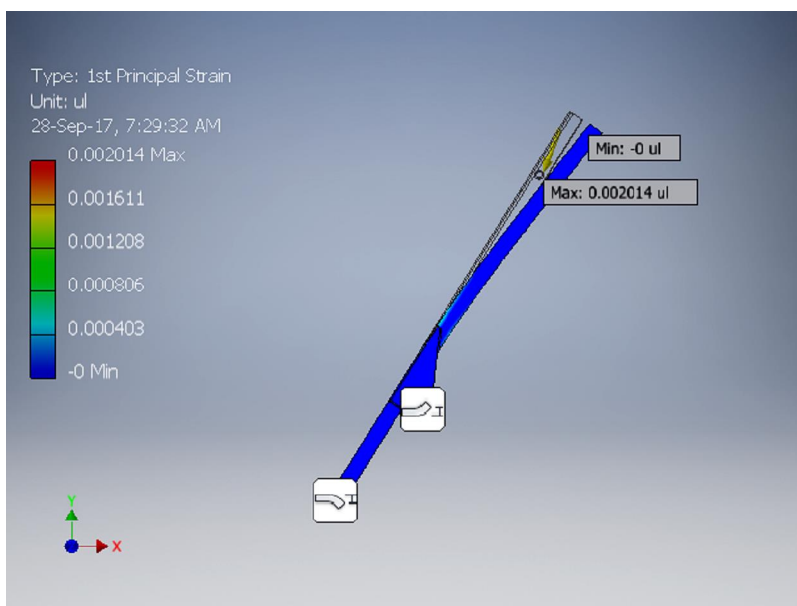
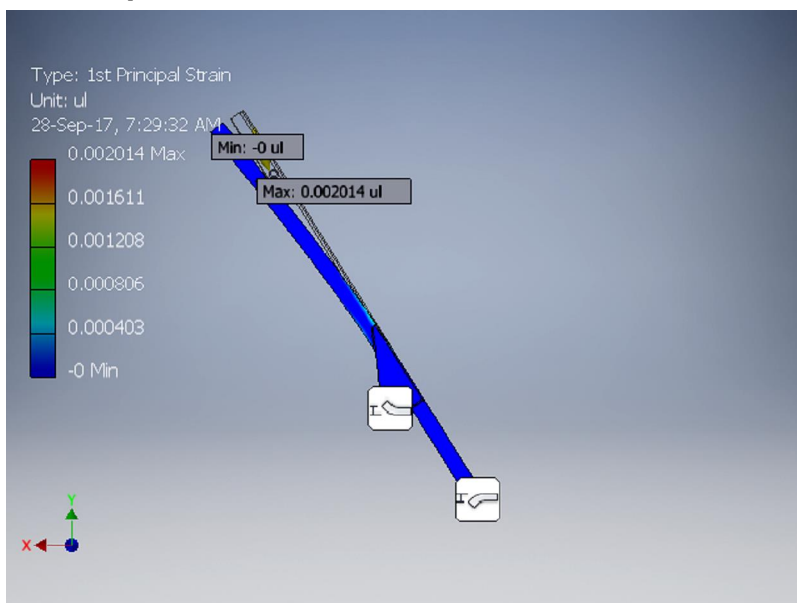

3rd Principal Strain

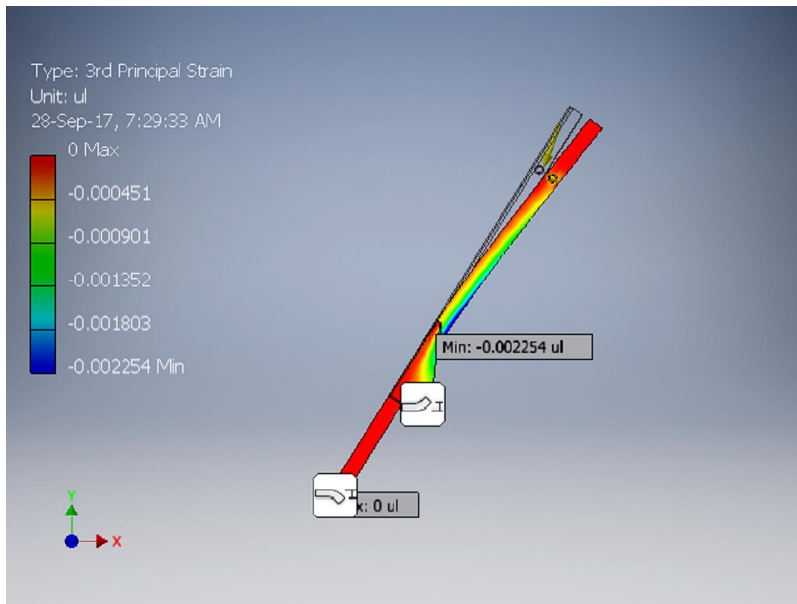
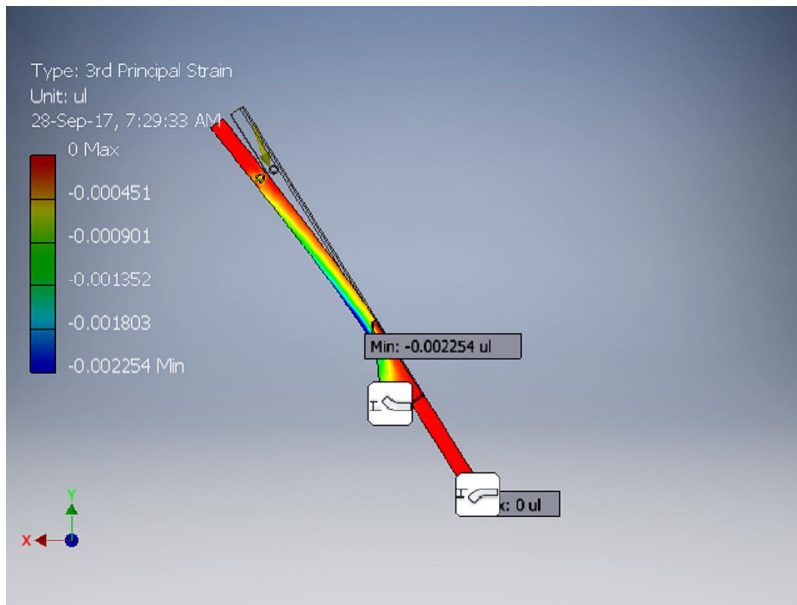

Strain XX

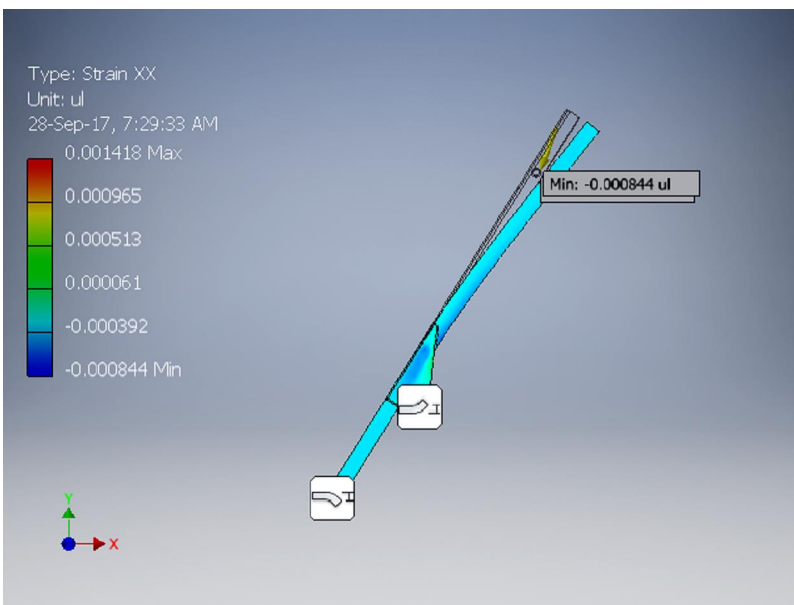
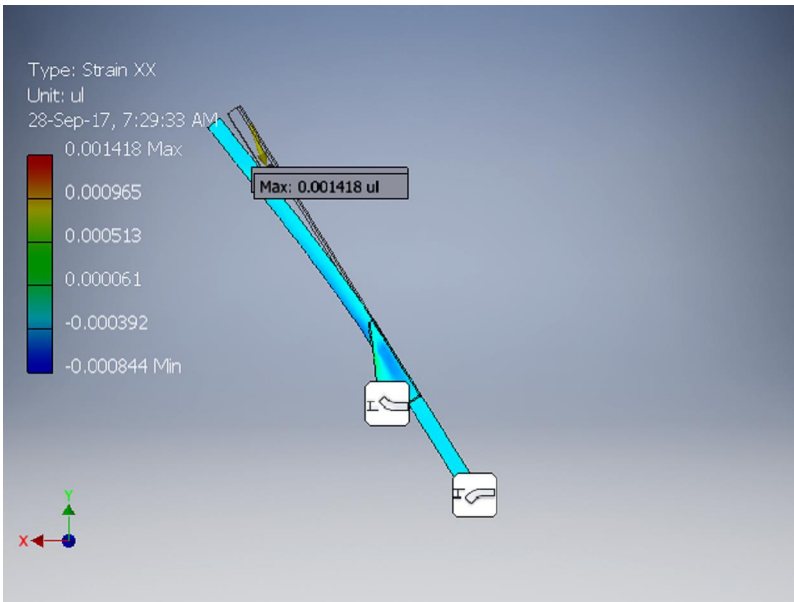

Strain XY

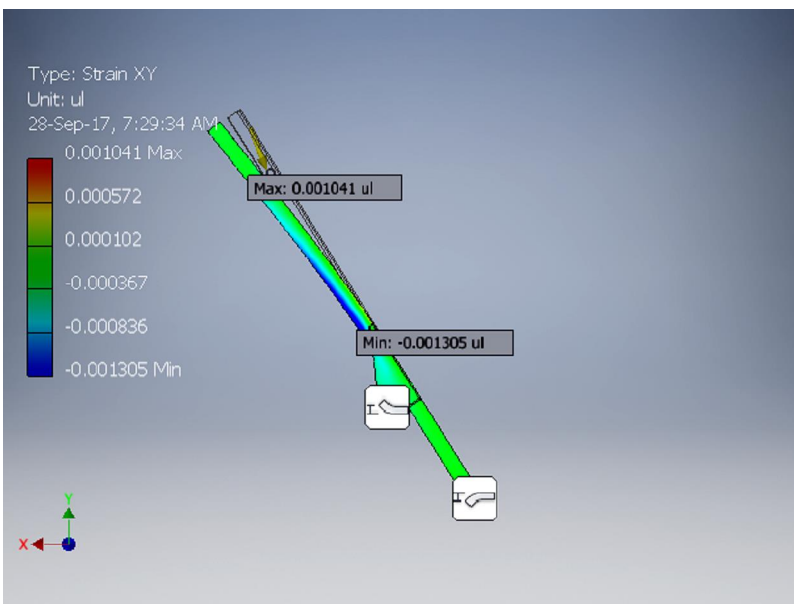

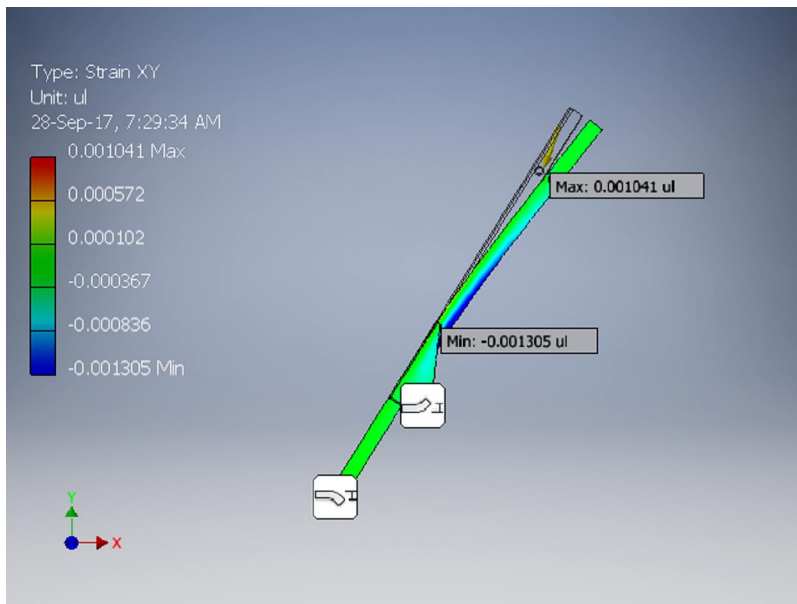

Strain XZ

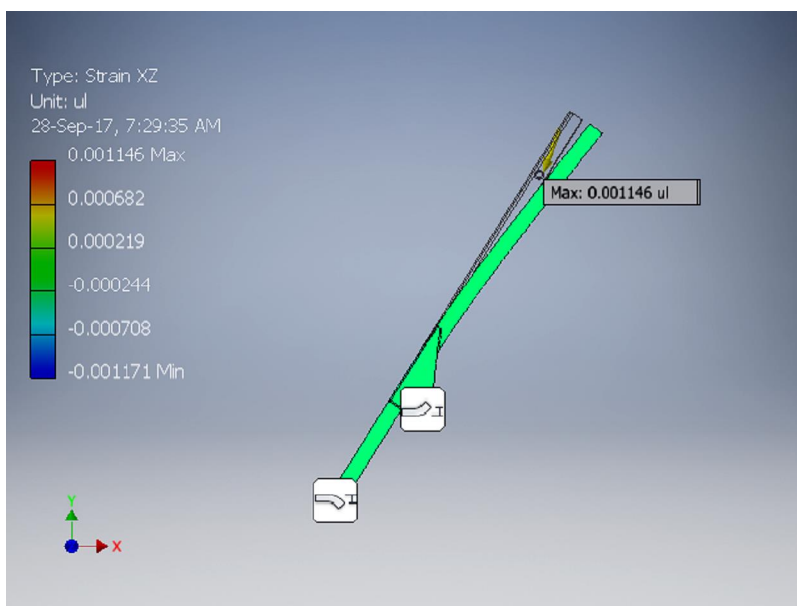
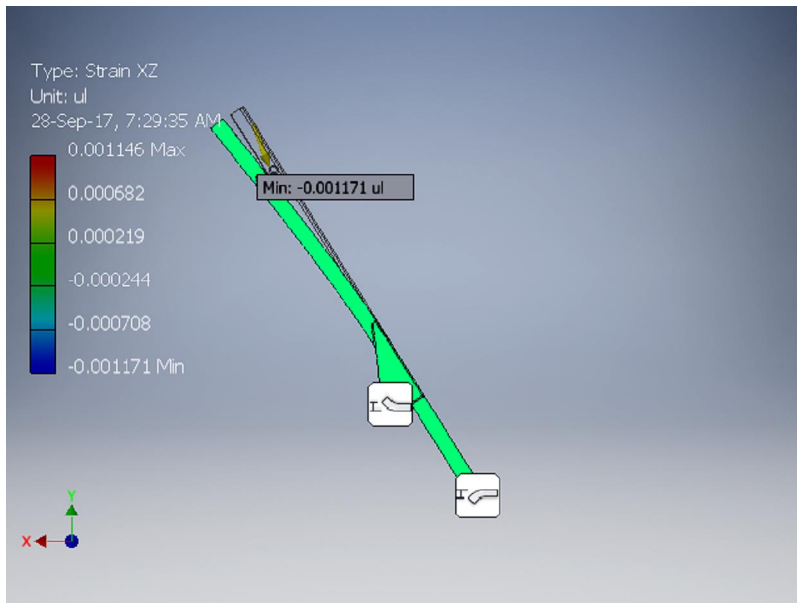

Strain YY

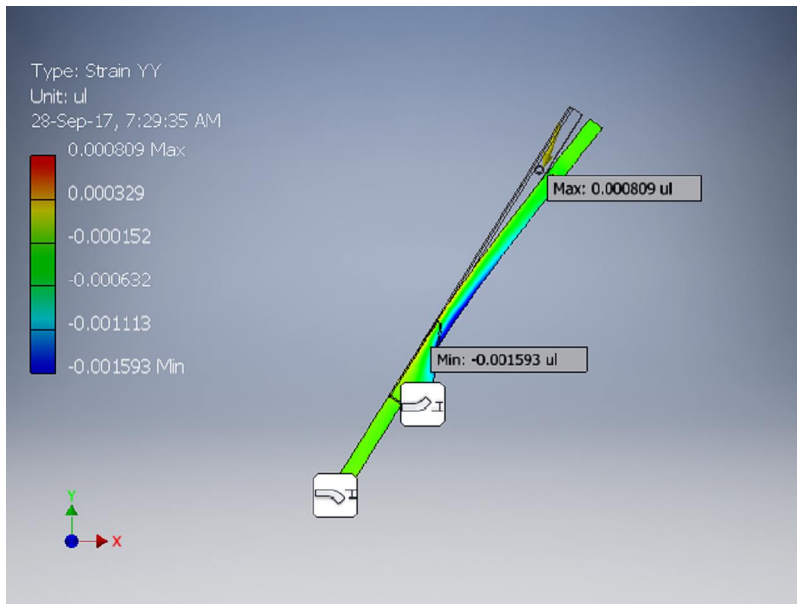
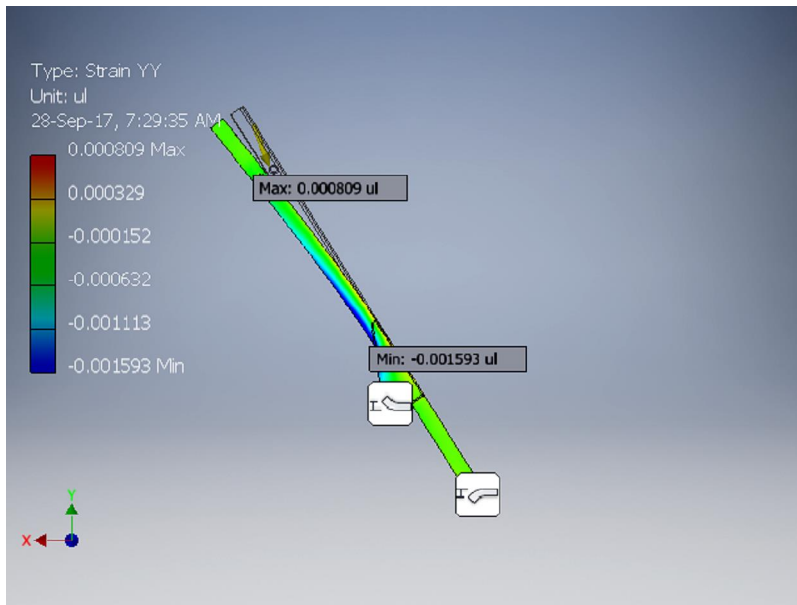

Strain YZ

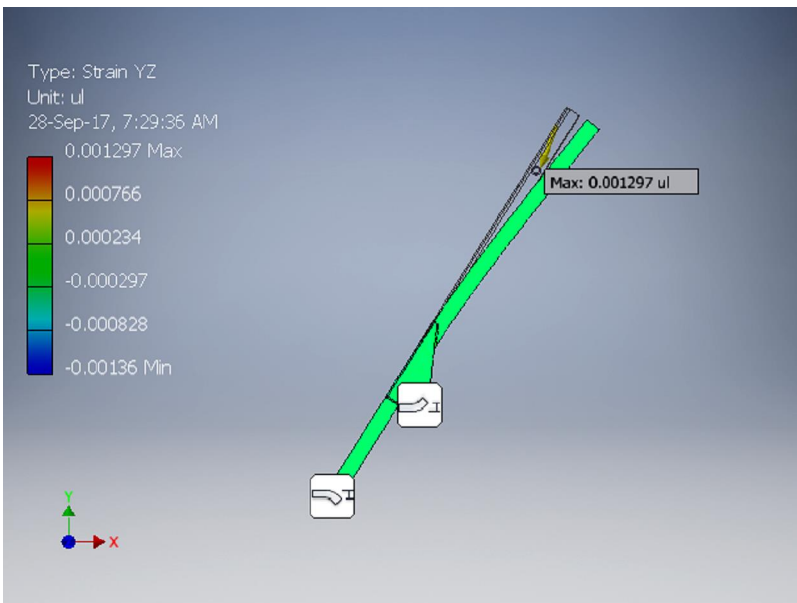
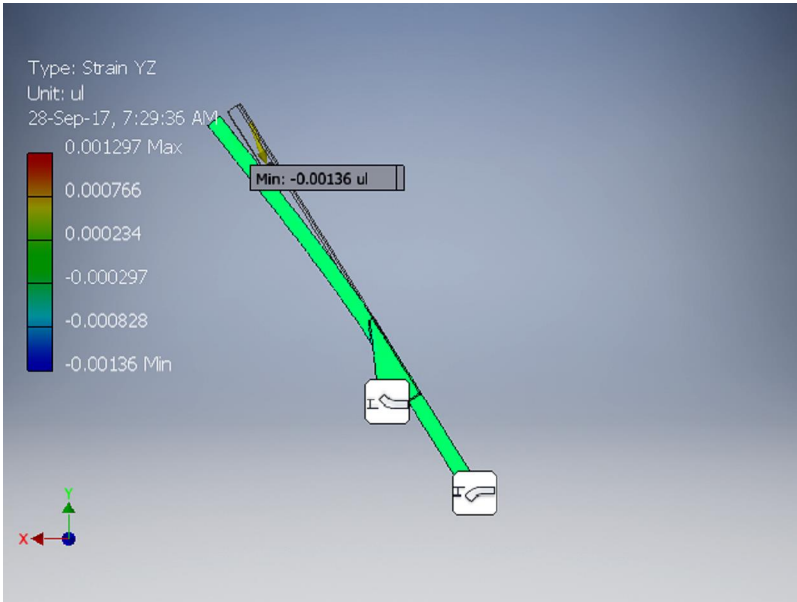

Strain ZZ

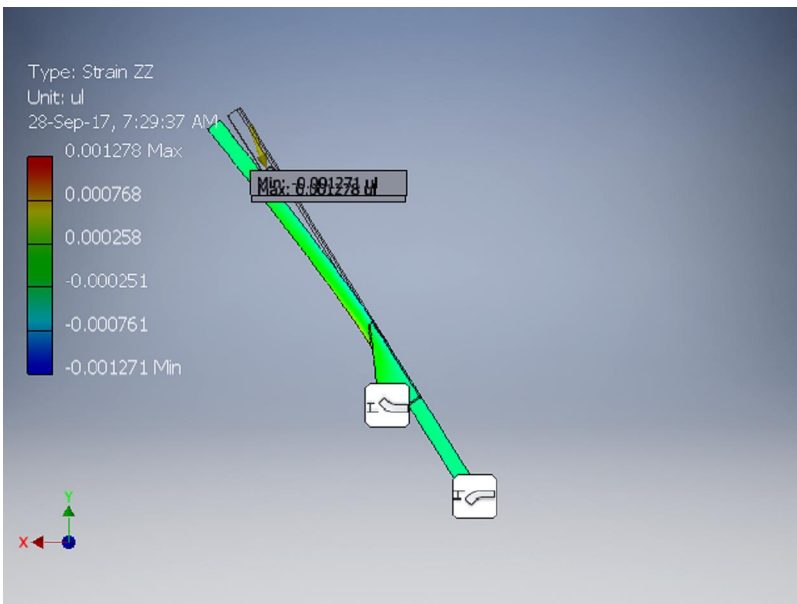

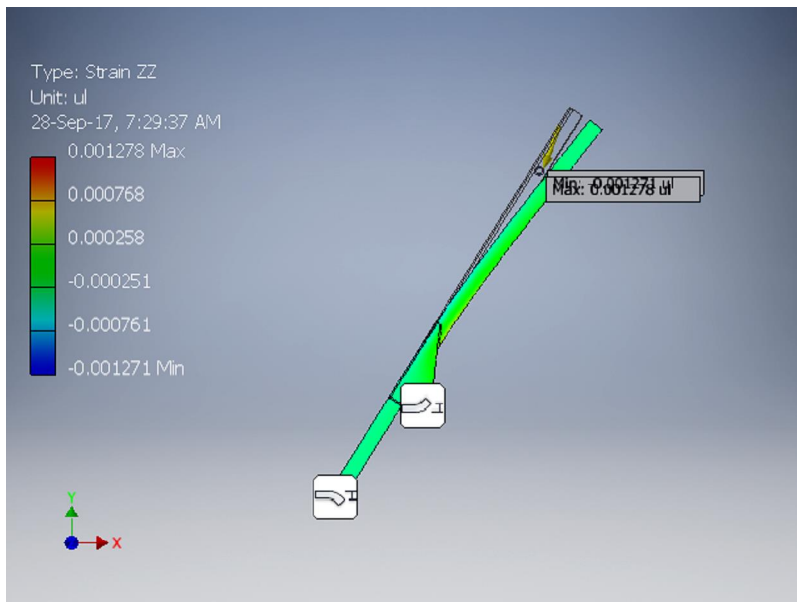

Contact Pressure

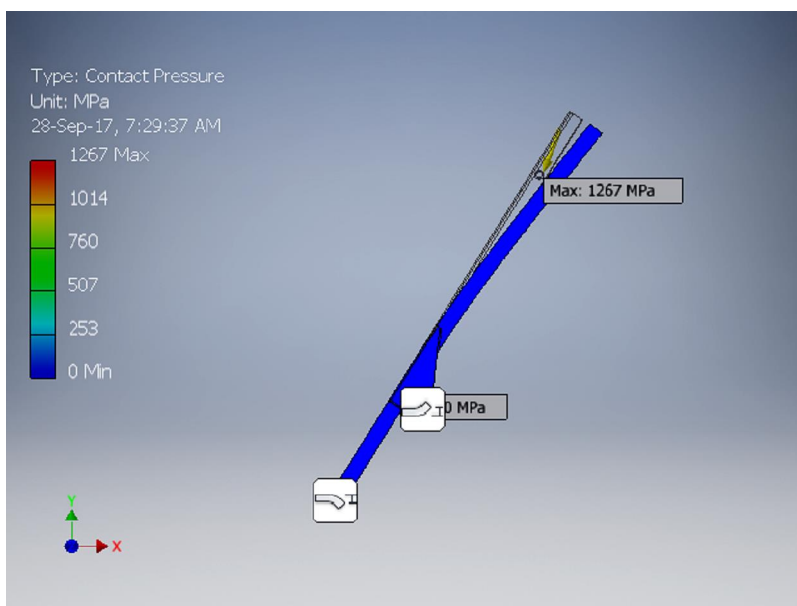
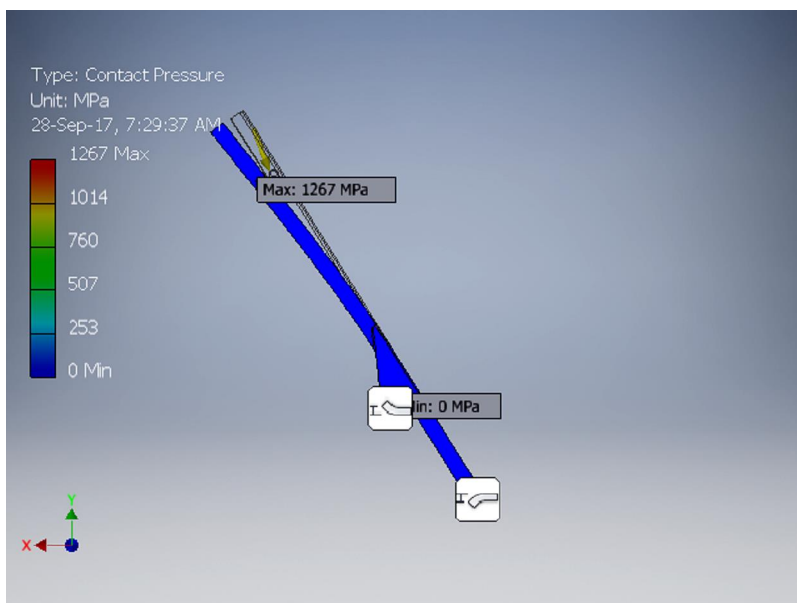

Contact Pressure X

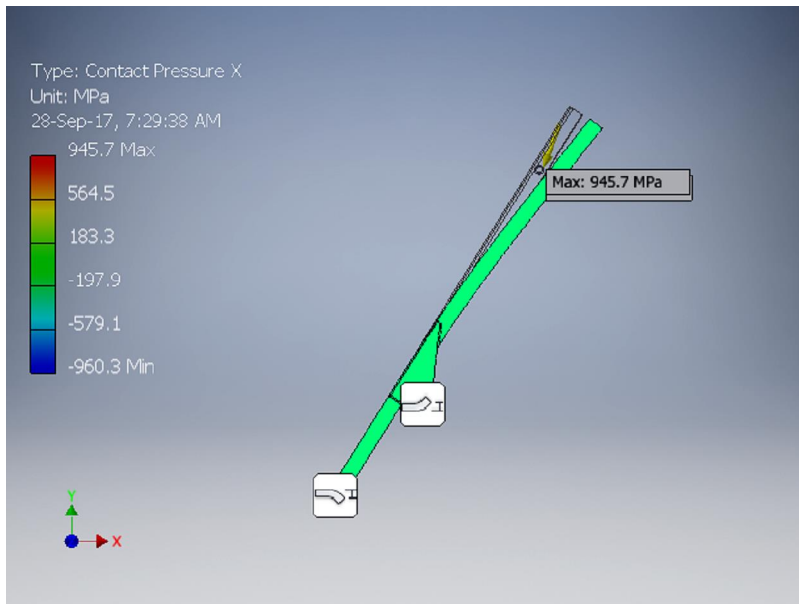
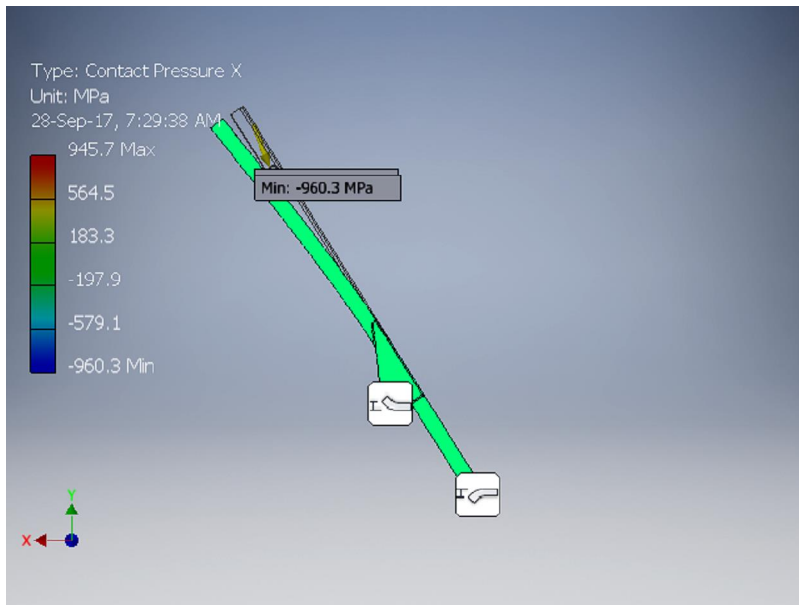

Contact Pressure Y

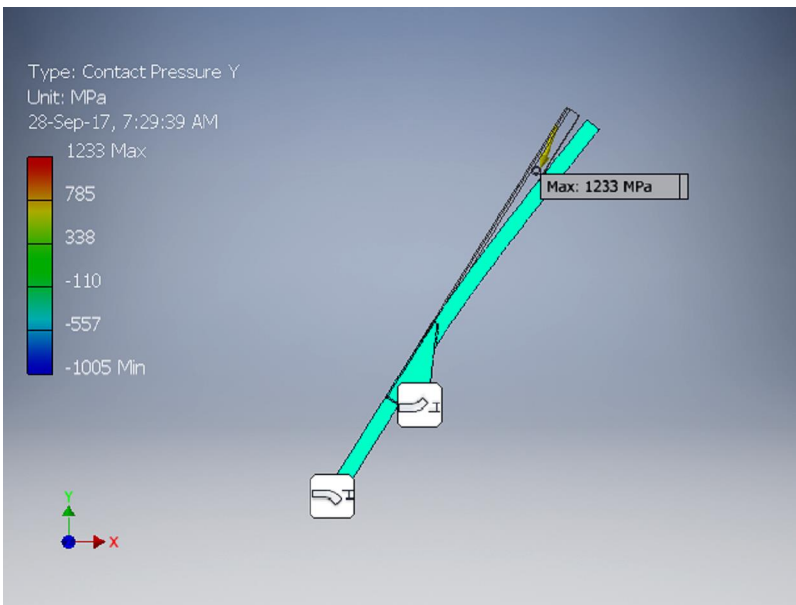
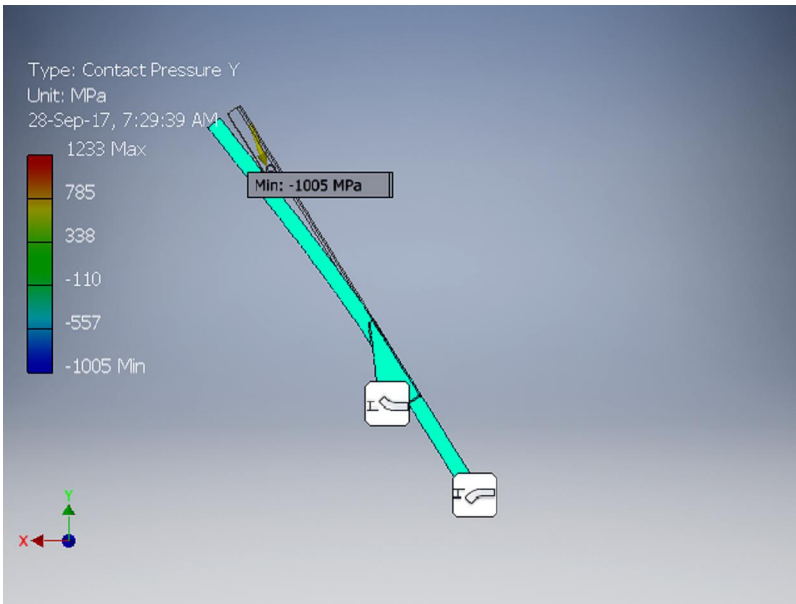

Contact Pressure Z

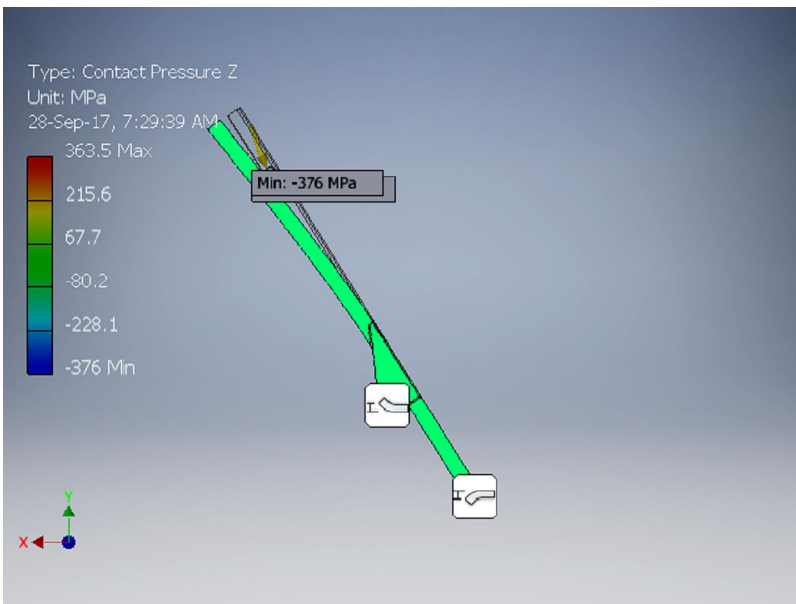

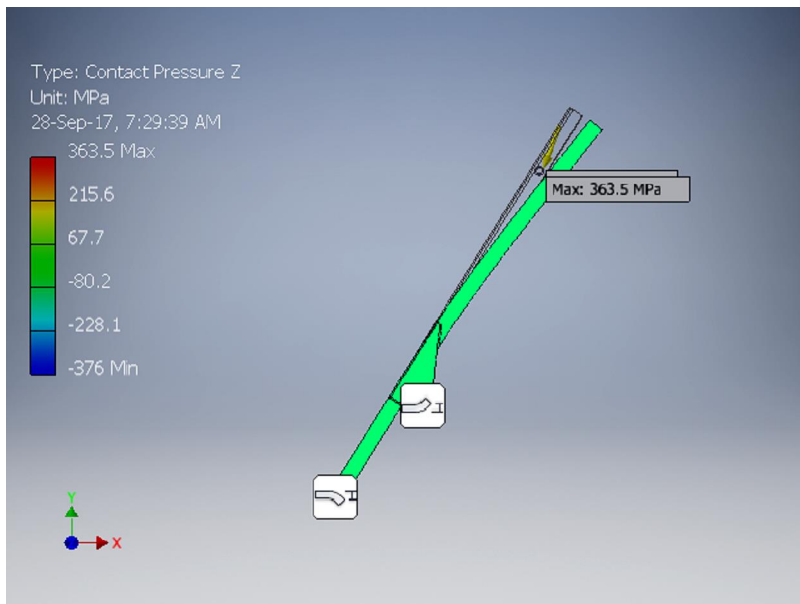

C:\Users\Siva Sooriyan\Desktop\27-09-17\Assembly1.iam