



American Concrete Institute®  
Advancing concrete knowledge

ACI RAP Bulletin 4

FIELD GUIDE TO  
CONCRETE REPAIR  
APPLICATION PROCEDURES

# Surface Repair Using Form-and-Pour Techniques





# Field Guide to Concrete Repair Application Procedures

## Surface Repair Using Form-and-Pour Techniques

Reported by ACI Committee E706

Brian F. Keane  
Chair

J. Christopher Ball  
Floyd E. Dimmick, Sr.  
Peter H. Emmons\*  
Timothy R. W. Gillespie

H. Peter Golter  
Bob Joyce  
Kenneth M. Lozen

John S. Lund  
Richard Montani  
Jay H. Paul

George I. Taylor  
Patrick M. Watson  
David W. Whitmore

\*Primary author.

It is the responsibility of the user of this document to establish health and safety practices appropriate to the specific circumstances involved with its use. ACI does not make any representations with regard to health and safety issues and the use of this document. The user must determine the applicability of all regulatory limitations before applying the document and must comply with all applicable laws and regulations, including but not limited to, United States Occupational Safety and Health Administration (OSHA) health and safety standards.

### Structural Disclaimer

This document is intended as a voluntary field guide for the Owner, design professional, and concrete repair contractor. It is not intended to relieve the user of this guide of responsibility for a proper condition assessment and structural evaluation of existing conditions, and for the specification of concrete repair methods, materials, or practices by an experienced engineer/designer.

ACI Repair Application Procedure 4.

Copyright © 2003, American Concrete Institute.

All rights reserved including rights of reproduction and use in any form or by any means, including the making of copies by any photo process, or by electronic or mechanical device, printed, written, or oral, or recording for sound or visual reproduction or for use in any knowledge retrieval system or device, unless permission in writing is obtained from the copyright proprietors. Printed in the United States of America.

The Institute is not responsible for the statements or opinions in its publications. Institute publications are not able nor intended to supplant individual training, responsibility or judgment of the user, or the supplier of the information provided.

## Introduction

The form-and-pour placement technique is a multistep process of preparation, formwork construction, and placement of repair materials. Repair materials are placed in the cavity between the formwork and the prepared substrate with buckets, pumps, chutes, or buggies. The form-and-pour technique allows the use of many different castable repair materials. Placeability is the primary consideration material selection. Depending on the consistency of the repair material, consolidation is accomplished by vibration, rodding, or when the material has extremely high slump (self-consolidating), no additional steps may be required.

### What is the purpose of this repair?

The primary purpose of this type of repair is to restore the structural integrity, or concrete cover requirements, or both, for the damaged element.

### When do I use this technique?

This technique is commonly used on vertical surfaces such as walls, columns, and other combinations such as beam sides and bottoms. When used to repair slab soffits, the repair material is typically placed through holes or openings cut through the slab. Adhesive bonding agents or grouts are not commonly used with this technique. A trial installation is highly recommended for each project, to verify the preparation, material, and placement technique using quality-control procedures outlined at the end of this document.

The form-and-pour technique offers many advantages:

- Many different types of repair materials can be used;
- Repair material can be placed around reinforcing steel; and
- Formwork protects against early-age drying that promotes cracking.

The primary limitation of the form-and-pour technique is that formwork installation makes it more labor-intensive than alternative placement methods such as shotcrete or hand application (see Fig. 1).

### How do I prepare the surface? (Fig. 2)

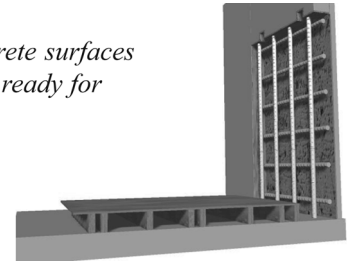
Regardless of the repair method, surface preparation is essentially the same. Concrete is removed until sound concrete is located. Exposed bars are undercut, and surfaces are cleaned with high-pressure water, or are abrasively blasted. With form-and-pour techniques, it is important to understand how the existing surfaces will permit the repair material to penetrate and flow. On partial-depth vertical repairs, the upper edges of vertical surfaces should be trimmed to eliminate potential pockets of entrapped air and promote complete filling from the location of the chute. Refer to page 5 for step-by-step preparation procedures.

*Step 1*—Sound the concrete to locate areas of delamination.

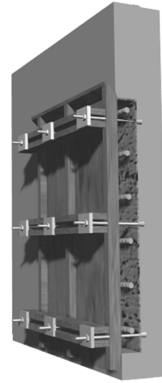
*Step 2*—Remove unsound concrete with a 15-lb chipping hammer. Hammers larger than a 15-lb class may cause damage to the substrate and reinforcement.

*Step 3*—Mark the perimeter of the repair area. Layout should be simple square or rectangular shapes.

*Prepared concrete surfaces with formwork ready for erection.*

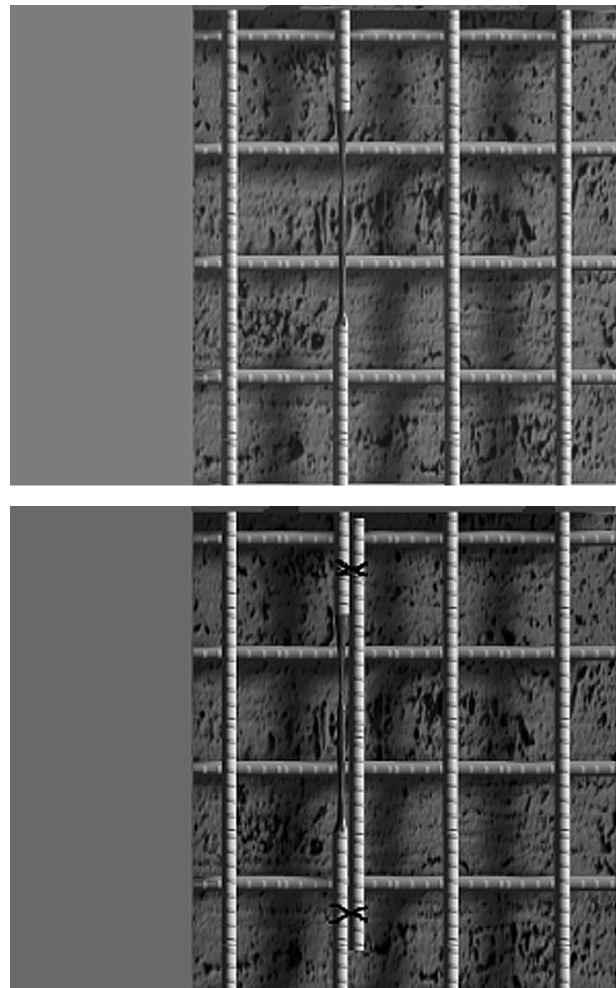


*Fig. 1(a).*



*Fig. 1(b).*

*Section view through repair showing formwork and chute at top for placement of repair material.*



*Fig. 2—Lapping of supplemental reinforcement.*

*Step 4*—Sawcut the perimeter of the repair. Note: sawcut should not be deeper than the cover over reinforcement.

*Step 5*—Repair reinforcement as necessary. When reinforcing steel is heavily corroded and the diameter is reduced, consult a structural engineer for repair procedures. For many applications, supplemental reinforcement can be lapped to adjacent damaged bars, as shown (see Fig. 2).

*Step 6*—Clean reinforcing steel and concrete with abrasive blasting.

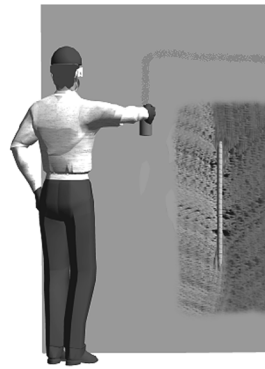
### How do I select the proper repair material?

Constructibility requirements for repair materials used with the form-and-pour technique are limited only by their ability to be transported to the formwork cavity. Maximum aggregate size should not exceed 25% of the space between the formwork and the substrate, or 50% of the distance between the reinforcing steel and the substrate—whichever is smaller. In general, the largest practical maximum size aggregate should be used to minimize drying-shrinkage and reduce the potential for cracking of the repair. Mixtures with high flowability (high slump) will make the placement easier; however, do not sacrifice a low water-cement ratio (<0.40) for high slump. Use high-range water-reducing admixtures as necessary. Prepackaged repair materials, which are designed for high-flow placement, include shrinkage-compensating additives, and are appropriate for many applications. All mixture proportions should be optimized to minimize drying shrinkage. Shrinkage testing in accordance with ASTM C 157 measured over a 120-day period is recommended.

### What equipment do I need?

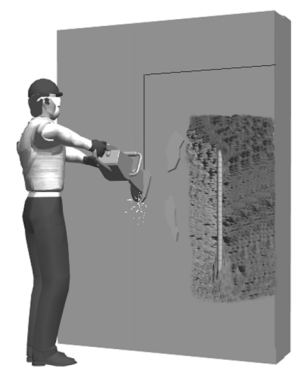
Placement equipment may include either concrete buggies, buckets, or concrete pumps. Concrete pumps should be sized for the type of repair material being placed. If the repair is mixed on site, a portable mixer is required. Check with the manufacturer of the product to determine the recommended type of mixer.

### STEP 3



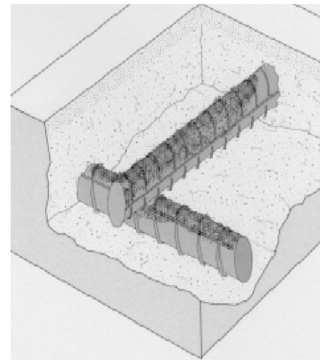
*Mark perimeter of repair area. Layout should be simple geometric shapes.*

### STEP 4



*Sawcutting perimeter of repair. Note: sawcut should not be deeper than cover over reinforcement. Remove sound concrete within sawcut area.*

**STEP 5:** *Reinforcement repair. When reinforcing steel is heavily corroded and the diameter is reduced, consult a structural engineer for repair procedures. For many applications supplemental reinforcement can be lapped to adjacent damaged bars, as shown.*



**Important Note:** *If corroded reinforcing bars are encountered in the preparation process, then concrete surrounding the bars must be removed to fully expose the full circumference. Clearance under the bar should not be less than 3/4 in. (19 mm), or 1/4 in. (6 mm) greater than the largest aggregate size of the repair mixture, whichever is greater.*

### STEP 1



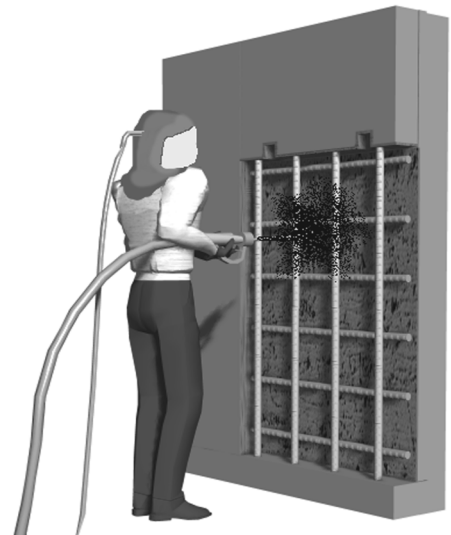
*Sounding of concrete to locate areas of delamination.*

### STEP 2



*Unsound concrete removed with 15-lb chipping hammer. Hammers larger than a 15-lb class may cause damage to substrate and reinforcement.*

### STEP 6



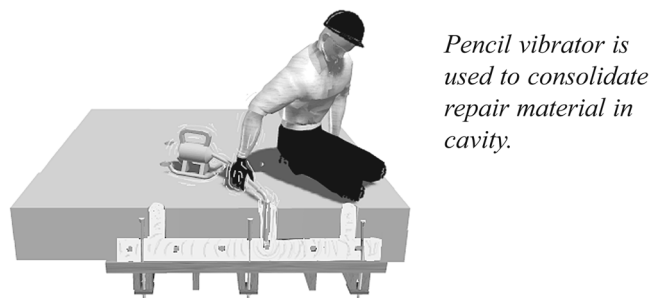
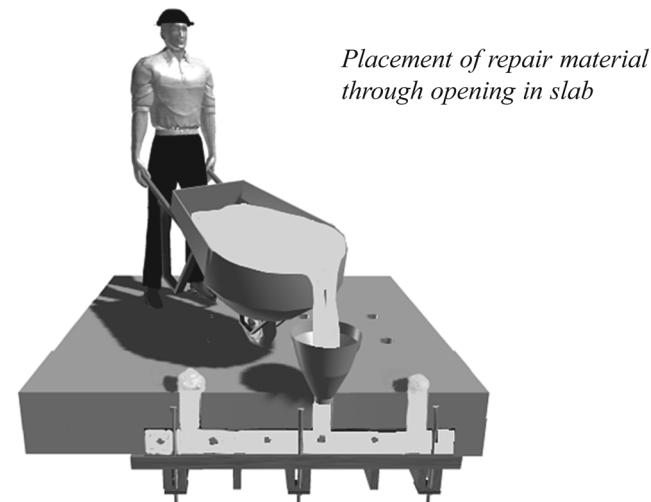
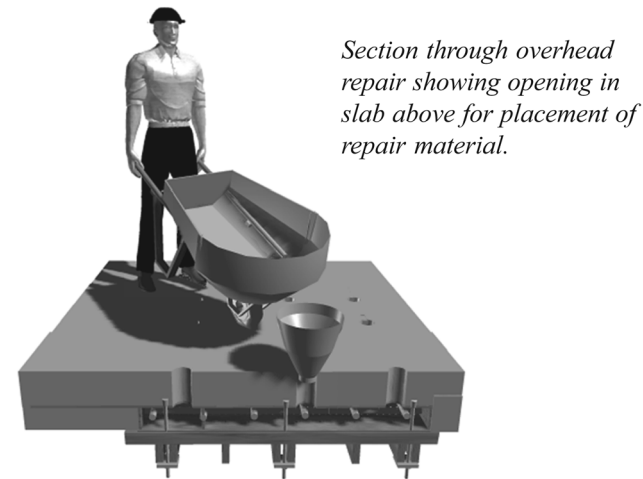
*Cleaning of reinforcing steel and concrete with abrasive blast.*

### What are the safety considerations?

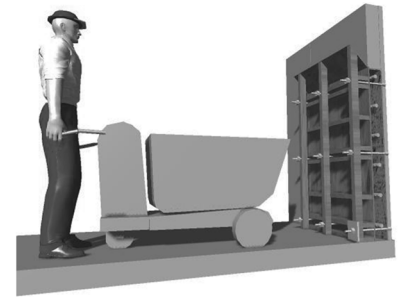
Job site safety practices include, but are not limited to, the following where applicable:

- Material Safety Data Sheets (MSDS) available;
- Protective clothing worn by workers handling or exposed to hazardous materials;
- Use of protective eyewear during pumping and placement of repair materials;
- Availability of eye wash facilities; and
- Use of respirators and ear protection during demolition.

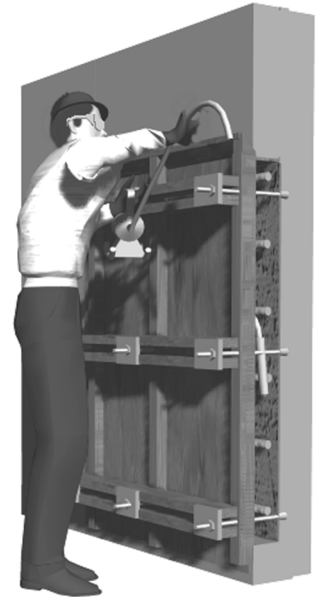
It is the responsibility of the user of this document to establish health and safety practices appropriate to the specific circumstances involved with its use. ACI does not make any representations with regard to health and safety issues and the use of this document. The user must determine the applicability of all regulatory limitations before applying the document and must comply with all applicable laws and regulations, including but not limited to, United States Occupational Safety and Health Administration (OSHA) health and safety standards.



Repair material is brought to the repair site via concrete buggy or other suitable means. Five-gallon buckets make useful tools to deposit repair material into form.



After the repair material is placed into cavity, vibrators are inserted into placement and consolidated. It is recommended that consolidation be done in lifts of no more than 2 to 3 ft (0.7 to 1 m).



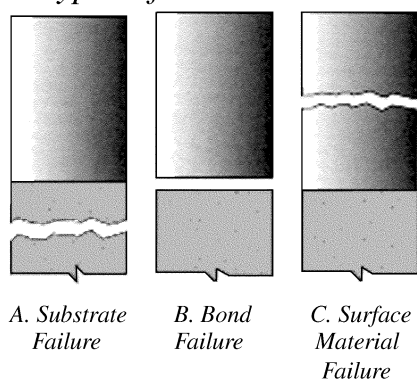
Curing compound is immediately rolled or sprayed onto repaired surfaces after formwork is removed. Proper curing will help ensure repair material does not have premature drying and cracking, and the material develops its full strength.



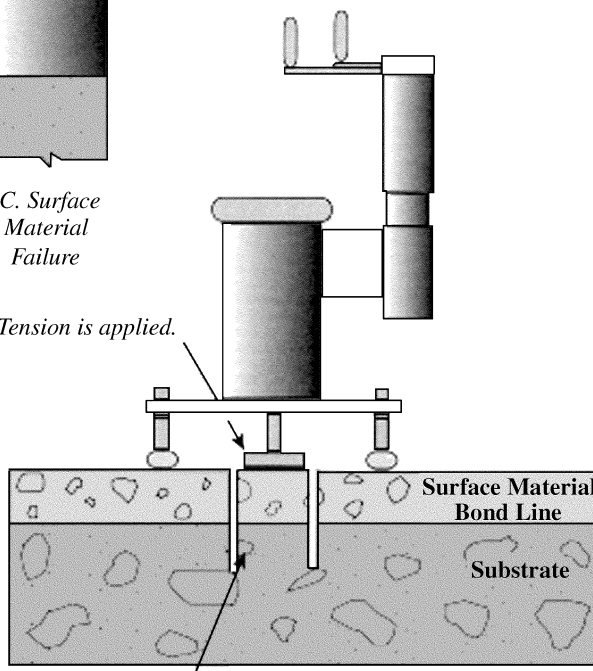
Fig. 3—Material placement: horizontal application.

Fig. 4—Material placement: vertical application.

## Types of Tensile Breaks



Device is glued to surface. Tension is applied.



Cored hole through surface material and into substrate

Fig. 5—Test procedure.

### Preconstruction meeting

Prior to proceeding with the repair, a preconstruction meeting is recommended. The meeting should include representatives from all participating parties (owner, engineer, contractor, materials manufacturer, etc.), and specifically address the parameters, means, methods, and materials necessary to achieve the repair objectives.

### Repair procedure

**Formwork construction**—Formwork must accommodate the mass and pressure of the repair material. Design of the forms should follow standard practice for cast-in-place concrete construction. Formwork is best attached directly to the concrete surface with expansion anchors or rock anchors designed for coil rod. In cases of repair of slab soffits (underside), scaffold frames or shoring posts can be used to support the formwork tight against the concrete surfaces. When expansion/rock anchors are used, ensure anchors are firmly set in place to prevent slippage under load. Preloading of rock anchors with coil rod can be accomplished with a center-hole jack applying loads to the coil rod with a stand-off. Forms should be constructed to fit tightly against existing surfaces. Preformed gaskets or cast-in-place foam work well on difficult-to-match surfaces. Placement openings or chutes are required to place the repair material behind vertical forms. Chutes should be constructed to permit development of a hydraulic head above the prepared upper edges of the concrete surface. This will provide for repair material supply into these upper horizontal zones after concrete is

consolidated. For large, vertical surfaces exceeding 10 ft (3 m) in height, multiple lifts should be considered to reduce free-fall segregation and excessive formwork pressures. Formwork for overhead surfaces does not require openings for placement of repair materials. Generally, placement occurs through openings in the slab from above.

**Material placement**—Prior to placement of the repair material, moisture conditioning of the prepared surface should provide for saturated-surface dry conditions. It is important not to overwet the surface. Saturated surfaces will prevent proper bonding because the surface pores are clogged with water, unable to absorb the repair material. Mixed repair material is brought to the formed area via whatever transport technique is appropriate for the situation. This may include buckets, pumpline, buggies, or wheelbarrows. For vertical surfaces, material is placed into the chute or opening. External or internal vibration is a must for almost all mixture consistencies. Some self-leveling repair materials, also known as self-consolidating, can be placed without vibration. When the cavity is filled, extra care should be taken to ensure that the uppermost surfaces are filled adjacent to the chute or opening where placement occurs. Rodding or tamping can ensure proper filling. Formwork should be left in place for the prescribed curing period. After stripping of formwork, any spaces not filled should be trimmed, cleaned, and dry-packed. Placement of a membrane curing compound is recommended immediately after removal of formwork.

### How do I check the repairs?

After stripping of forms, various tests can be performed to confirm that the repair material was thoroughly consolidated and that adequate bond to the substrate was achieved. A uniaxial bond test can be performed by drilling through the repair into the substrate. A bonded plate attached to the core is pulled until rupture occurs. The location of the failure should be reviewed. Bond values typically exceed 100 psi (0.7 MPa) and, in most cases, exceed 150 psi (1 MPa). These tests are performed in accordance with ACI 503R Appendix (see Fig. 5).

The complete repair area should also be hammer-sounded to locate voids and delaminations within the top 6 in. (150 mm). Any hollow sounds may indicate poor bond or voids.

### Sources for additional information

1. "Guide for Surface Preparation for the Repair of Deteriorated Concrete Resulting from Reinforcing Steel Corrosion," No. 03730, International Concrete Repair Institute, 1995, 5 pp.
2. "Guide for Selecting and Specifying Concrete Repair Materials," No. 03733, International Concrete Repair Institute, 1996, 34 pp.
3. ACI Committee 347, "Guide to Formwork for Concrete (ACI 347-01)," American Concrete Institute, Farmington Hills, Mich., 2001, 32 pp.
4. ACI Committee 546, "Concrete Repair Guide (ACI 546R-96)," American Concrete Institute, Farmington Hills, Mich., 1996, 41 pp.
5. ACI Committee 503, "Use of Epoxy Compounds with Concrete (503R-93)," American Concrete Institute, Farmington Hills, Mich., 1998, 28 pp.