

IF IN DOUBT ASK		
ISS	ALTERATION	ISSUED BY & DATE
A	*	*
B		
C		
1		
2		01 FEB 08
3		28 FEB 08
4	RUMBLE ADDED	01 MAY 08
5	00034	21 MAR 11
6	00046	SMCC 08 NOV 2012
7		

REF NO	PART NUMBER	DESCRIPTION	QTY	REMARKS

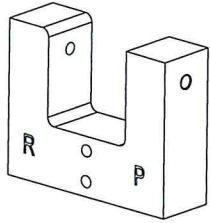

SCRAP ISOMETRIC VIEW

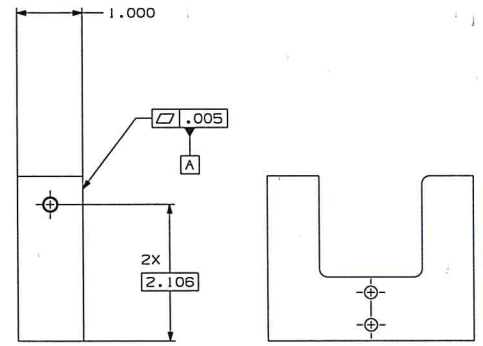
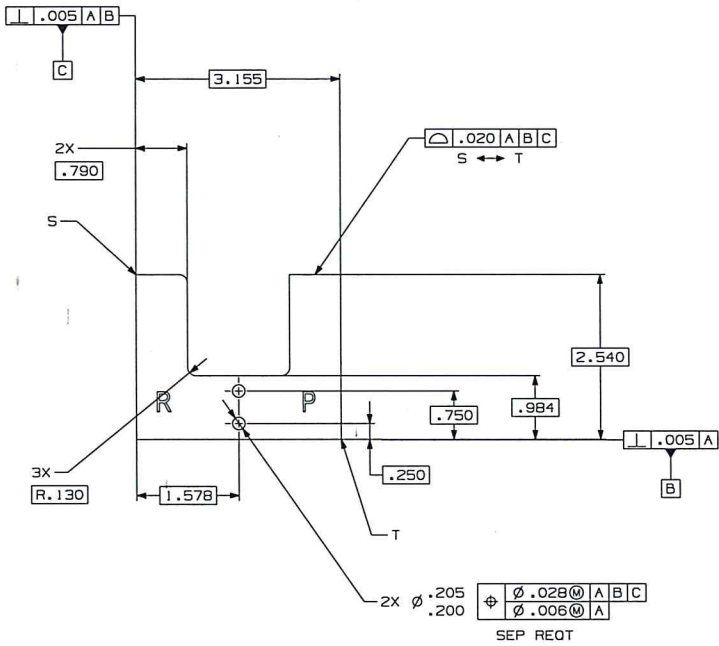
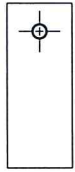

2X M12 X 1.5-6H  
 L .720 ± 0.500  
 Φ .028 @ A|B|C  
 SEP REQT

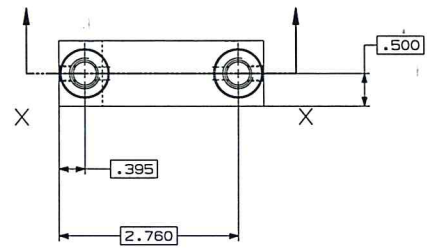

AUXILLARY VIEW SHOWING LOCATION OF LASER ENGRAVING  
 LASER ENGRAVE 'R' & 'P' IN POSITIONS SHOWN (THIS FACE ONLY)

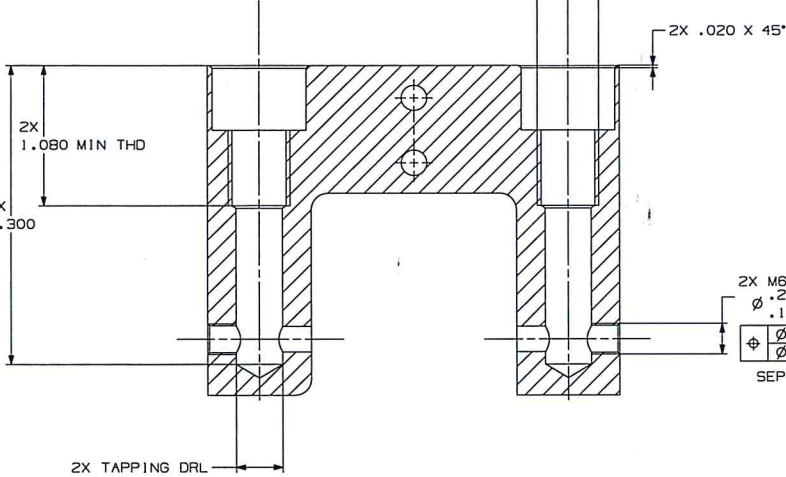
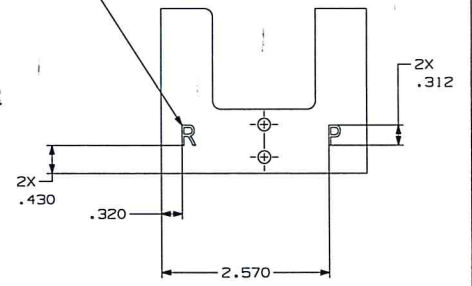

2X M6 X 1-6H ±0.312  
 Φ .201 THRU .197  
 Φ .014 @ A|B|C  
 Φ .006 @  
 SEP REQT

- 1.
- 2.
- 3.
- 4.
- 5.

SECTION X-X  
 SCALE 2:1

IT NOT BE ALTERED MANUALLY (ALL DIMS IN INCHES UNLESS OTHERWISE STATED)

DWG SIZE A1 SH

INCHES  
 FRACTIONAL