

GIS Substation Design and Execution

HV and EHV GIS application and design considerations



Jean-Louis Habert
Alstom Grid
GIS product Line

List of contents

Session 1 – April 8th, 2014

- GIS introduction
- Surrounding conditions
- GIS vs. indoor AIS
- Replacing an outdated AIS by a GIS
- Reliability – availability - maintainability

GIS introduction

SF6 properties

1/7
1/3

- A GIS is the implementation, within a complete HV substation, of the remarkable sulphur hexafluoride (SF6) properties in terms of voltage withstand and current interruption
- SF6 main data
 - Neutral gas: insulators and live parts are perfectly protected from contamination and oxidation
 - Density 6.15 kg/m³ at atmospheric pressure
 - To be considered in access rules / low points
 - Reversibility of electric arc dissociation
 - Circuit-breakers chambers most often require no maintenance
 - High liquefaction temp, -25/30°C for 6.3/5.5 bar @ 20°C
 - Liquefaction shall be avoided
 - The lower the pressure, the lower operating temperature and lower ratings

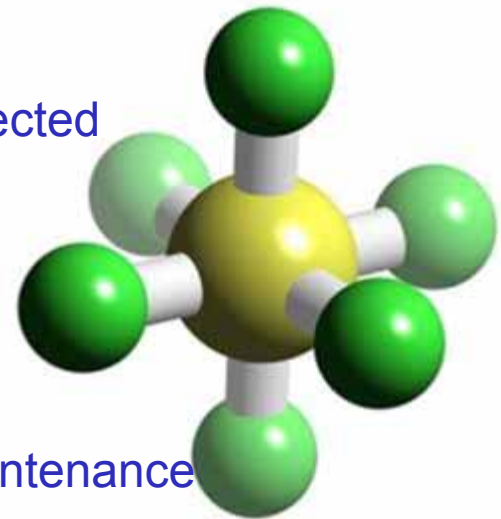

GIS introduction

SF6 properties – Voltage withstand

2/7
2/3

- Dimensional comparison, at 362 kV, of a support insulator on its frame, within an air-insulated substation (AIS) and a GIS element
- GIS technology enables to divide by 10 to 25 the area of a HV switchyard

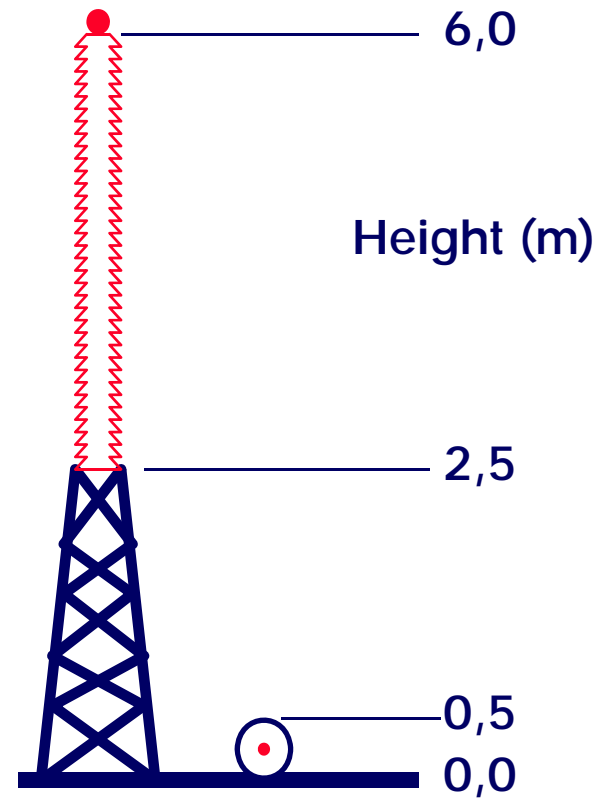

GIS introduction

SF6 properties – voltage withstand

3/7

3/3

- Dimensional comparison, at 362 kV, of an AIS main busbar crossing, and a GIS busbar crossing
- GIS technology enables to divide by minimum 3 the height of a HV switchyard

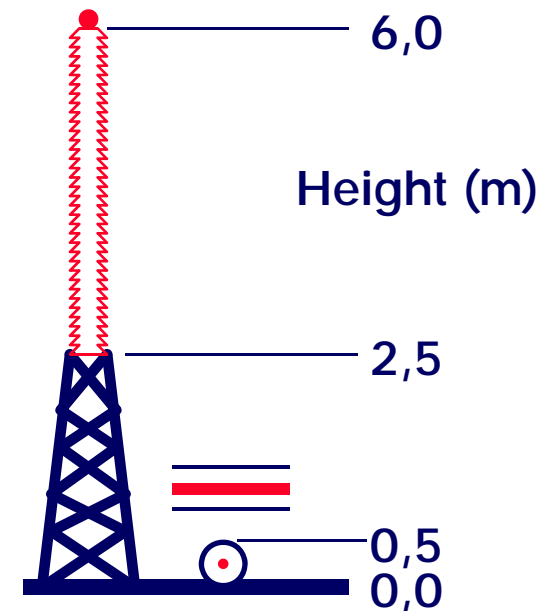

GIS introduction

SF6 properties – current interruption capability

4/7

1/1

- Arc cooling
 - High dissociation energy
- Free electrons capture
 - Fluor ions electronegativity
- Fast recovery of voltage withstand
 - Very fast recombination of dissociated molecules
- Oil to SF6 move, through compressed air, enabled to drastically simplify circuit-breakers
 - At 550 kV, number of breaking chambers has been divided by up to 6, while both short-circuit current and breaking requirements went up



*Canada -
Mica - 550 kV
- old 6-breaks
CB replaced
by 2-breaks
modern CB*



GIS introduction

Applications - Generation

5/7
1/3



Brazil – Tucuruí – 550 kV

GIS introduction

Applications - Transmission

6/7
2/3



*UK –
Norton –
420 kV*

GIS introduction

Applications - Distribution

7/7
3/3



USA - Anaheim – 69 kV



Surrounding conditions Overview

1/14
1/1

- GIS perfectly match all surrounding conditions
 - Air pollution
 - Saline contamination
 - Altitude above sea level
 - Sand winds / storms
 - High humidity in tropical / equatorial countries
 - Earthquake areas
 - Hazardous areas
 - Installation under the ground level
 - Installation in multi-storey buildings
- GIS have minor environmental impact
 - Low visual impact
 - Low electromagnetic disturbances

Surrounding conditions Retrofit / extensions

2/14
1/2



*France - Lille - 245 kV
GIS has more bays than previous AIS*

Surrounding conditions Retrofit / extensions

3/14
2/2



France -
Strasbourg -
72 kV



Surrounding conditions Pollution - urban / industrial



France - Paris -
72 and 245 kV

Surrounding conditions

Saline contamination – sea side / offshore

5/14
1/1



*Spain – Biscaya –
420 kV on sea side*

*UK – Barrow wind
farm – 132 kV
offshore platform*

Surrounding conditions

Hot conditions

6/14
1/1



*Saudi Arabia - Qassim - 420kV
Outdoor temperature up to +55°C*

Surrounding conditions

Cold conditions

7/14
1/1



*Canada – Sainte Marguerite – 330 kV
-50 °C (-58 °F) outdoor temp*

Surrounding conditions

Dry and sandy conditions

8/14
1/1



*Saudi Arabia –
Jubail – 420kV*



Surrounding conditions

Wet conditions

9/14
1/1



- 100 % humidity rate does not impact GIS operation
- Gasket material shall prevent any electrochemical process

Singapore – 72 kV GIS

Thailand – South Thonburi – 245 kV



Surrounding conditions At high altitude above sea level

10/14
1/1

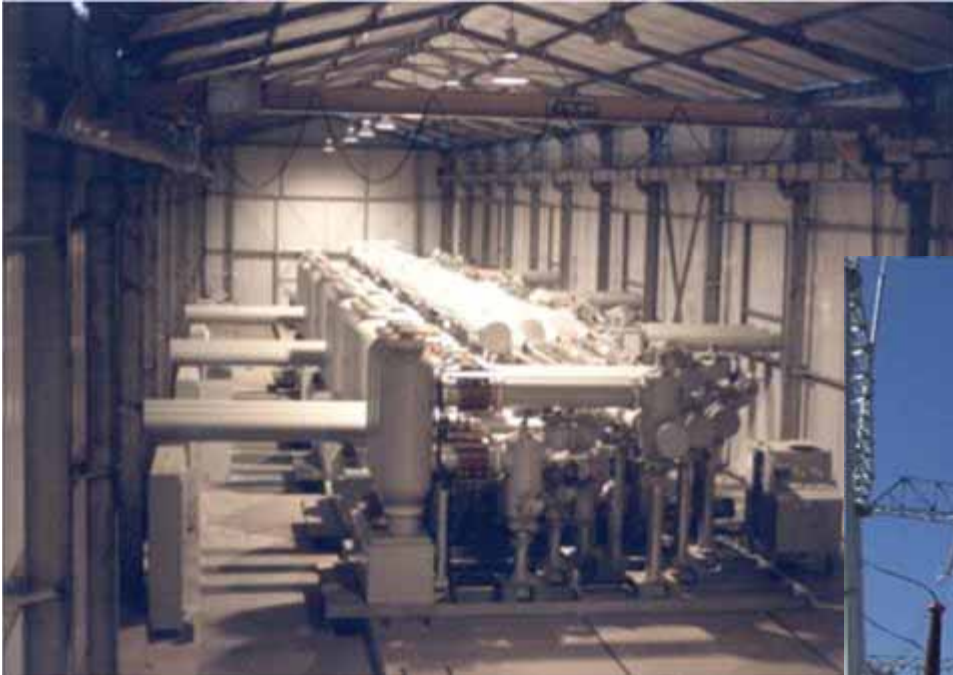

*China – Sergu – 550 kV
4000 m a.s.l.*



*Peru - Pachachaca - 245 kV
4100 m a.s.l.*

- SF6 density is not impacted, thus GIS voltage withstand remains unchanged

Surrounding conditions In severe earthquake areas

11/14
1/1

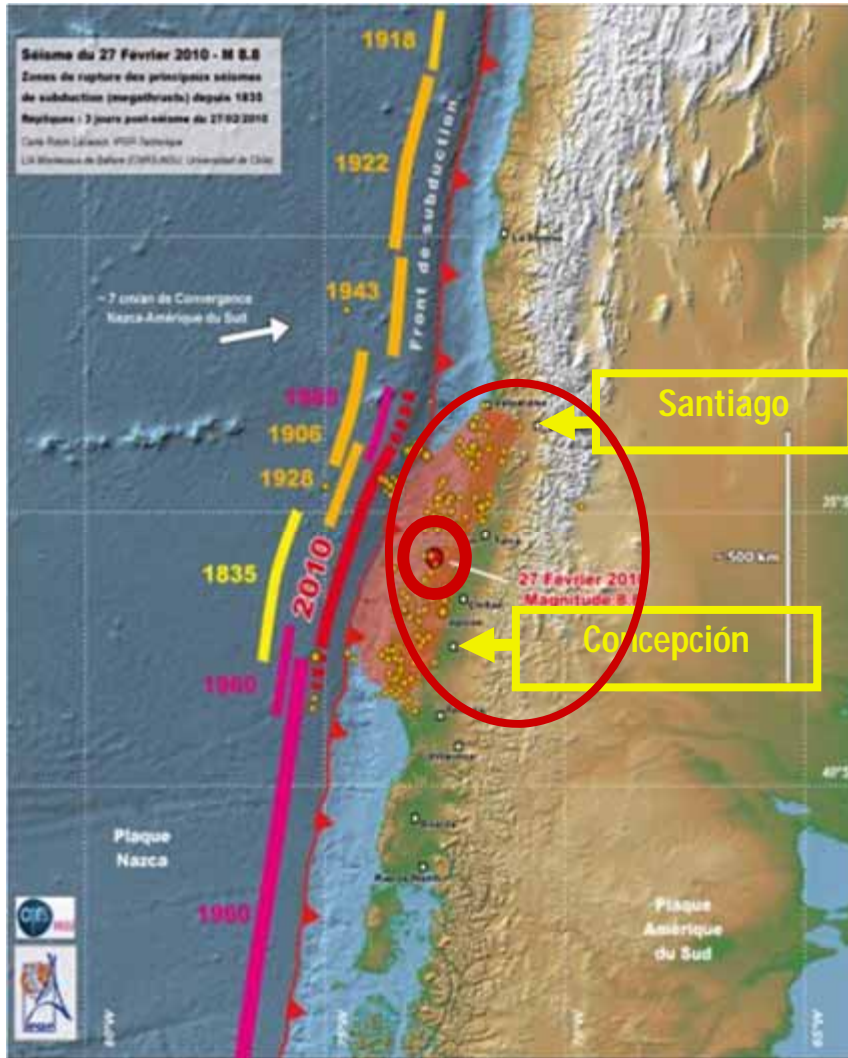

Santiago 245 kV GIS perfectly withstood the major Feb 2010 earthquake, 8.8 magnitude



• Main international stds

- IEEE 693 (1997)
- CEI 62271-2 (2003-02), 60068-3-3 (1991-02), 62155 (2003-05)

• Main national stds

- Chili ETG 1.015 (1993), ETG 1.020 (1997)
- Venezuela ETGS/PAS 001 Rev 01(1999)
- New Zealand TZ 7881, TZ 7967
- Canada SN 29.1a (1990)
- India IS 1893 (1984)
- China GB/T 13540-92

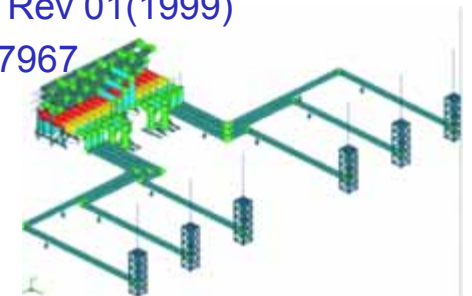

Surrounding conditions

Hazardous areas

12/14
1/1



France – Flandres refinery - 100 kV - GIS and trafos building can withstand a major blast – GIS is split in two parts to improve power availability



Surrounding conditions Under the ground

13/14
1/1



*Canada - 330 kV -
140 m below the
ground surface*

*France – Paris center
245 kV underground GIS*



Surrounding conditions In multi-storeys buildings

14/14
1/1

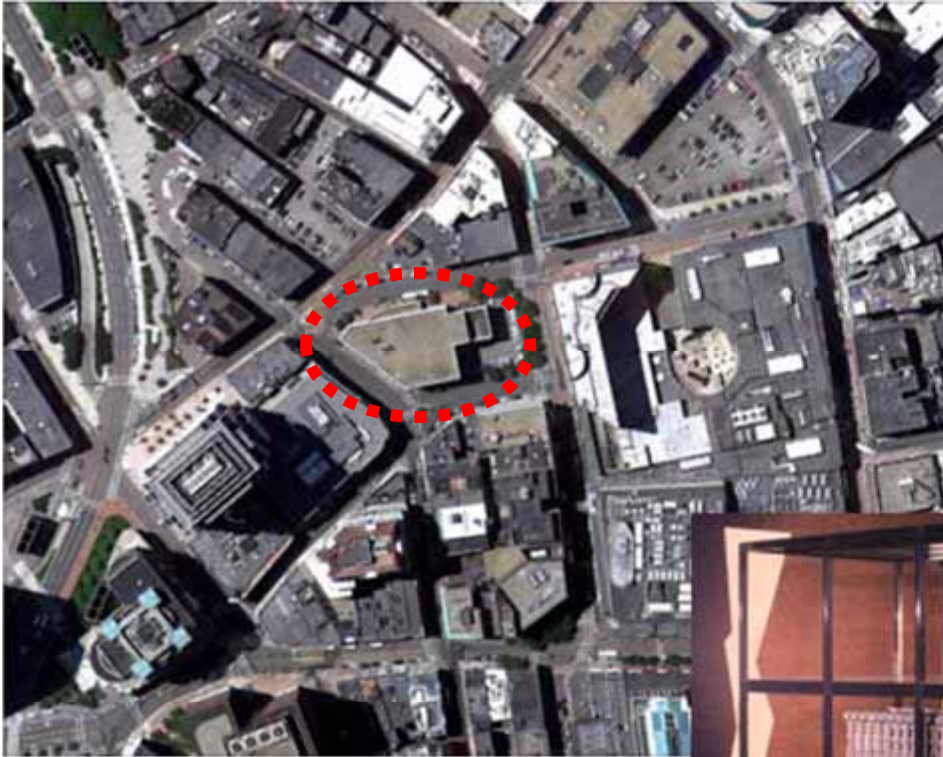

*Boston - Kingston St. -
Power tfrs on ground
floor, 362 kV and 1st
115 kV GIS on floor #1,
2nd 115 kV GIS on floor
#2*

GIS vs. indoor AIS

1/1

- Indoor AIS features several weak points
 - No rain-cleaning of insulators
 - Need to periodically remove dirt, requiring multi-days shutdown
 - Need of heating and ventilation, even sometimes of dryers
 - Internal failure mitigation can raise tough safety issues



69 kV AIS in building – main busbars

Replacing an outdated AIS by a GIS

1/2

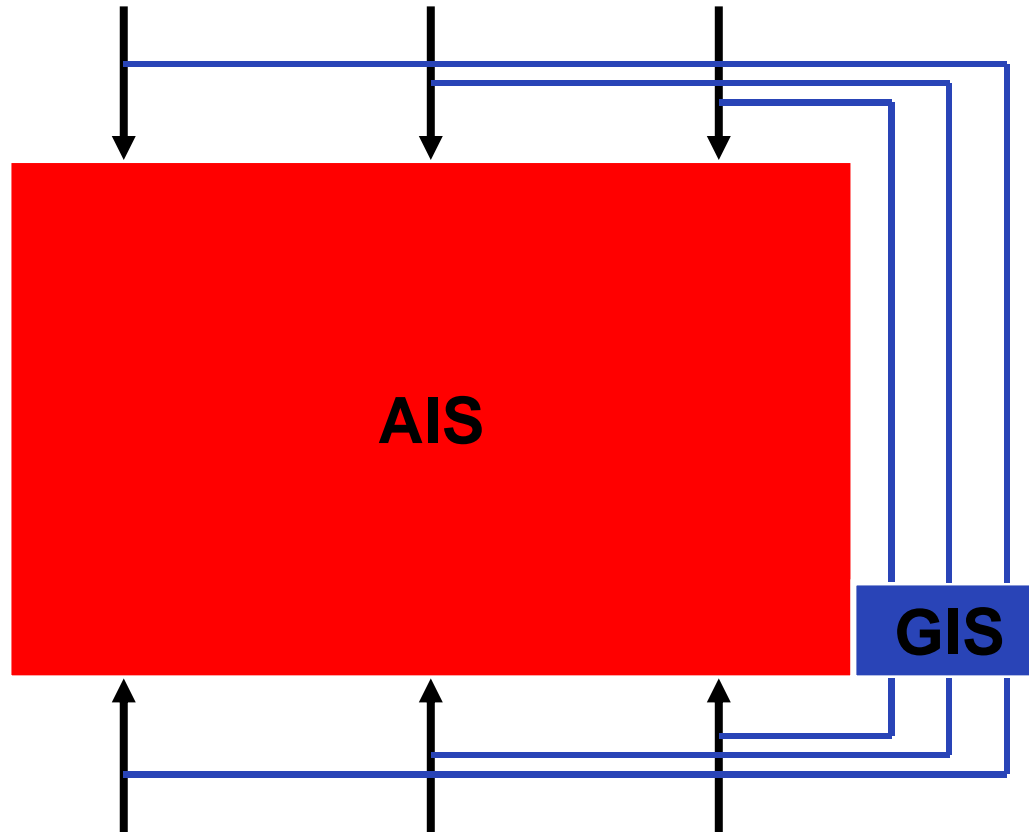

- Associated with HV cables, GIS enables replacing an AIS with minor disturbances
- New GIS is installed and tested while pre-existing AIS remains in operation
- GIS bays are connected, one by one, to lines and transformers
- AIS is eventually removed and its area can be used for any other purpose

Replacing an outdated AIS by a GIS

2/2

- Main topics to go through

- Asset condition
- Site issues
- Health and safety issues
- Operational complexity
- Outage requirements
- System security
- Capital cost
- Resource requirements
- Environmental impact



Temporary HV cables can ensure continuity of operation

Reliability-Availability-Maintainability Overview

1/28
1/2

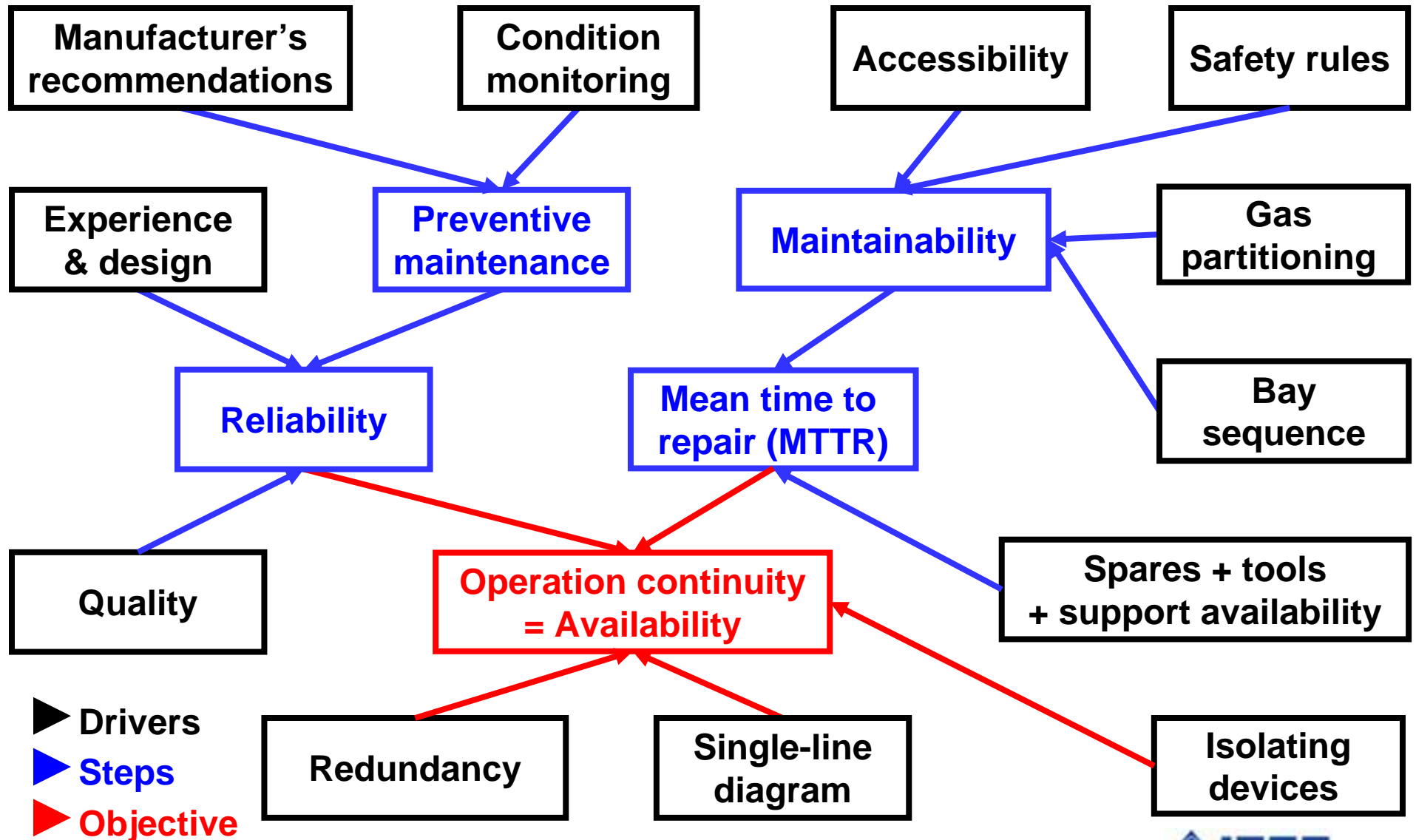

Reliability-Availability-Maintainability Overview

2/28
2/2

- Mitigating a major failure requires to carefully analyze the non-availability (NA) at 3 times
 - Just after the failure
 - Single-line diagram and redundancy are main topics which mitigate NA
 - During the repair
 - Accessibility, safety rules, gas partitioning, bay sequence, spares + tools + support availability, are main topics which mitigate NA
 - NB: repairing a major failure, for instance an internal flashover, generally requires to replace the entire compartment where the failure occurred, including all gas barriers of the defective compartment
 - During the HV tests
 - Isolating devices, jointly with SLD, are main topics which mitigate NA

Reliability-Availability-Maintainability NA upon failure

3/28
1/4

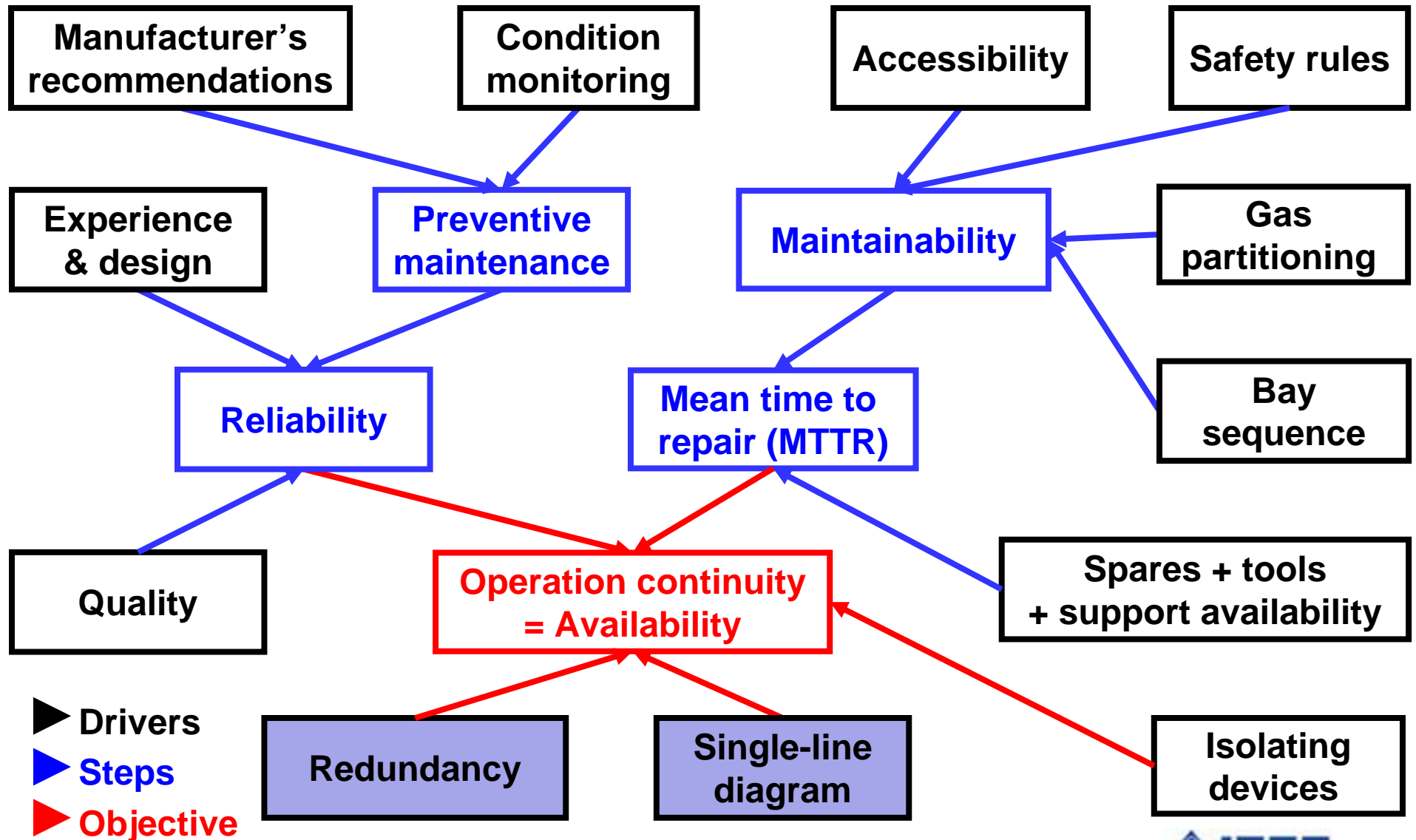

Reliability-Availability-Maintainability NA upon failure

4/28
2/4

- SLD impacts immediate (=just after failure) operation
Mitigation : bypass, transfer bus, BB disconnectors, etc.
 - Single busbar is quite available as soon as redundancy is properly implemented
 - NB: single longitudinal disconnector does not prevent complete busbar shutdown, in case major failure occurs in the said disconnector, as per “Murphy’s law”
 - Double busbar – single CB enables to shutdown no more than one bay, after appropriate switching
 - Ring and 1,5 CB diagrams mitigate CB NA
 - Drawback: all CBs operate twice more (center CB only in 1,5 CB)
 - Transfer busbar shall have same availability level as main busbar(s)
- NA of different SLD’s shall be assessed later on in this presentation

Reliability-Availability-Maintainability NA upon failure

5/28
3/4

- SLD's with a single CB per feeder
 - Intended to balance investment and availability
 - Easier network management

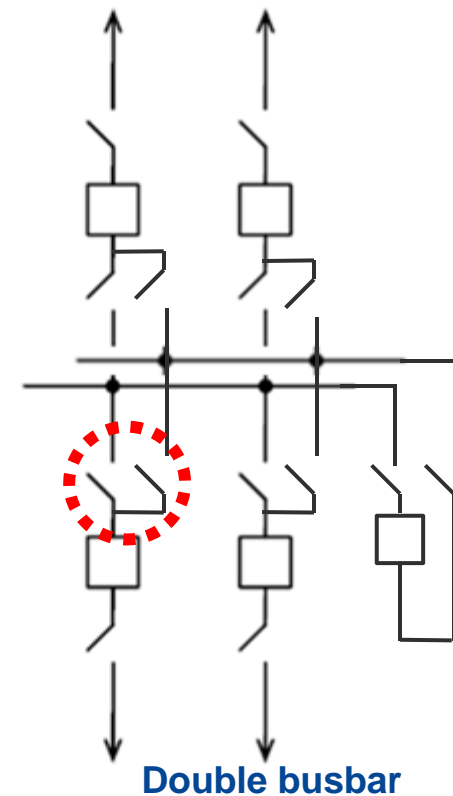
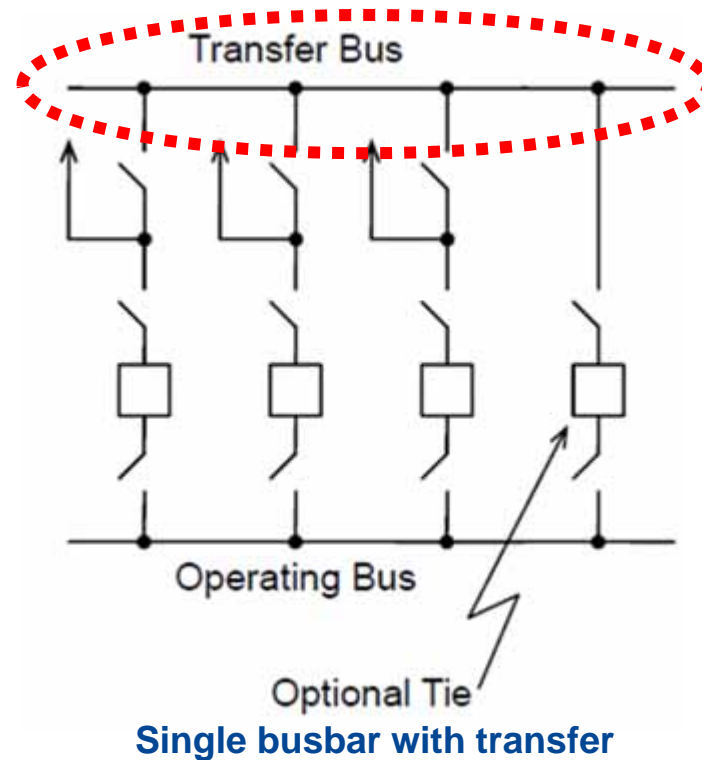
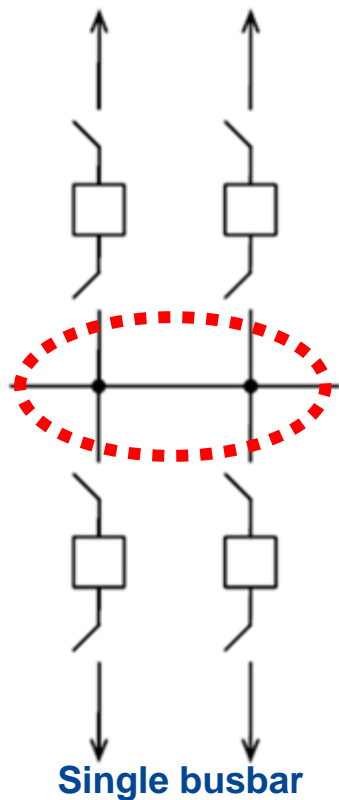

Reliability-Availability-Maintainability NA upon failure

6/28
4/4

- SLD's with two CB 's or more per feeder
 - Intended to mitigate CB failure

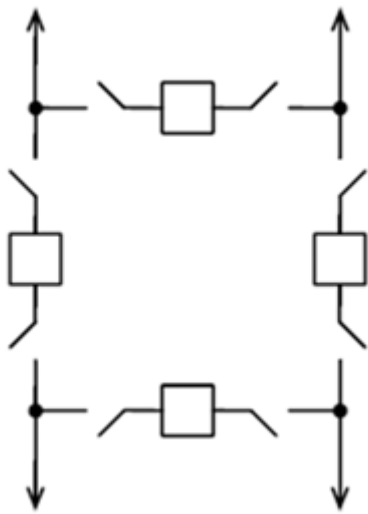

Ring busbar

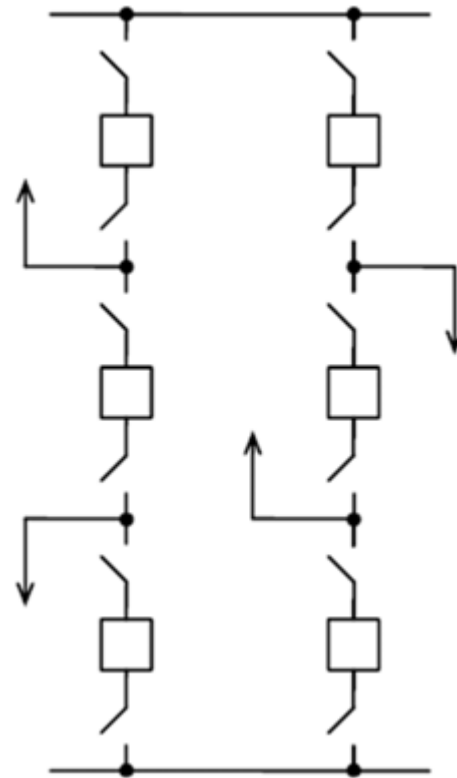

One circuit-breaker and a half

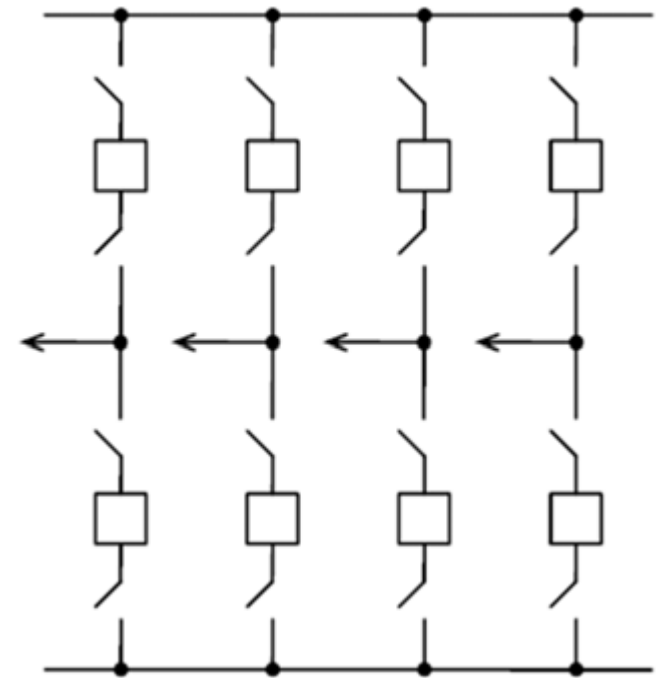

Double busbar -
double circuit-breaker

Reliability-Availability-Maintainability NA upon repair

7/28
1/7

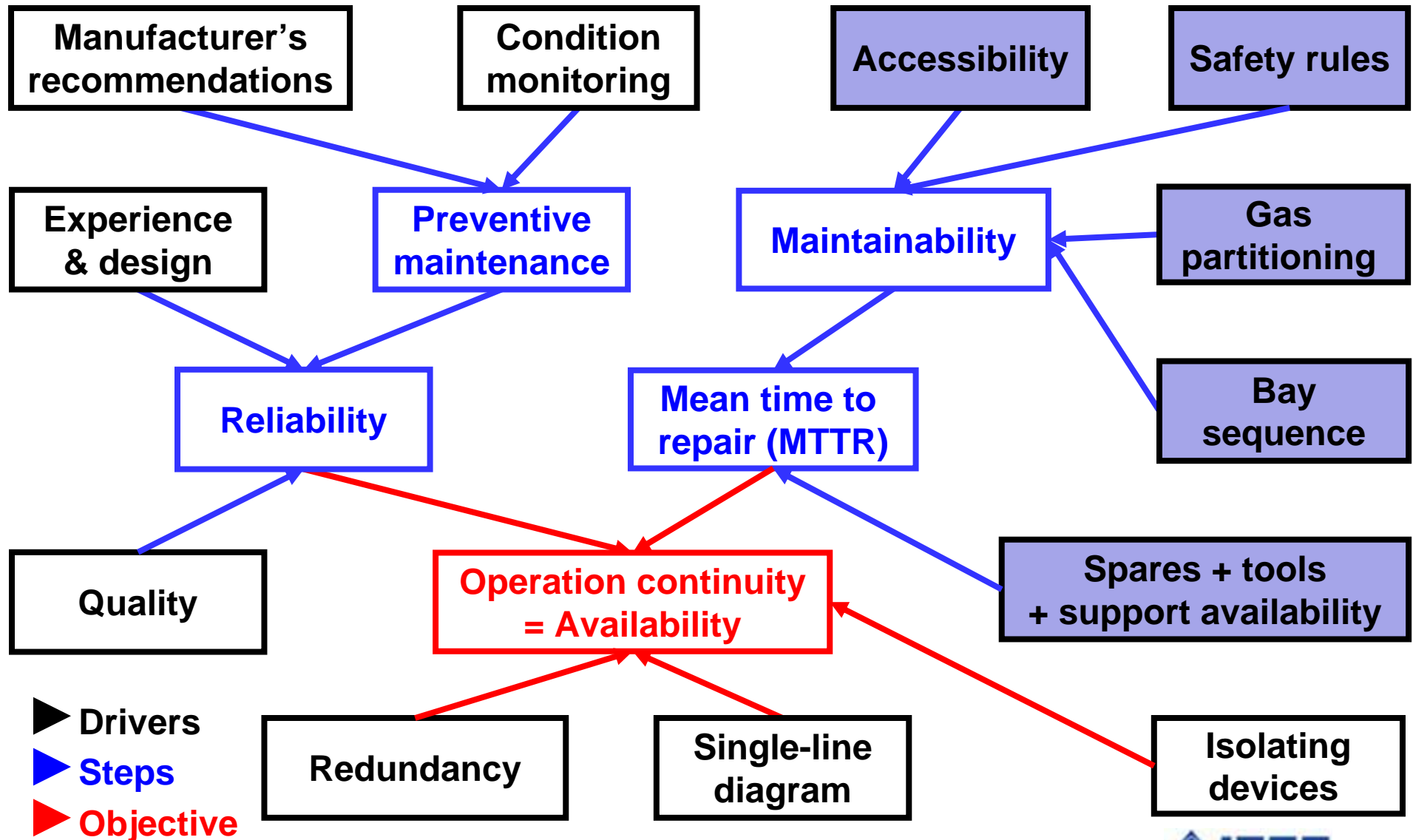

- ▶ Drivers
- ▶ Steps
- ▶ Objective

Reliability-Availability-Maintainability NA upon repair

8/28
2/7

- Accessibility

- Despite commonplace, this matter shall be carefully consider, in order to avoid “domino effect”

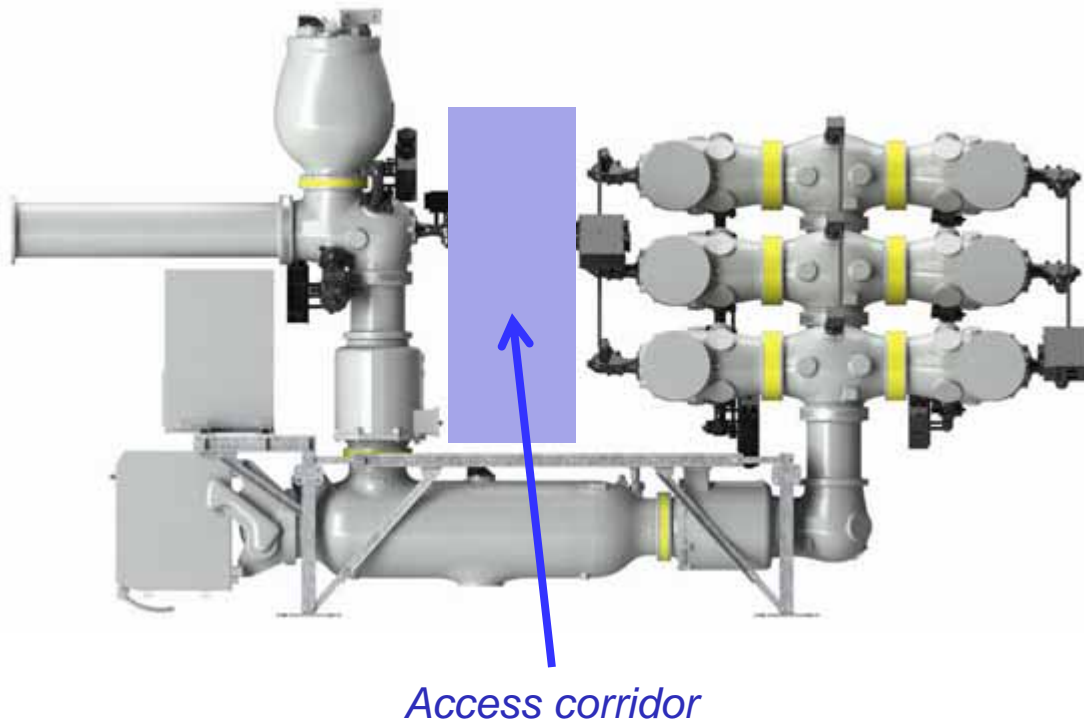

Reliability-Availability-Maintainability NA upon repair

9/28
3/7

• Safety rules

- Specific safety rules : no additional mechanical stress shall be applied to any pressurized gas-barrier
- Any component removal – with its gas barriers - requires to de-energize, then de-pressurize all adjacent electrical circuits

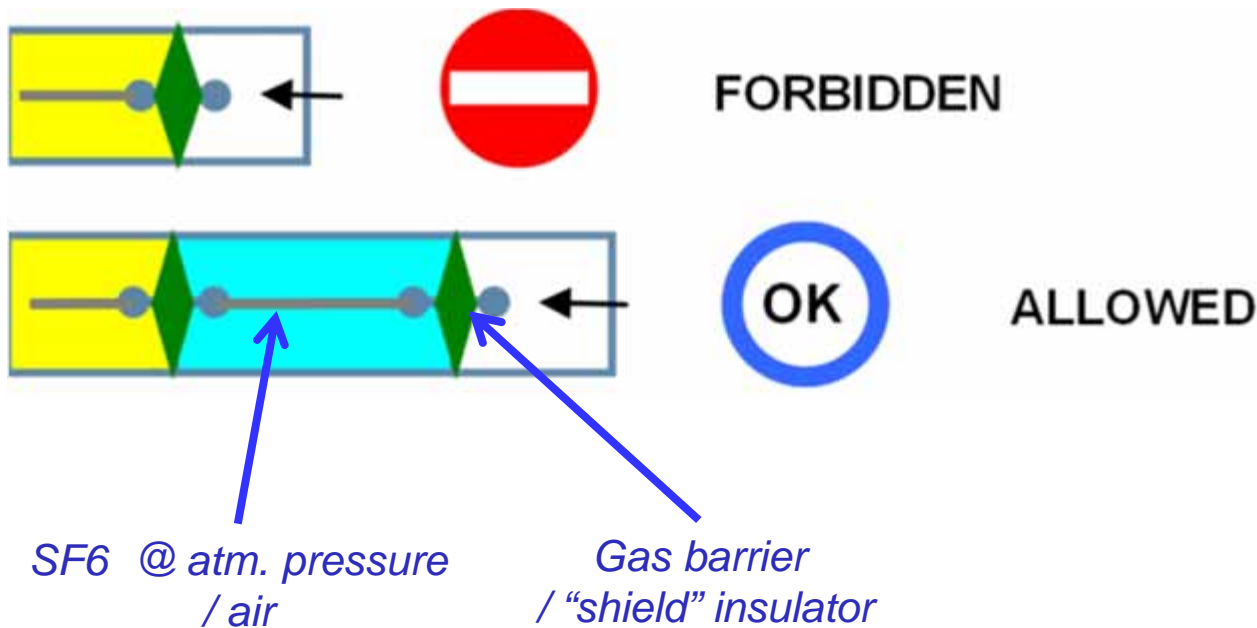

Gas barrier

Reliability-Availability-Maintainability NA upon repair

10/28
4/7

- Safety rules

- Safety rules and gas partitioning deeply impact the repair process
- Repair process impacts compartments close to repair zone and can require complete substation shutdown

Mitigation : partitioning and shield insulators

Reliability-Availability-Maintainability NA upon repair

11/28
5/7

- Gas partitioning - Case 1: non-partitioned main busbar
 - Replacement of just one faulty busbar disconnecter, or one circuit-breaker, can require to shutdown the complete substation
 - Reasoning made of “passive” components is wrong, since many items, such as sliding conductors, and grounding switches, are actually as “active” as anywhere else in the GIS

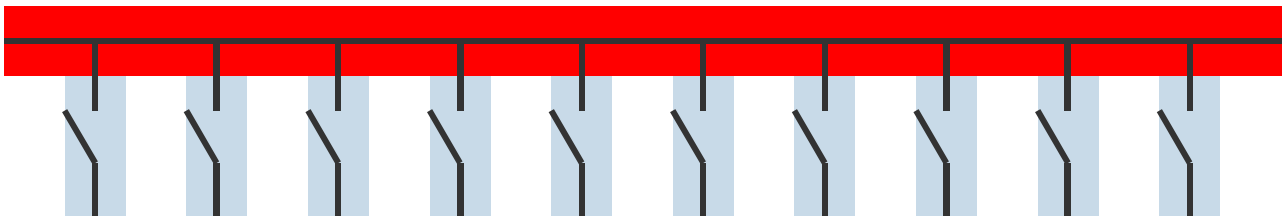

Partitioning concept to avoid

Main busbar failure repair requires to drain all busbar isolators

=> Complete substation shutdown during repair

Reliability-Availability-Maintainability NA upon repair

12/28
6/7

- Gas partitioning - Case 2: partitioned main busbar
 - Partitioned main busbar enables to limit the impact of a major failure to a small compartment and subsequently decrease the repair time

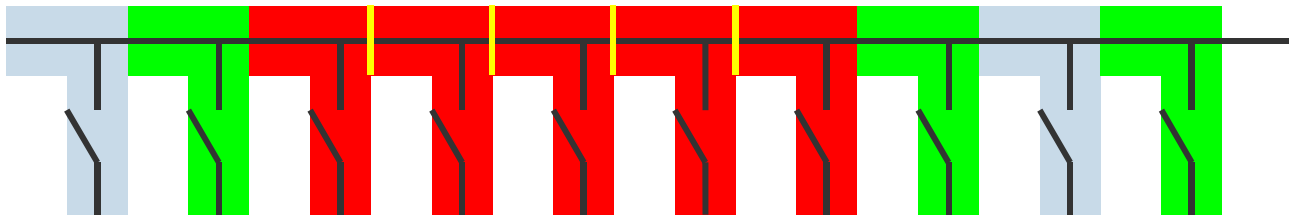

*Medium-class partitioning
=> 5 bays shutdown
during repair*

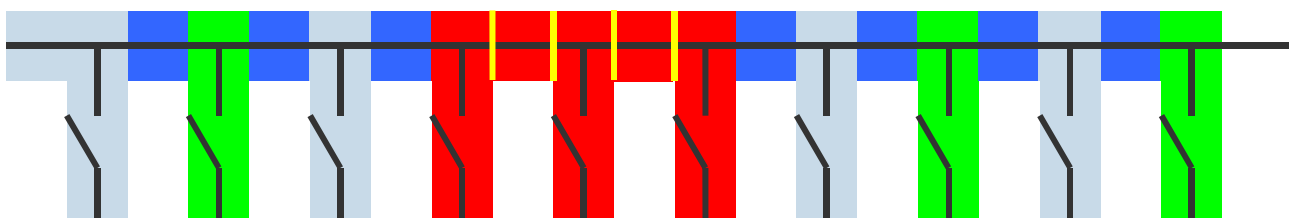

*Medium-class partitioning
=> 3 bays shutdown
during repair*

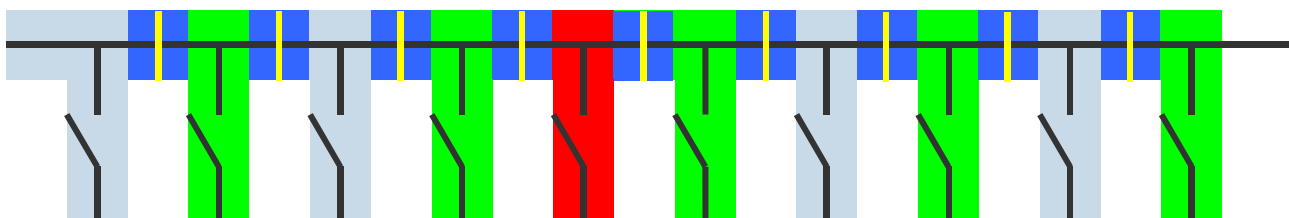

*Best partitioning
=> Single bay shutdown
during repair*

Reliability-Availability-Maintainability NA upon repair

13/28
7/7

- Availability of spares, tools and support staff
 - This issue is quite too often disregarded at tender stage
 - Despite a very high MTTR, “Murphy’s law”, again, can apply
 - It can drastically impact repair time and revenues
 - GIS life expectancy is significantly longer than AIS
 - Spares
 - Supply time is ranging from zero, when stored in GIS room, to more than 6 months, when equipment is phased out
 - Selection depends on SLD
 - Tools
 - Tools will be consistently made available, versus spares
 - Capital spares generally require special tools
 - Support staff
 - Only large organizations can have continuously and sufficiently trained staff, otherwise manufacturer’s support is a must

Reliability-Availability-Maintainability NA during HV tests

14/28
1/5

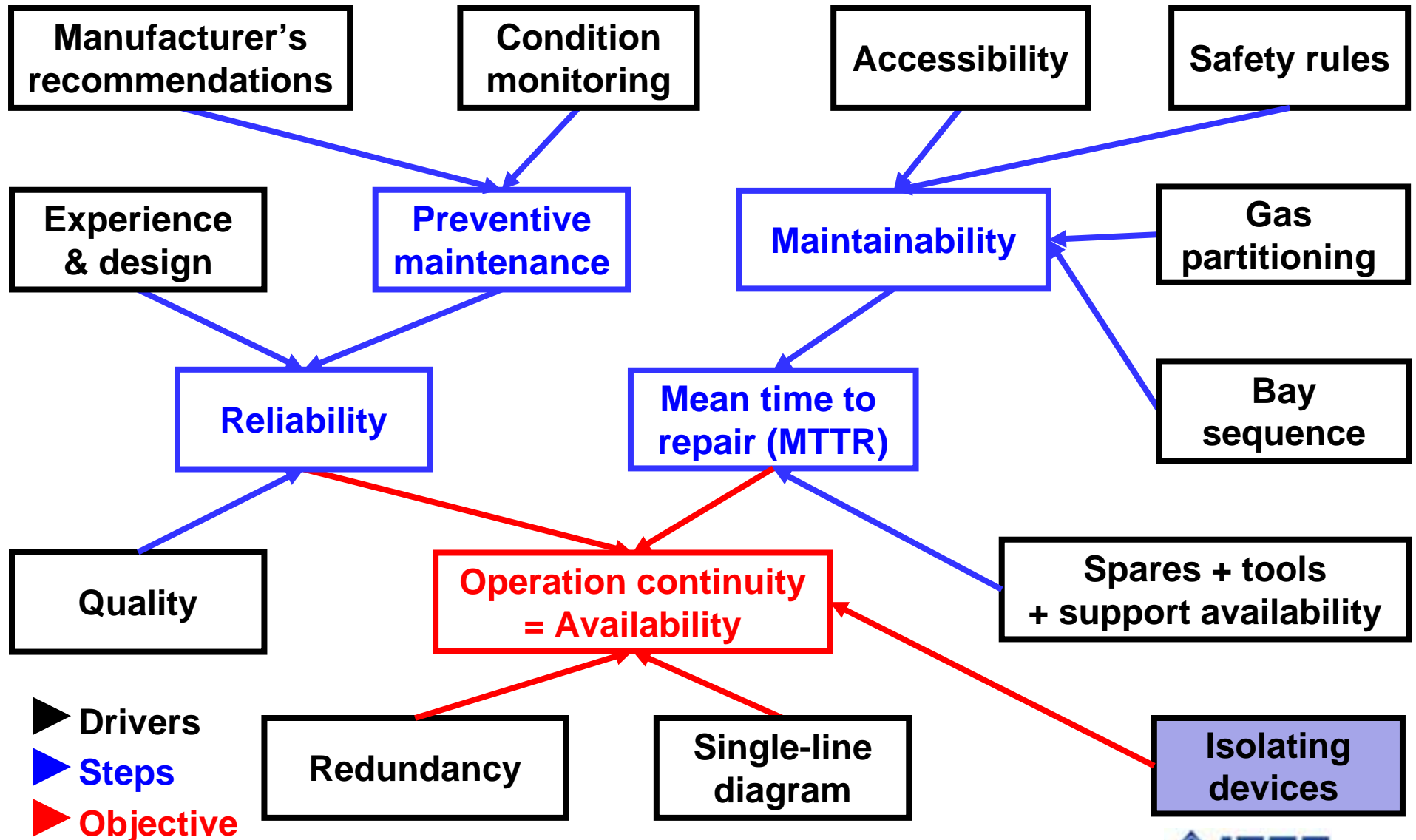

Reliability-Availability-Maintainability NA during HV tests

15/28
2/5

- HV tests impact
 - GIS features short clearances and high electric fields
=> High-voltage tests are mandatory to ascertain reliable operation after heavy maintenance
 - Disconnectors cannot withstand network voltage on one terminal while the other terminal is connected to HV test voltage
 - Without specific features, such as additional isolating gaps, HV tests can require to de-energize the complete substation
- Mitigation
 - Double isolating gap between tested (shutdown) busbar and the other busbar
 - Isolating devices: implemented transversally (e.g. MID) or longitudinally (e.g. busbar longitudinal disconnectors)

Reliability-Availability-Maintainability NA during HV tests

16/28
3/5

- Longitudinal isolating devices

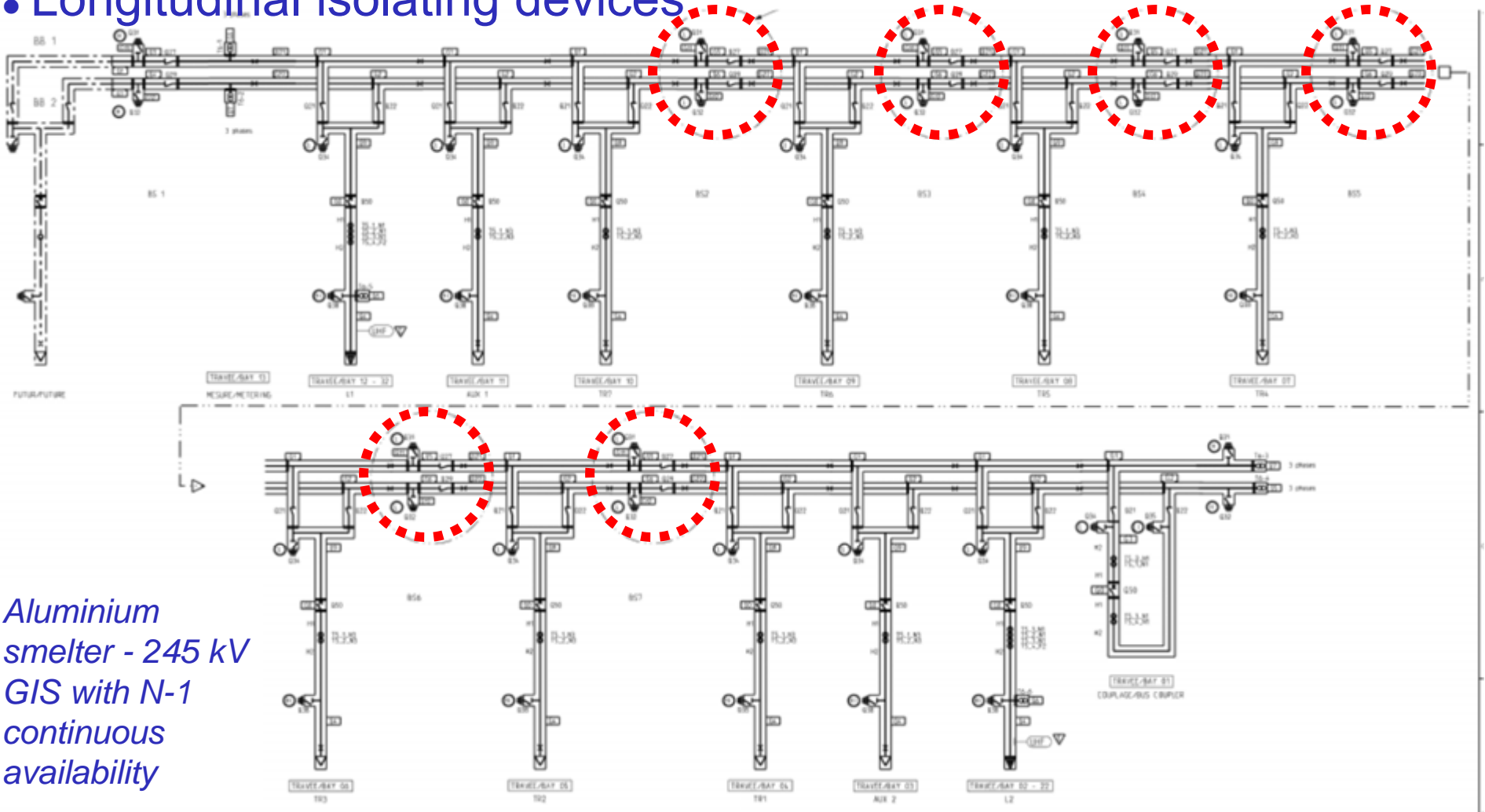

*Aluminium
smelter - 245 kV
GIS with N-1
continuous
availability*

- Transversal isolating devices

- MID provides an additional gap between main busbar isolator and CB
- Operation must be achieved from the outside, with no degassing, in order to shorten the repair process and prevent the need of further HV tests

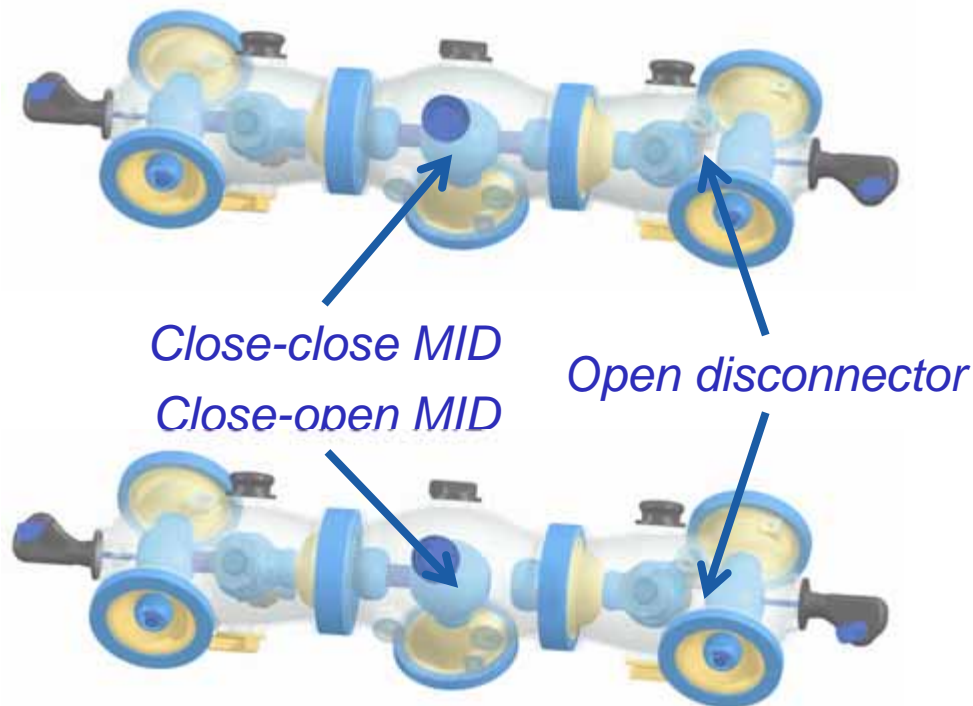

Double busbar common point assembly with close-close MID (normal position)

Double busbar common point assembly with open-close MID (right-side double gap)

Reliability-Availability-Maintainability NA during HV tests

18/28
5/5

- Maintenance isolating device (MID) drastically improves GIS availability during maintenance, repair, HV tests and extension
 - MID mainly provides a second disconnecting gap, in order to continuously operate all bays but one, even during HV tests
 - MID provides 3 positions
 - Both gaps closed : normal operation
 - Left gap open : right bus remains energised
 - Right gap open: left bus remains energised
- MID cuts undelivered energy costs, and subsequently reduces TCO

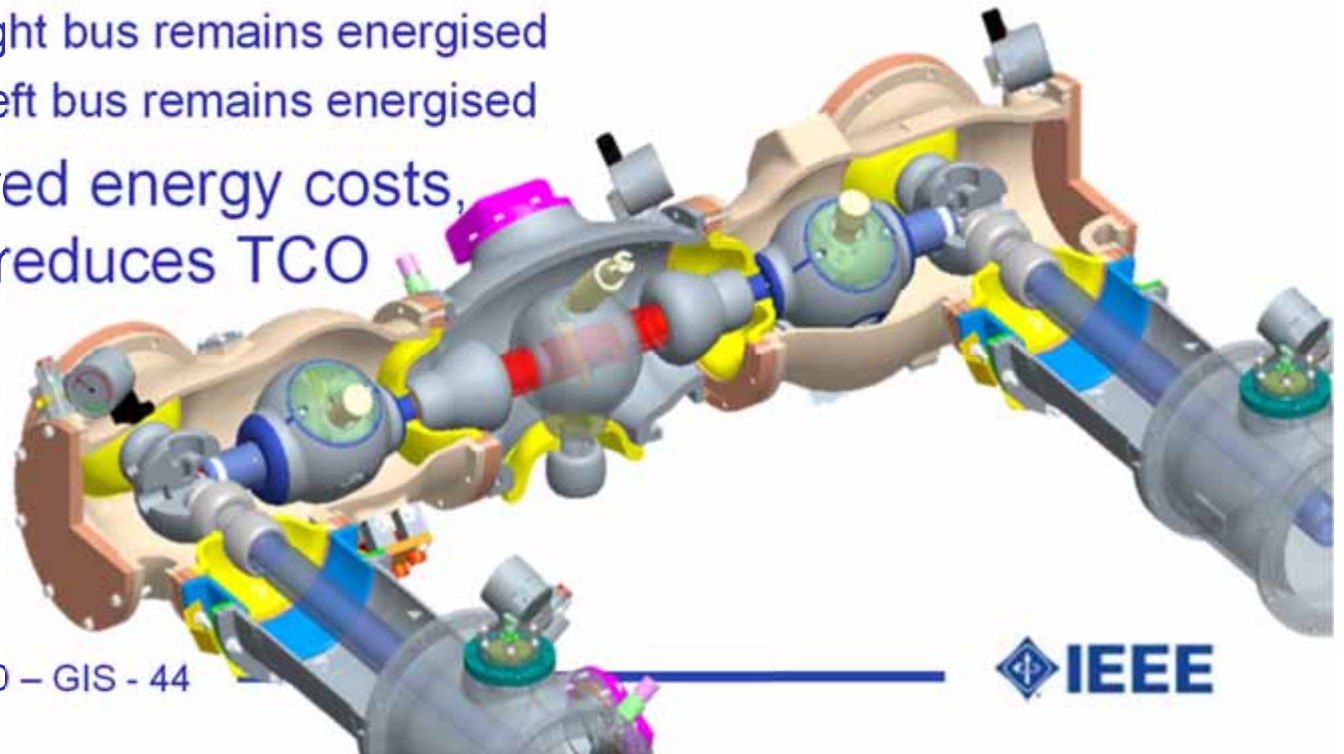

Reliability-Availability-Maintainability

Availability assessment

19/28
1/10

- Non-availability (NA) of a circuit is the sum of the non-availabilities of each item of such circuit
- Ground data are the numbers of failures and sample size recorded in the CIGRE brochure titled “Report on the second international survey on high voltage gas insulated substations (GIS) service experience”, dated February 2010.
- Presentation is focused on 145 kV data

Reliability-Availability-Maintainability Availability assessment

20/28
2/10

Voltage class (kV)	1	2	3	4	5
2BB bay MTBF (y)	500	200	125	28	22
3ph. CB	4	31	14	20	4
3ph. CB mech.	5	32	14	20	5
3 ph. DS	1	24	11	20	10
3 ph. ES	1	9	8	1	1
3ph. CT	1	3	1	1	1
3ph. VT	2	19	5	1	1
Cable / TA / Tfo connect	1	8	7	11	6
Sigma	15	126	60	74	28
Voltage range (kV)	60-100	100-200	200-300	300-500	500-700

	CIGRE data	%	NCF nb. of failures	NCY nb. of comp. *years	FR failure rate (1/y)	MTBF (year)	Failure MTTR (hour)	Failure SDTR
300-500 kV voltage class - Failure MTTR= 15 days	1 m of 3ph. busduct	0	0	0	0,0000	0	360	
	3ph. CB	20	27	27	2 800	0,0097	104	360
	3ph. CB mech.	20	27	27	2 800	0,0097	104	360
	3 ph. DS	20	27	27	8 400	0,0032	311	360
	3 ph. ES	1	1	1	11 200	0,0001	8 288	360
	3ph. CT	1	1	1	2 800	0,0005	2 072	360
	3ph. VT	1	1	1	2 800	0,0005	2 072	360
	Cable / TA / Tfo connect	11	15	15	2 800	0,0053	188	360
	x	0	0	0	0	0,0000	0	360
	Sigma	74	100	100	2 800	0,0357	28	

imm. / repair / tests	Item	NA (ppm)	SBB-1 feeder without buffer	SBB-half GIS without buffer	DBB-1 feeder without buffer	DBB-overall GIS without buffer	1CB1/2-1 feeder without buffer	1CB1/2-2 feeders without buffer
Immediate NA	1 m of 3ph. busduct	0						
	3ph. CB	397	1		1			
	3ph. CB mech.	397	1		1			
	3 ph. DS	132	3	3	3		3	
	3 ph. ES	5	4	4	3		4	
	3ph. CT	20	2	1	1		1	
	3ph. VT	20	2	1	1		1	
	Cable / TA / Tfo connect	218	1		1		1	
	x	0						
	Total			1 507	456	1 463	0	674
Additional NA during repair	1 m of 3ph. busduct	0						
	3ph. CB	132	2	3	6	7	3	2
	3ph. CB mech.	79						
	3 ph. DS	44			10	12		
	3 ph. ES	2			5	6		
	3ph. CT	7		2			2	2
	3ph. VT	4						
	Cable / TA / Tfo connect	44						
	x	0						
	Total			264	410	1 242	1 464	410
Additional NA during HV tests	1 m of 3ph. busduct	0	0	0			0	0
	3ph. CB	26	3	3			0	0
	3ph. CB mech.	26					0	0
	3 ph. DS	9	3	3	2	2	3	0
	3 ph. ES	0	4	4	4	4	4	0
	3ph. CT	1	2	3			3	2
	3ph. VT	1	2	1	2	2	1	0
	Cable / TA / Tfo connect	15	1	0			1	0
	x	0	0	0			0	0
	Total			127	112	22	22	48

Reliability-Availability-Maintainability

Availability assessment

21/28
3/10

- Assessed SLD's
 - Single busbar
 - Double busbar – single CB
 - Double busbar – single CB with bypass
 - Double busbar – single CB with transfer busbar
 - One and a half circuit-breaker

Reliability-Availability-Maintainability

Single-line diagram availability assessment

22/28
4/10

- Bus coupler (double busbar SLD)
 - Coupler is a circuit-breaker bay which normally features one CT on either CB side in order to provide the appropriate BB protection (87N)
 - Coupler CB shall usually be replaceable while at least one BB remains energized during the repair
 - The later requires to have one buffer compartment between CB and one busbar isolator

Reliability-Availability-Maintainability

Single-line diagram availability assessment

23/28
5/10

- Bus tie

- Bus tie is a circuit-breaker bay which normally features one CT on either CB side in order to provide the appropriate BB protection (87N)
- Single busbar diagram:
 - No special gas partitioning is usually required, despite any bus tie CB repair/HV test would shutdown the entire substation
- Double busbar diagram:
 - No special gas partitioning is usually required

Reliability-Availability-Maintainability

Availability assessment

24/28
6/10

- Single busbar

- 2*6 CB bays with double busbar isolator (full redundancy)
- Sectionalized (double DS) single busbar is acceptable, for industrial application, when full redundancy is implemented

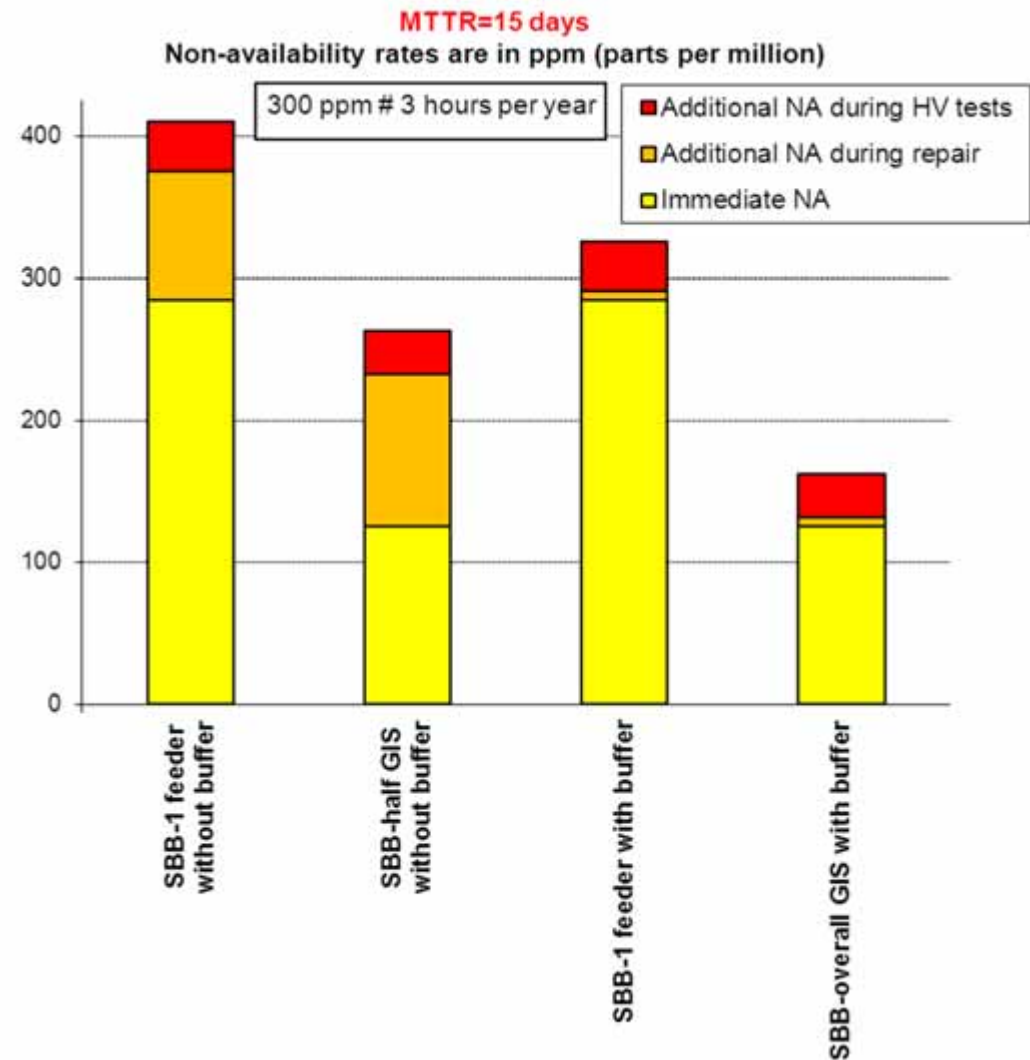

Reliability-Availability-Maintainability

Availability assessment

25/28
7/10

• Double busbar

- 6 feeders + 1 coupler
- Buffers significantly decrease NA
- With no availability features, double busbar is not that much better than single busbar
- With availability features, double BB is much better than single BB
- Appropriate partitioning mitigates repair NA but does not mitigate HV tests NA
- Isolating devices (when they do not require compartment opening and gas treatment) mitigate HV tests NA

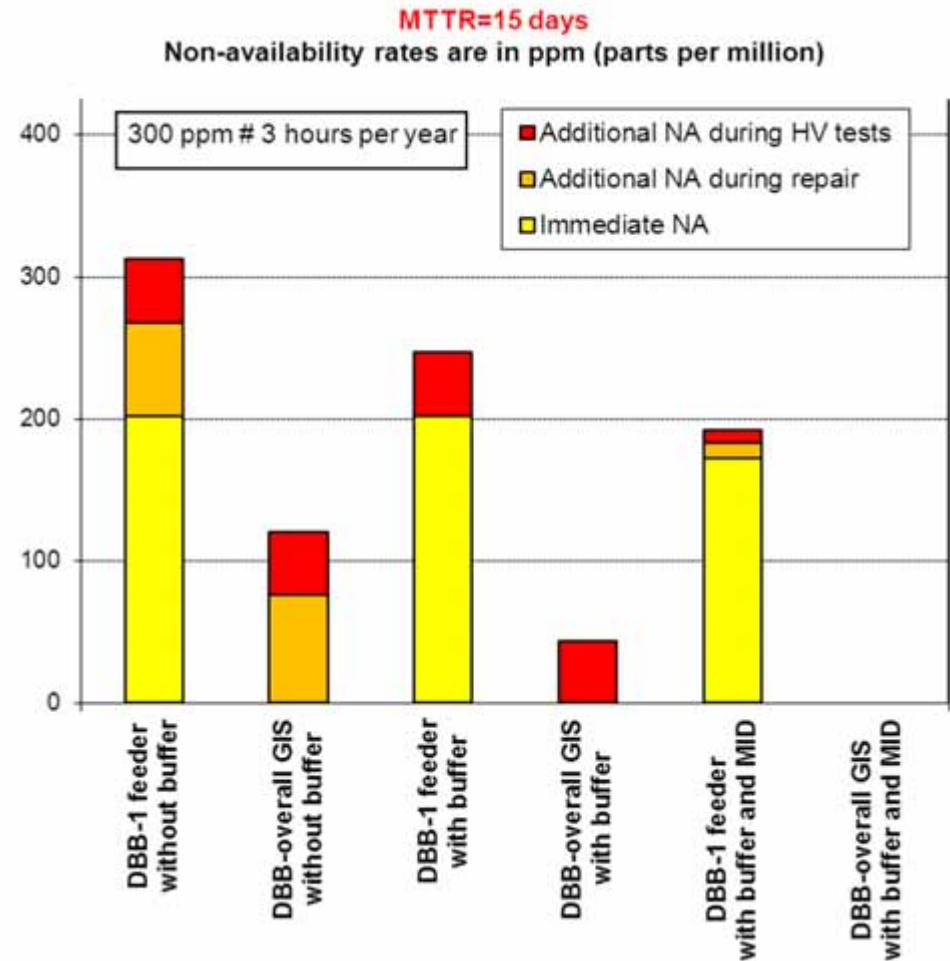

Reliability-Availability-Maintainability

Availability assessment

26/28
8/10

- One and a half circuit-breaker / ring diagram
 - No actual event can jeopardize the entire GIS
 - However, some events can shutdown two feeders at a time
 - Buffers decrease NA
 - One ½ CB still features significant NA, since center CB operates twice more often than a CB in single/double bus SLD
 - The latter is even more detrimental for any CB in a ring diagram

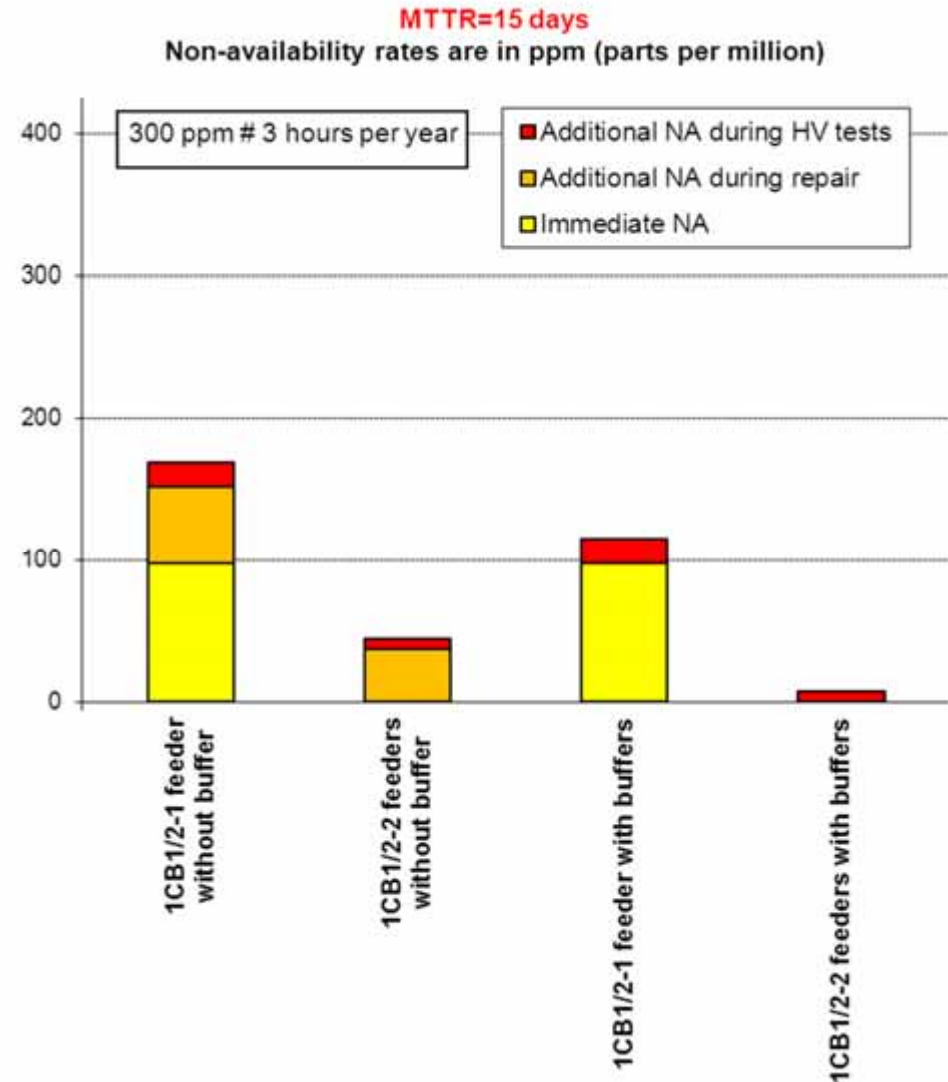

Reliability-Availability-Maintainability

Availability assessment

27/28
9/10

- Double BB with transfer BB
- Double BB with bypass
 - Equivalent SLD's in terms of NA
 - Still complete substation can be shutdown

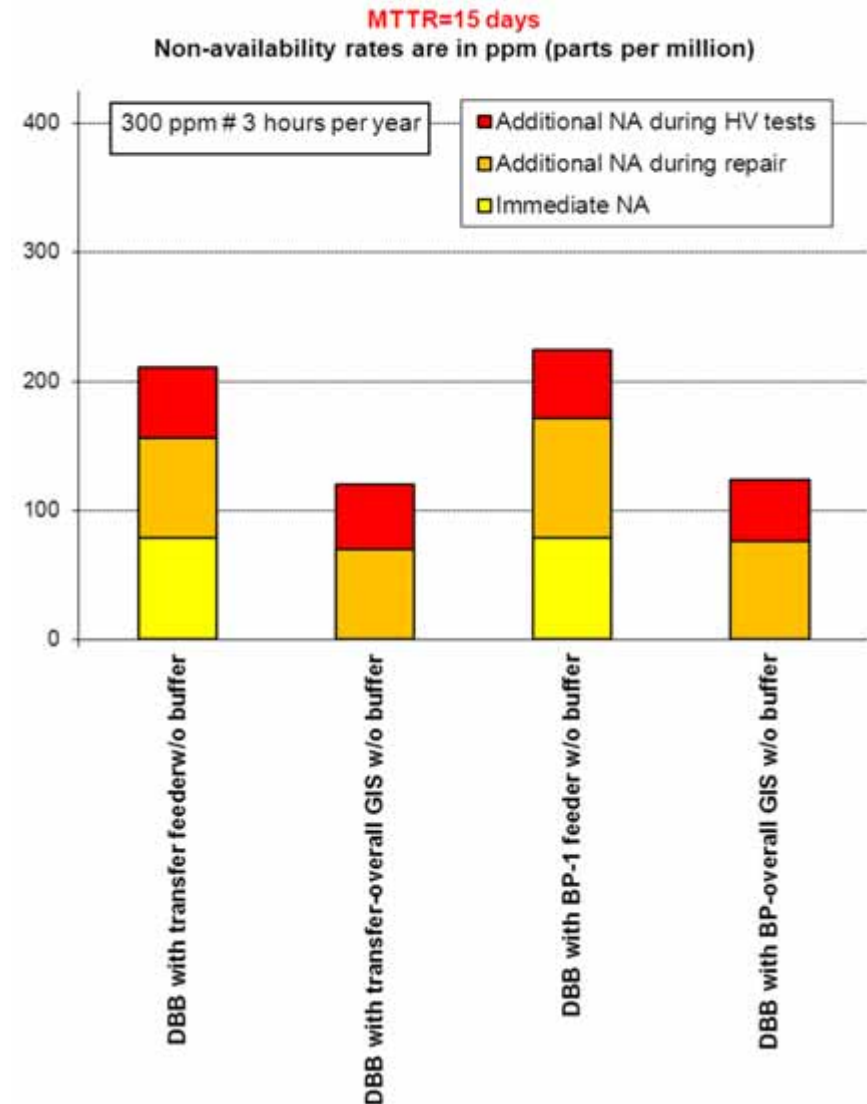

Reliability-Availability-Maintainability

Single-line diagram availability assessment

28/28
10/10

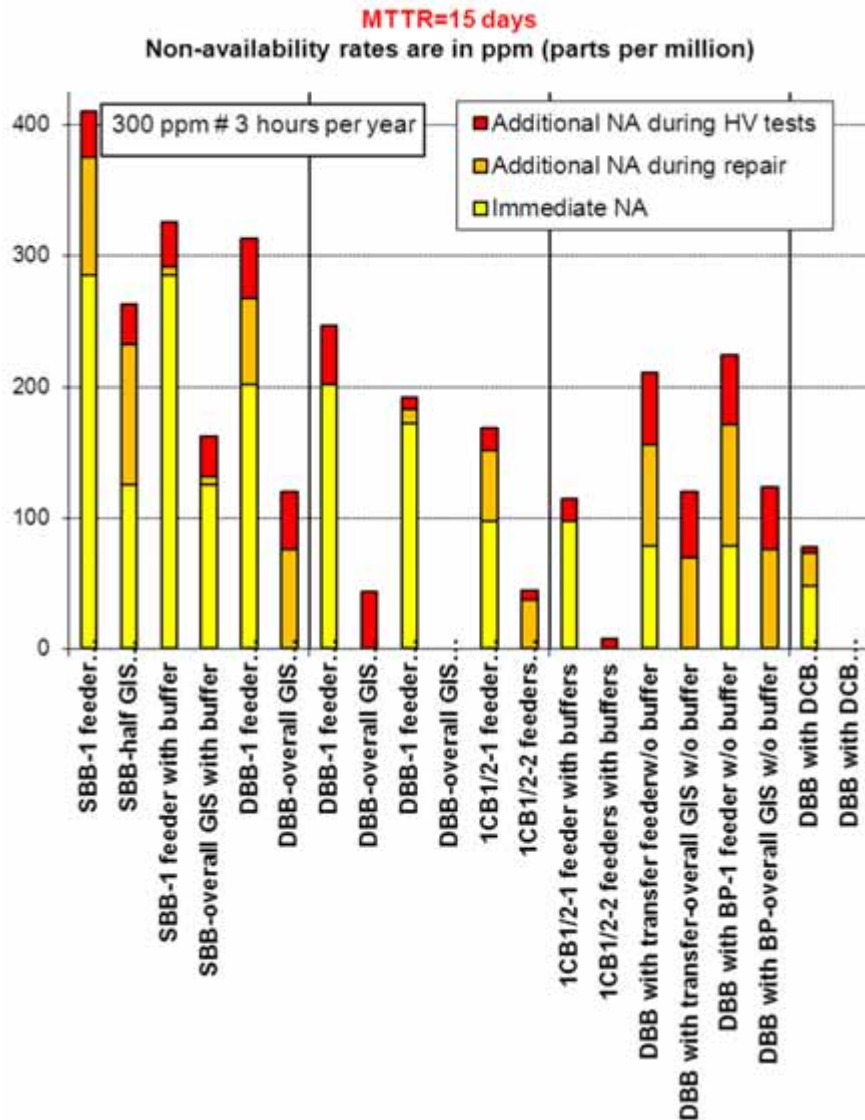

Notice: spares and tools delivery time can be extensive

Your questions and comments are welcome !



List of contents

Session 2 – April 9th, 2014

- Civil interfaces
- Buildings
- High-voltage interfaces
- Low-voltage interfaces
- GIS elements
- Monitoring
- Project execution process
- The “digital substation”

Civil interfaces

Important features to consider

1/3
1/3

- Building
 - Concrete slab planarity
 - Dilatation joints / slab size
 - Wall columns distance
 - Accommodate GIB wall hatches
 - Floor beams distance
 - Accommodate HV cable floor hatches
 - LV cables hatches / trenches / trays
 - Grounding: 80-2000 - IEEE Guide for Safety in AC Substation Grounding
 - Unloading area

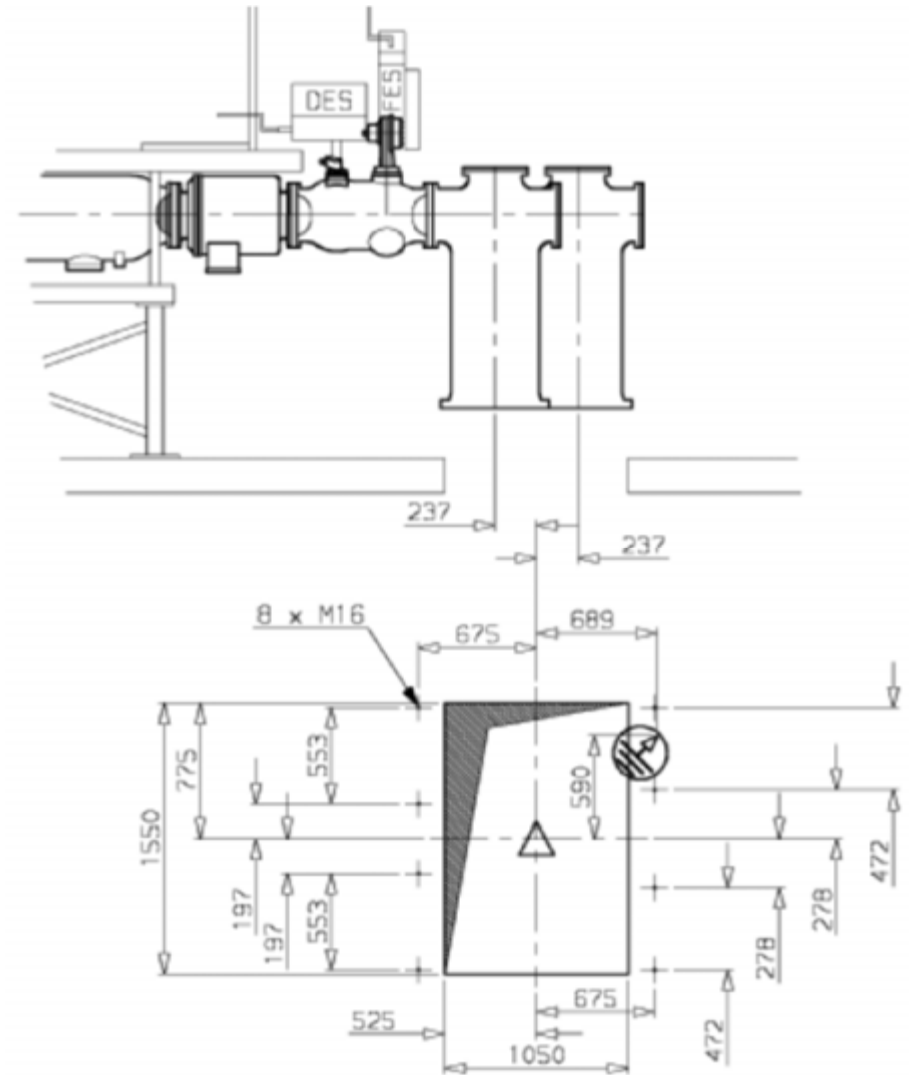
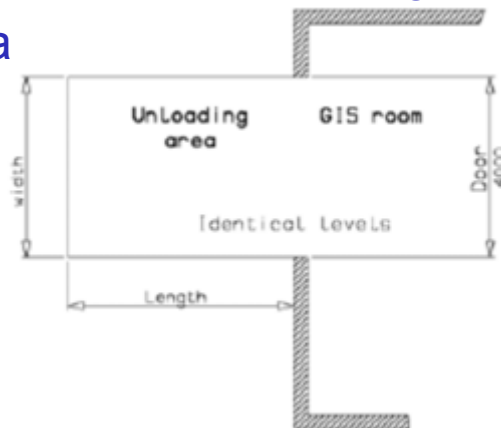

Civil interfaces

Important features to consider

2/3

2/3

- Outdoor civil works (CW)
 - Ground settlement
 - Trenches, pipes, etc.
 - Access, clearances
 - Water drainage
 - Grounding

CW movements AFTER GIS erection (h_4 , h_5 , ω , Θ , E_0)

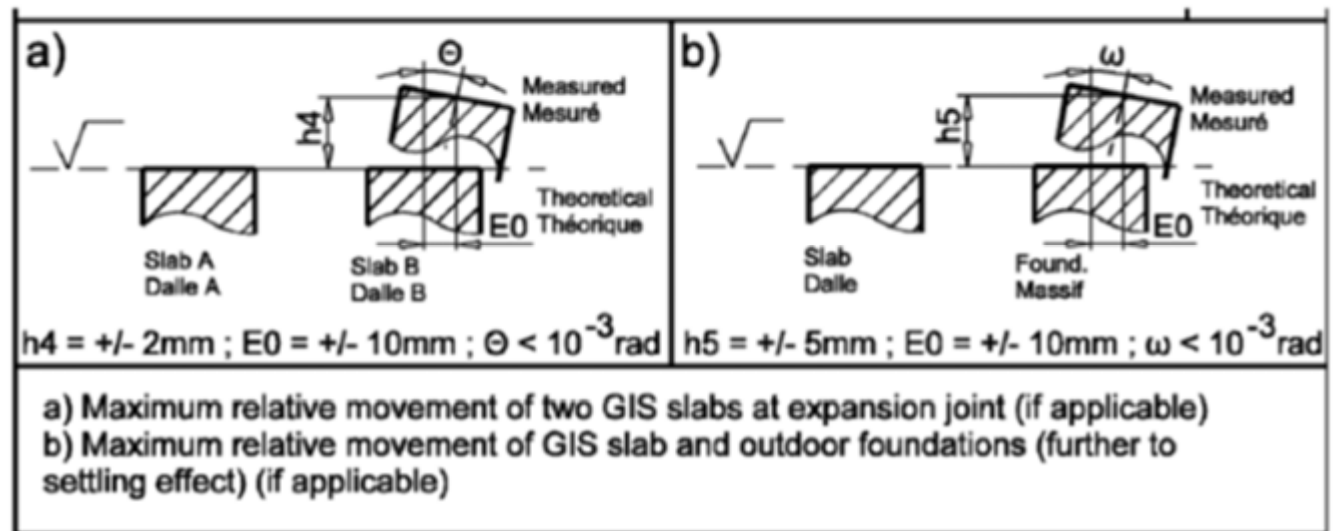

Civil interfaces

Important features to consider

3/3
3/3

- Floor design
 - Accommodate CB dynamic loads
 - Floor flexibility shall be avoided to prevent excess movements which stress live parts

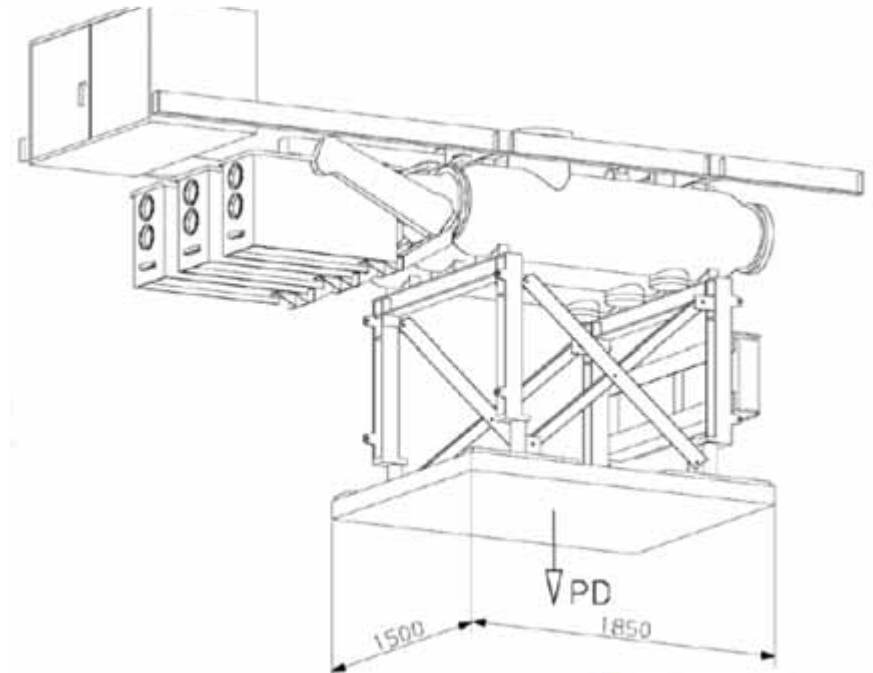
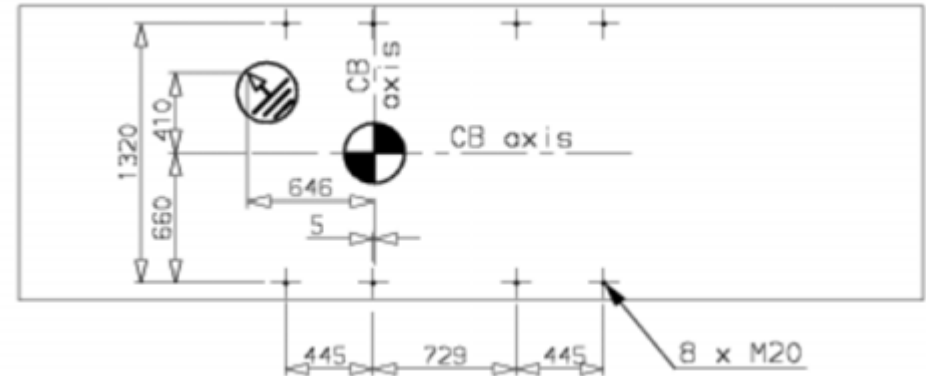

Natural frequency of GIS slab (Hz)	Equivalent static load (kN)
4,5	17
7,5	63
10,5	189
12,0	210
18,8	210
22,5	126
30	76
60	50

Buildings

Conventional brick / concrete building

1/6
1/1



Switzerland – Oberuzwill – 145 kV



Buildings

Steel frames and panels building

2/6
1/1



Switzerland – Wimmis - 72 kV



*USA – Port
Arthur – 69 kV*

Buildings

Prefabricated electrical building - steel

3/6

1/1



Canada – Jackpine – 13 CB bays in a steel PEB

Buildings

Prefabricated electrical building - concrete

4/6

1/1



*France - Lussagnet - 72 kV - gas liquefaction plant
Complete bay, including protection, control and LV auxiliaries was installed within a couple of days*

- Concrete PEB can hardly accommodate more than a few bays
- Associated to a prefabricated basement
- Resilient design

Buildings

Mobile substation

5/6
1/1



Algeria – 245 kV mobile substation

- Mobile substations can
 - Be rated up to 362/420 kV
 - Accommodate up to 4 bays
 - Integrate both GIS and transformer, up to 145 kV



Spain – 145 mobile substation – 4 CB

Buildings Shelter

6/6
1/1



*Malaysia –
Pergau –
245 kV*

HV interfaces

SF6-air bushing

1/5
1/1

- Features to specify
 - Ambient temp range
 - Earthquake withstand
 - Voltage withstand
 - Insulator material
 - Porcelain, composite
 - Creepage distance
 - Based on phase-to-phase voltage
 - Mechanical loads
 - Altitude a.s.l.
 - Terminal material and dimensions
 - IEC 60137-2008 std.



India – Bhavini – 245 kV

HV interfaces

HV cable connection

2/5
1/2

- Features to specify
 - IEC std no. 62271-209
 - To avoid tough site difficulties
 - Cable termination types
 - Dry-type, plug-in / Fluid-type, not plug-in
- Important issues
 - Bending radius
 - Cable laying/support
 - GIS test requirements
 - Cable disconnection during tests



72 kV plug-in cable terminations

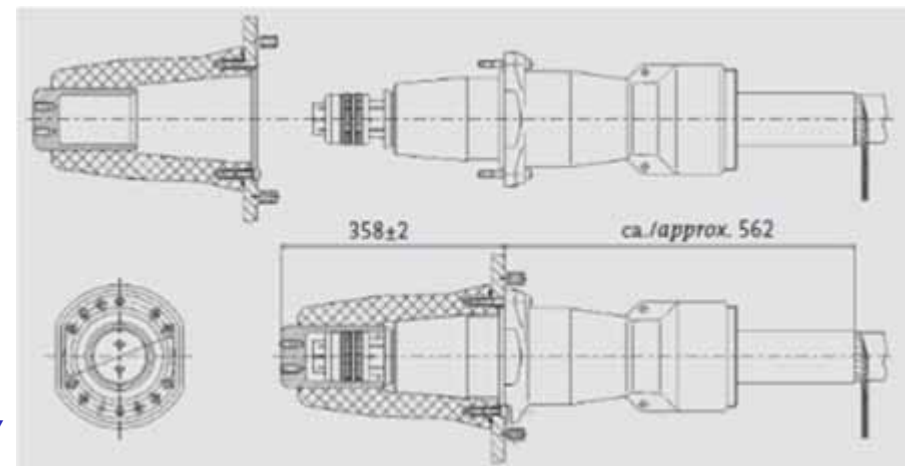

Plug-in cable termination – 72 kV

HV interfaces

HV cable connection

3/5
1/2

- Cable test requirements

- AC tests only need to open the cable disconnecter
- DC tests (obsolete) require to disconnect the cable from the GIS
- Cable test bushing shall be supplied by cable manufacturer

- Enclosure continuity

- Varistors shall be installed at GIS enclosure - cable sheath interface to provide smooth circuit to transients
- 6 varistors per phase are typical

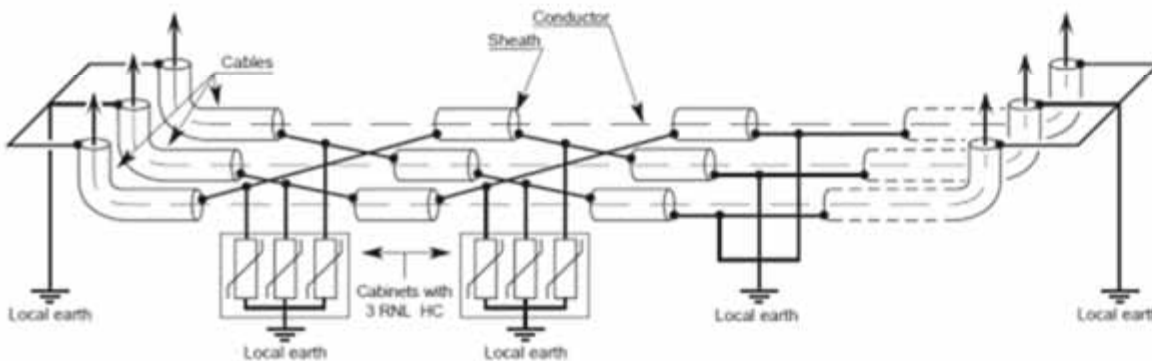

Electrical features

Reference	HC 1	HC 2	HC 3	HC 6
Rated voltage U_r (kV rms)	1	2	3.3	6
Continuous operating voltage U_c (kV rms)	0.8	1.6	2.7	4.8
Nominal discharge current I_n (kA 8/20)	10	10	10	10
High current impulse withstand (kA 4/10)	65	65	65	65
Long duration current withstand (A 2000 μ s)	150	150	150	150
Maximum residual voltage at 10 kA 8/20 = protective level (kV peak)	3	6	10	18

HV interfaces

Direct transformer connection

4/5
1/1

- IEC 61639 – 1996
- GIS test requirement



Direct transformer connection with adjustment bellow



Direct transformer connection with gas-insulated surge arrester at foreground

HV interfaces

Main busbars

5/5
1/1

- Recently issued standard

- IEEE C37.122.6: IEEE Recommended Practice for the Interface of New Gas-Insulated Equipment in Existing Gas-Insulated Substations Rated above 52 kV

- Main issues to decide

- Dimensions
- Materials
- SF6 density
- Mechanical loads
 - Thermal expansion
 - Earthquake withstand
- HV tests
- Who is responsible?

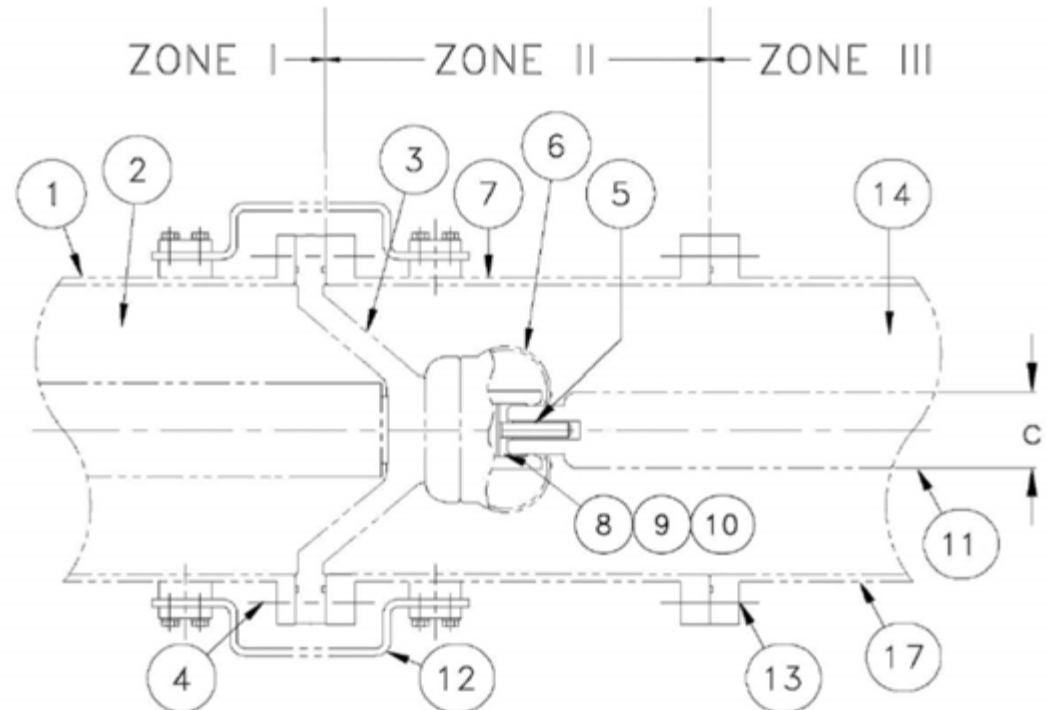

LV interfaces

1/1

- Local control cubicle types / location

- Stand-alone
 - Along the opposite wall
 - Close-by GIS bay
- Integrated in GIS bay

- Protection relays

- Can be integrated in LCCs

Australia – Barrow Island – 145 kV



Canada – Jackpine – Protection relays in integrated LCCs

GIS elements

Typical bay overview

1/18
1/1

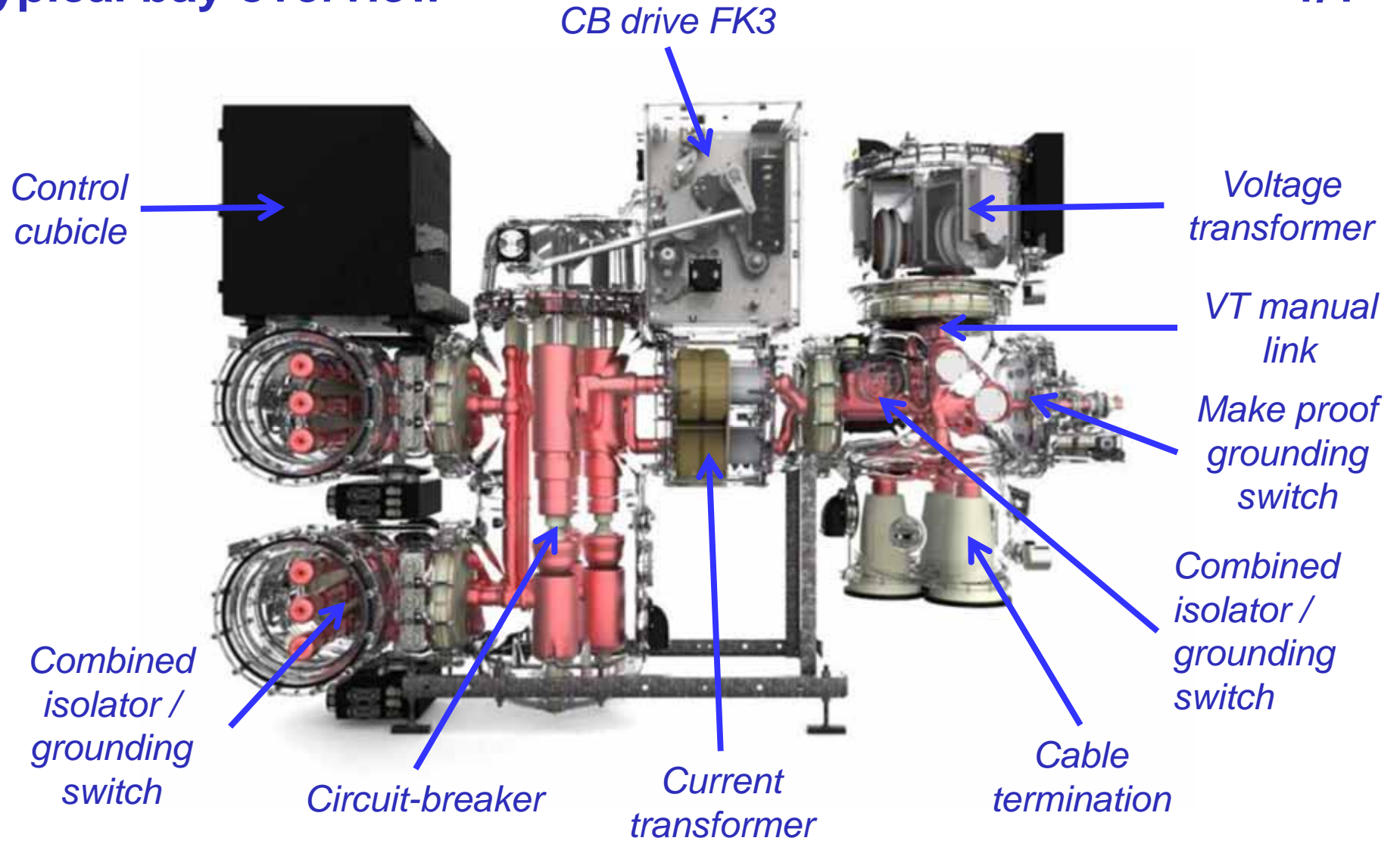

GIS elements Enclosures

2/18
1/1

- Aluminium alloy
 - No corrosion
 - Low resistance to return current
 - No eddy current losses
 - Lower weight
 - Industrial castings, except straight extruded / welded tubes



GIS elements

Conductors

3/18
1/1

- Aluminium alloy material, most often
 - For light weight
 - For mechanical properties
 - Silver-plating for sliding contacts

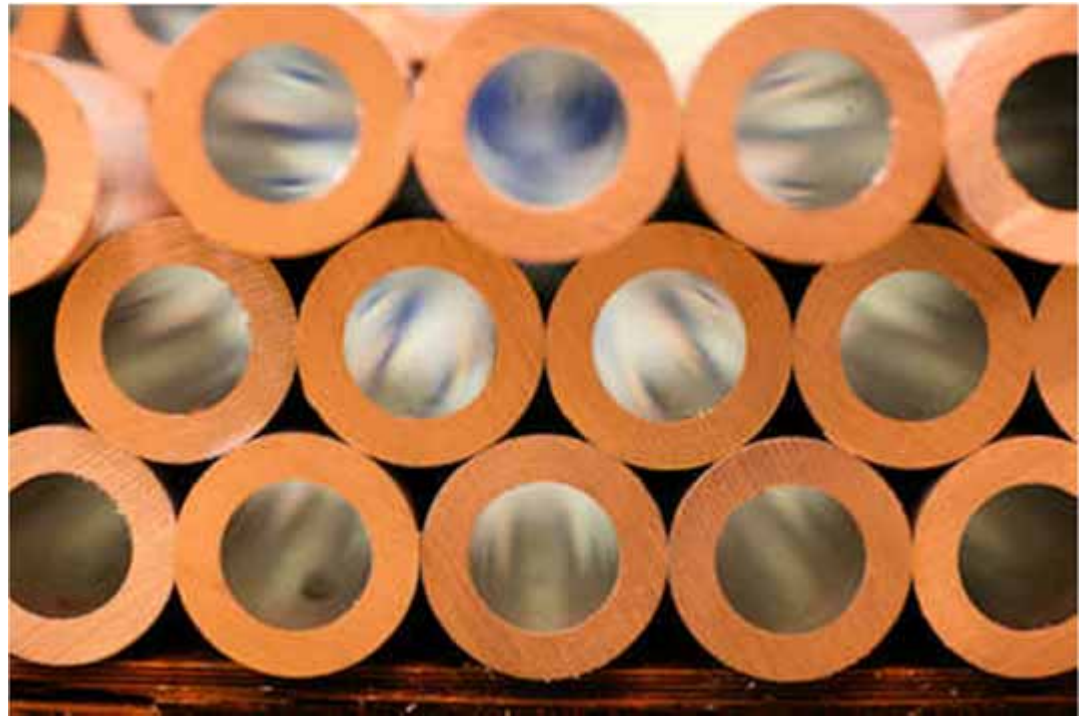

GIS elements

SF6 sealing

4/18
1/1

- Sealing design requirements
 - Tightness (<0.5 % per year)
 - Lifetime (50 years)
 - Avoid under-gasket corrosion
- Gasket material is essential
 - No electrolytic corrosion
 - Lifetime
 - Tight across the temperature range
 - Tight dynamic sealing
- Sealing manufacture requires utmost care
 - Prevent leakages
 - Avoid scratches, hair, etc.

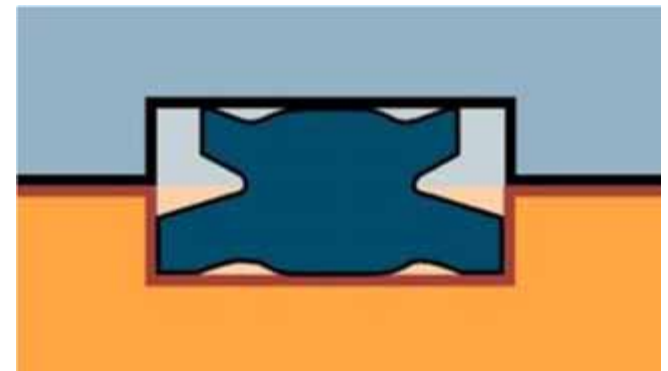
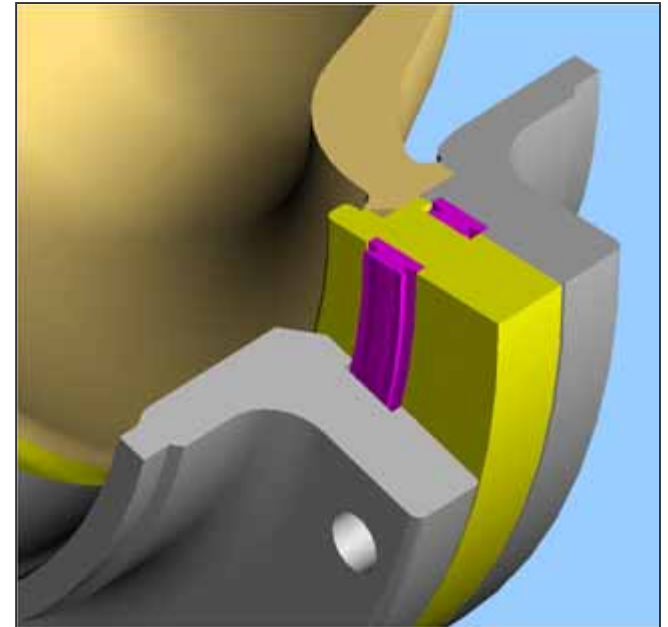

GIS elements

Insulators

5/18
1/1

- Insulators
 - Gas barriers
 - Support insulators

*3-phase
gas barrier*



Gas barrier



Support insulator



GIS elements

SF6 accessories

6/18
1/2

- Each GIS compartment shall be associated with one set of accessories
 - Density sensor
 - Pressure switch, temperature-compensated with/without gauge
 - Analogue / digital sensor, for continuous monitoring
 - Most important is to ensure sensors are at same temperature as enclosures
 - Avoid pipes (circulating currents threats, too)
 - SF6 valve
 - Valves can be no return / tap
 - Section shall be high enough to enable appropriate vacuum (< 1 mbar) within a reasonable time



GIS elements

SF6 accessories

7/18
2/2

- Each GIS compartment shall be associated with one set of accessories (cont'd)
 - Moisture adsorber = Molecular sieve
 - Adsorption surface: 20 to 800 sq.m/g
 - Adsorption ratio; 10~20 %, by mass
 - Pressure relief
 - Section shall be such that pressure does not go beyond the enclosure limit pressure
 - Heat-resistant deflectors shall protect personal in case of internal flashover

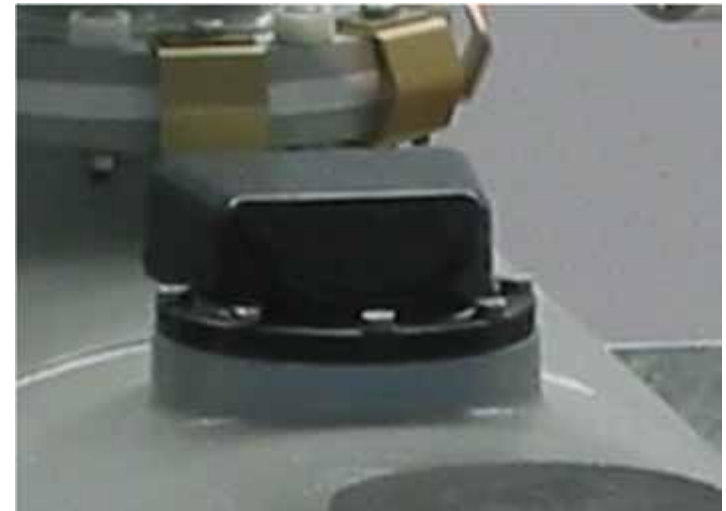

GIS elements

Circuit-breaker

8/18
1/1

- Main substation item
- Grading capacitors in case of several breaks per pole
- Tested at 10,000 Close/Open cycles



GIS elements

Circuit-breaker drive

9/18
1/2

- Different types
 - Spring drives, with no driving fluid
 - Recognized by CIGRE report as more reliable
 - Hydraulic drives
 - Gas storage
 - Spring storage
 - Pneumatic drives
 - Out-dated
 - Need of water draining



GIS elements

Circuit-breaker drive

10/18
2/2

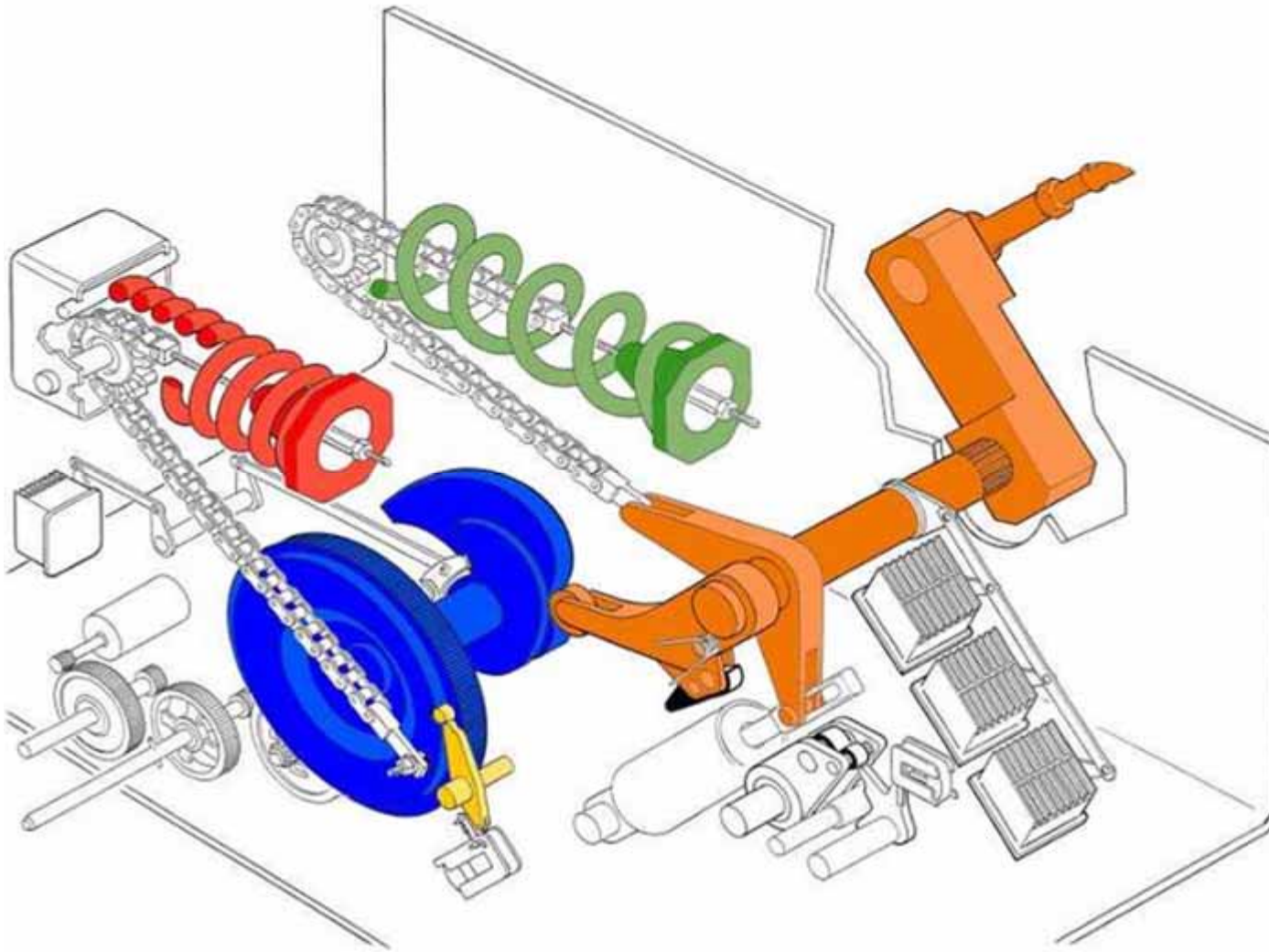

- No move when CB is not operated, while hydraulic and pneumatic mechanisms daily require several pump starts for pressure topping-up
- Stable timing, insensitiveness to temperature and pressure, ideal for POW switching.

GIS elements

Disconnecter (isolator)

11/18
1/1

- Does not break any other current than
 - Capacitive current of short lengths of GIS: $< 0.1\sim 0.5$ A
 - Transfer current of double BB substations: 1600 A @ 10~40 V
- Can be associated with a grounding switch

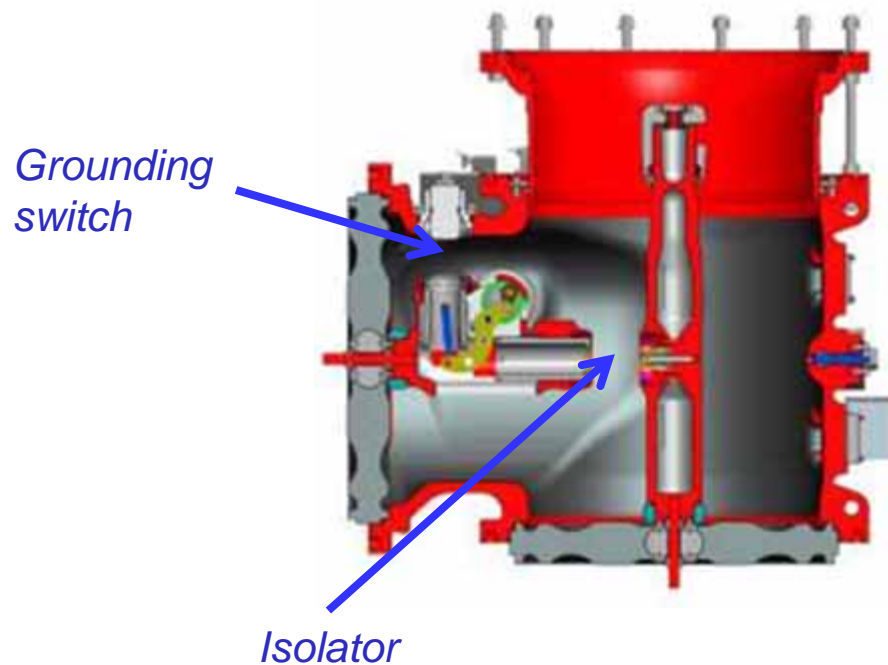

GIS elements

Earthing (grounding) switch

12/18
1/2

- Speed
 - Low speed, sometimes combined with an isolator
 - High-speed, with short-circuit making capability
- Interrupting capability
 - Inductive coupling current, when both ends of a parallel OHL are grounded
 - Capacitive coupling current, when one end of a parallel OHL is grounded

Rated voltage U_r kV	Electromagnetic coupling				Electrostatic coupling			
	Rated induced current A (r.m.s.)		Rated induced voltage kV (r.m.s.)		Rated induced current A (r.m.s.)		Rated induced voltage kV (r.m.s.)	
	Class		Class		Class		Class	
	A	B	A	B	A	B	A	B
52	50	80	0,5	2	0,4	2	3	6
72,5	50	80	0,5	2	0,4	2	3	6
100	50	80	0,5	2	0,4	2	3	6
123	50	80	0,5	2	0,4	2	3	6
145	50	80	1	2	0,4	2	3	6

GIS elements

Earthing (grounding) switch

13/18
2/2

- Insulation

- Grounding switch is normally connected to the ground
- Can be insulated for tests
 - Contact resistance
 - CB timing
 - CT primary injection
- Safety issue
 - Never disconnect a GS from ground when 0 voltage is not ascertained

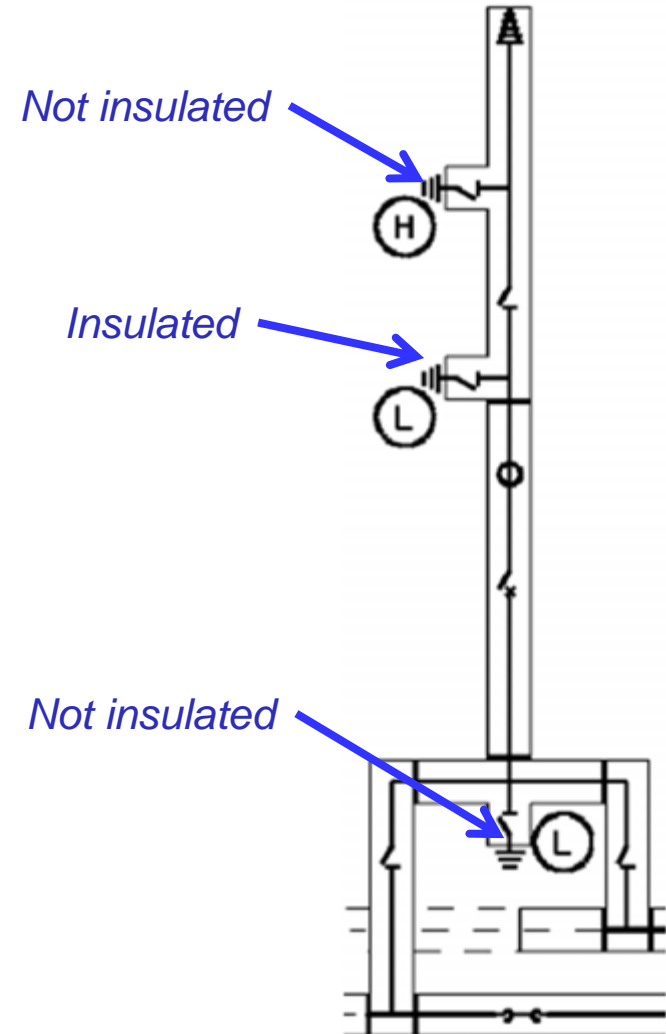

- Isolator: check full-open position
=> ascertain voltage withstand
- Grounding switch: check full-close position
=> ascertain capability to carry full short-circuit current
- Large viewports (approx. 2-3 inches diameter)
 - Can be used to both lighten and view
- Small viewports (less than 1 inch diameter)
 - Two viewports are required, one for lighting, second for viewing
- Viewport access
 - When access is too difficult, one shall use either a mirror device (arm's length), or a video camera



GIS elements

Current transformer

15/18
1/1

- Ratings
 - Power
 - Quite often over-specified
 - Accuracy
 - Safety factor
 - No more an issue with modern measuring units
 - Saturation
 - To be carefully engineered
- Low ratios
 - Difficult to achieve with a single primary turn
- Overvoltage protection
 - Specific design to implement inside GIS



GIS elements

Voltage transformer

16/18
1/1

- Ratings
 - Power
 - Quite often over-specified
 - Accuracy
- Ferro-resonance
 - Mainly in case of CB grading capacitors
 - Can be avoided using a special inductance
 - Requires a specific study



GIS elements

Surge arrester

17/18
1/1

- Overhead line connections
 - Generally air-insulated
 - Sometimes gas-insulated
- Cable connection / direct transformer connection

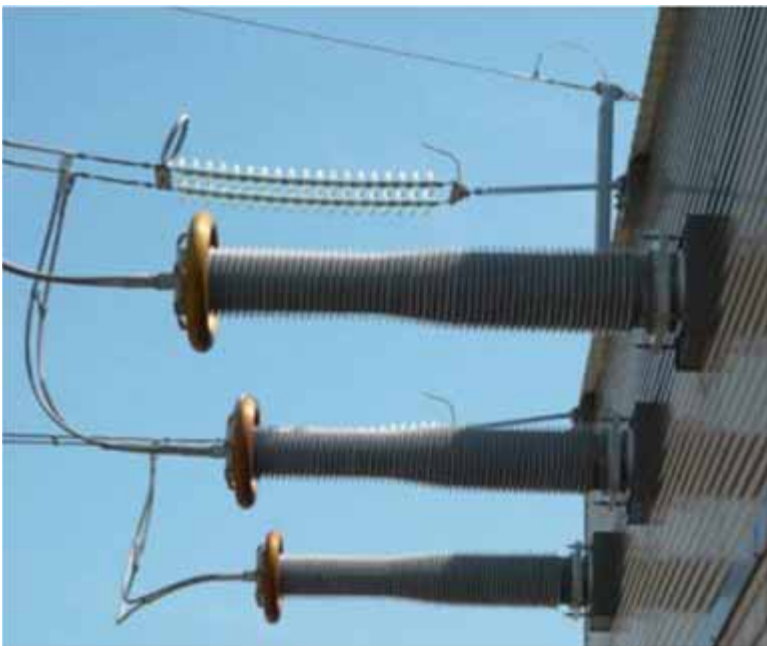

GIS elements

Gas-insulated line / bus

18/18
1/1



Monitoring Intro

1/6

1/1

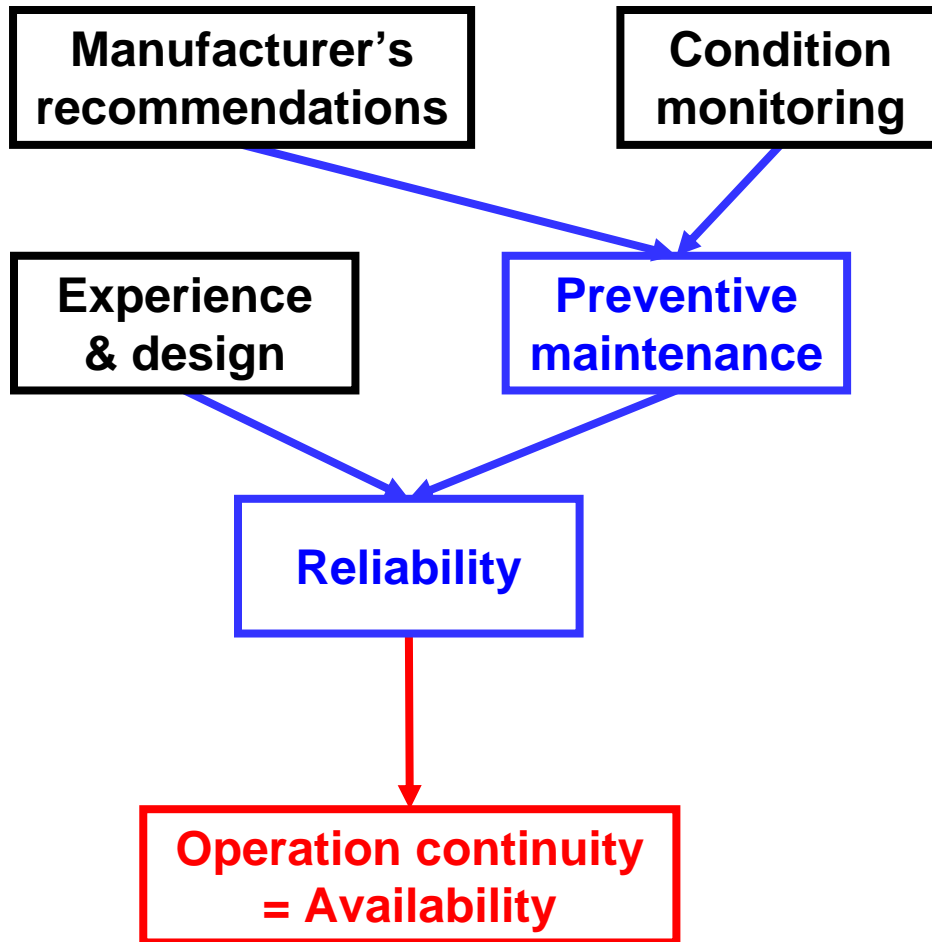

- Condition monitoring is an important driver of preventive maintenance, reliability and availability
- “better prevent than cure” concept

Monitoring SF6

2/6
1/1

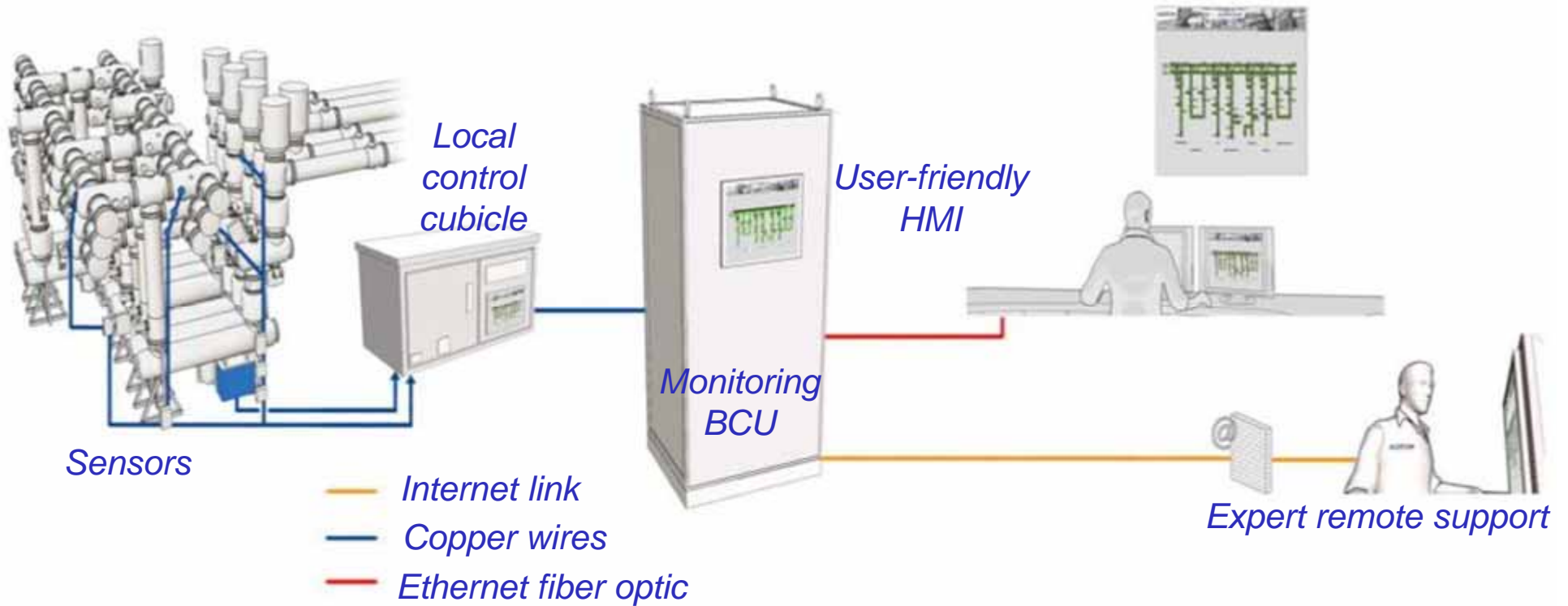

BWatch sensor

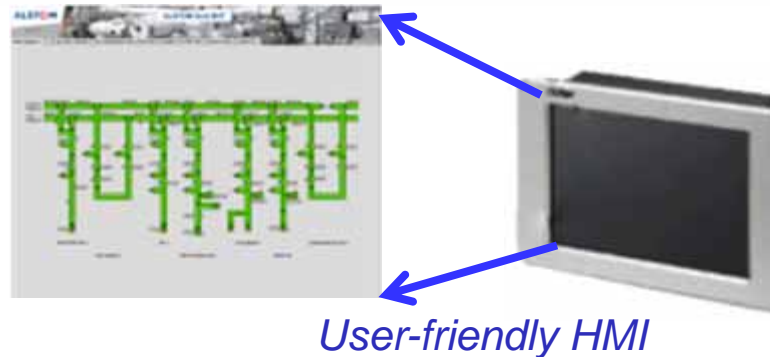

User-friendly HMI

Monitoring

Circuit-breaker, isolator, grounding switch

3/6
1/1

- CB
 - Travel curve
 - Need of a sensor
 - Contact wear
 - $\Sigma I^2 * t$
- Isolator / grounding switch
 - Operating time
 - Motor inrush current

Monitoring Partial discharges / UHF

4/6
1/3

- More than 50% of defects have a dielectric origin
- Defects trigger partial discharge (PD) activity before any flashover
- PD trigger ultra-high frequency (UHF) radio waves
- Partial discharges cannot be easily and continuously monitored
- UHF signals are thus monitored, using capacitive couplers (antennas / UHF sensors)

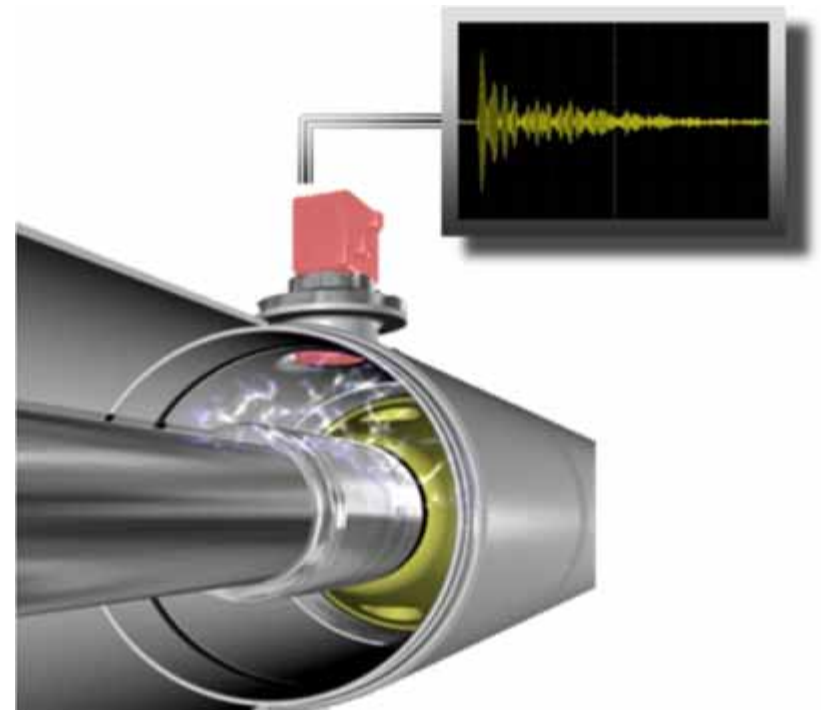

Monitoring Partial discharges / UHF

5/6
2/3

- EM waves are broadcast from 300 MHz up to 20 GHz
- UHF monitoring is applied to frequencies ranging from 300 MHz to 1,2 GHz
- Sensor location is essential
 - GIS manufacturer experience is a must

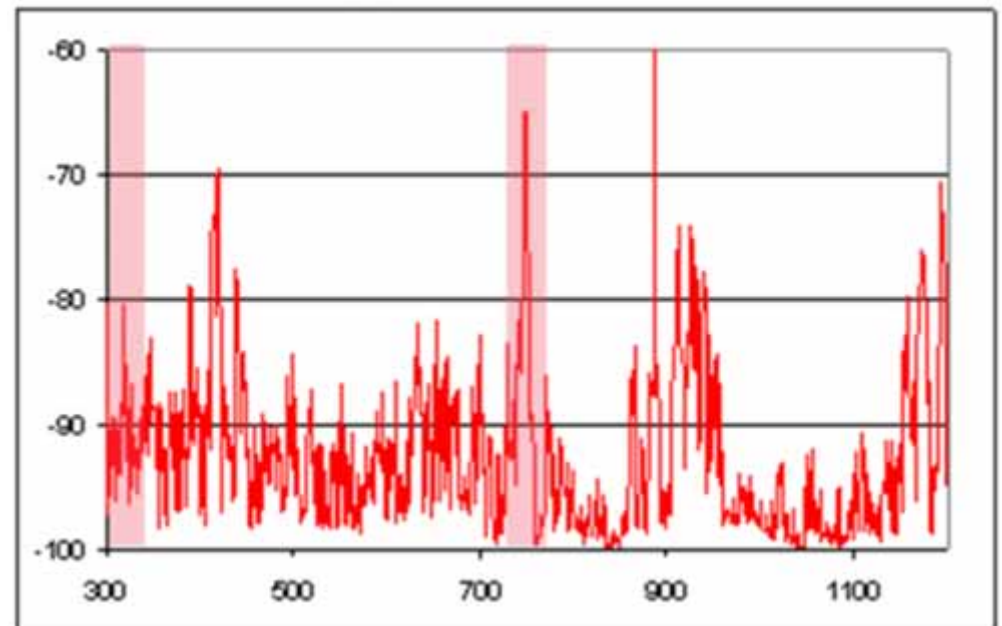

Monitoring Partial discharges / UHF

6/6
3/3

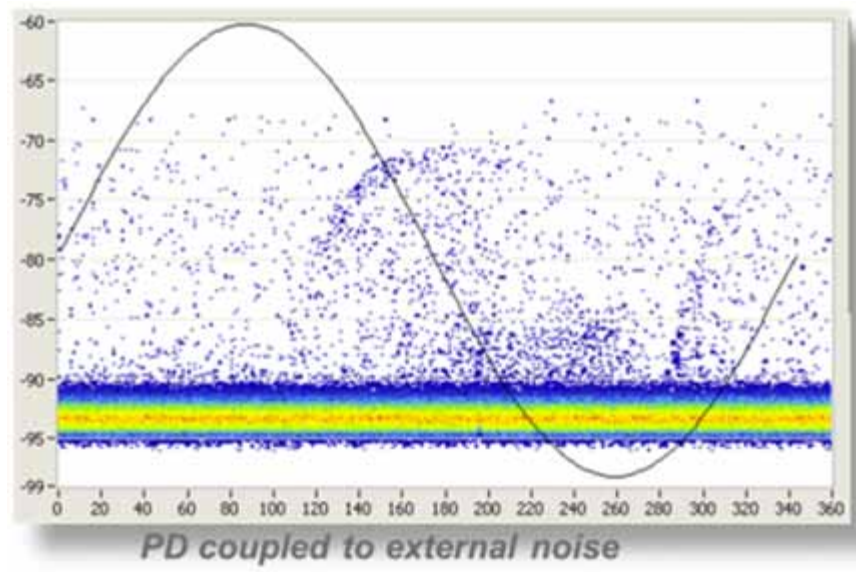

- Electromagnetic noises can
 - hide typical PD signal
 - be interpreted as PD signal
- Signal pattern analysis => defect type
- Expert system helps in making decision

Light noise

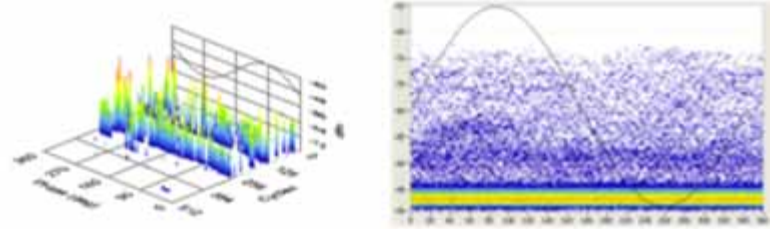

Corona noise

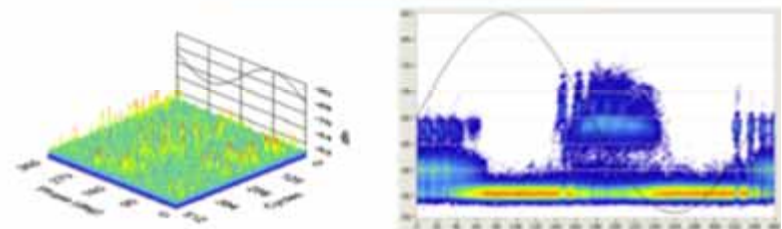

Cell phone

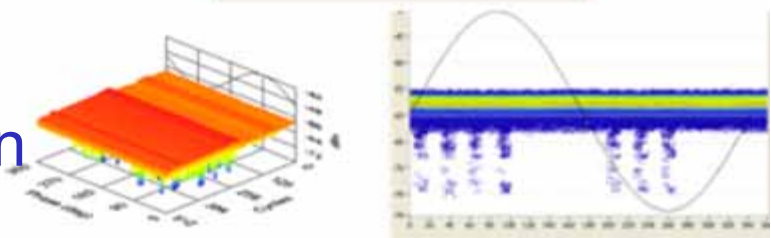

Point-on-wave switching

Intro

1/9
1/1

- Individual CB pole switching @ **the appropriate time**
- 2014 Singapore GIS Users Group features a conference on POW switching

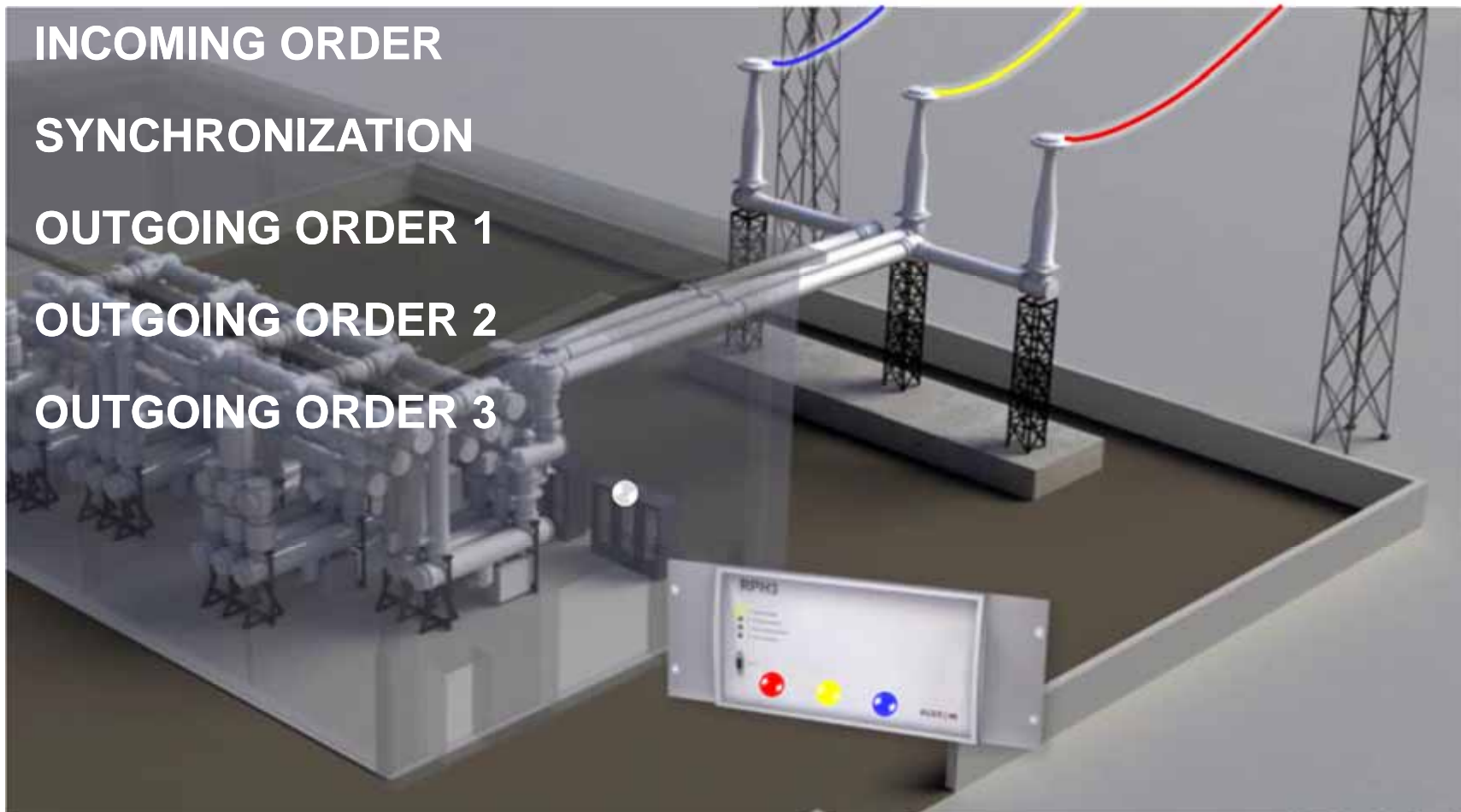

Point-on-wave switching

Overhead lines

2/9
1/3

- Existing techniques to mitigate switching overvoltages impact
 - Closing resistors
 - Surge arresters
 - At line terminals, at some intermediate points
 - Point-on-wave (POW) switching
 - And/or combination of above means
- Additional requirements
 - Compensated overhead lines
 - Entails “beat waves”

Point-on-wave switching Overhead lines

3/9
2/3

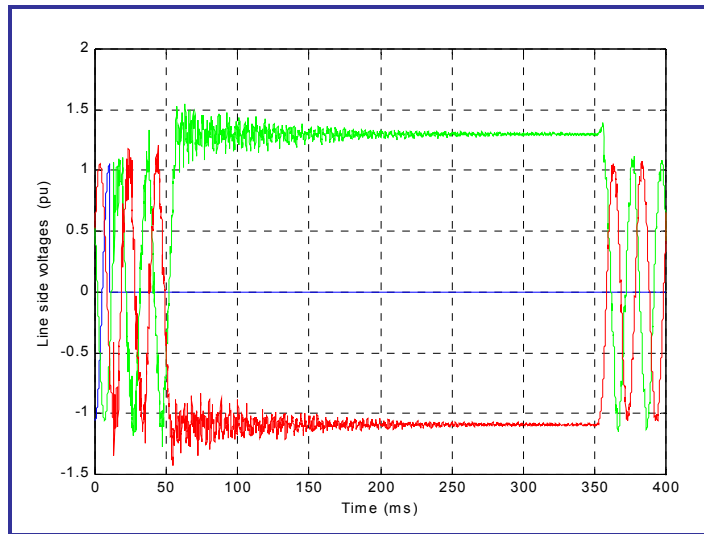
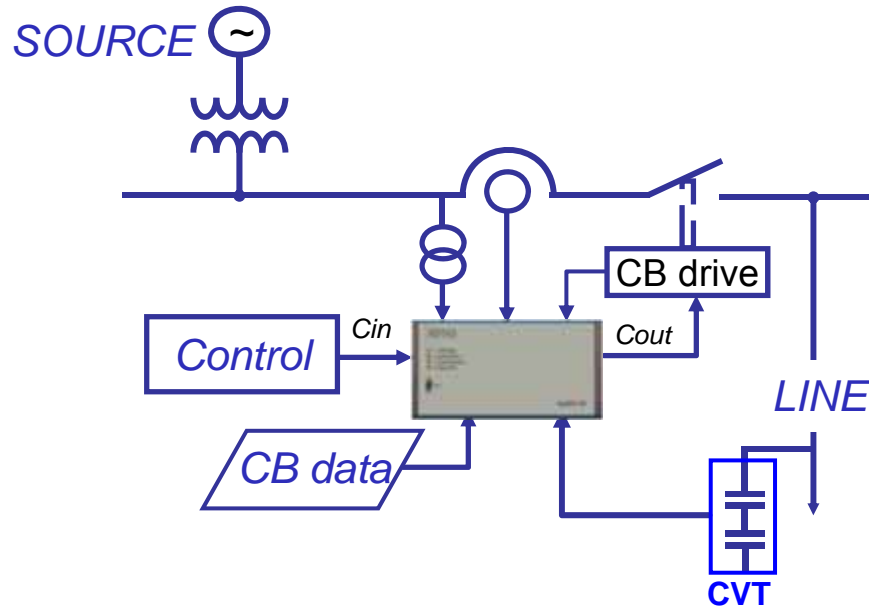

- Non-compensated line with capacitive VT
 - Faulted phase
 - Line is discharged by the fault
 - Reclosing at ZERO source-voltage
 - Healthy phase
 - Line has kept DC trapped charge
 - Reclosing at PEAK source-voltage with same polarity as DC trapped charge

Point-on-wave switching Overhead lines

4/9
3/3

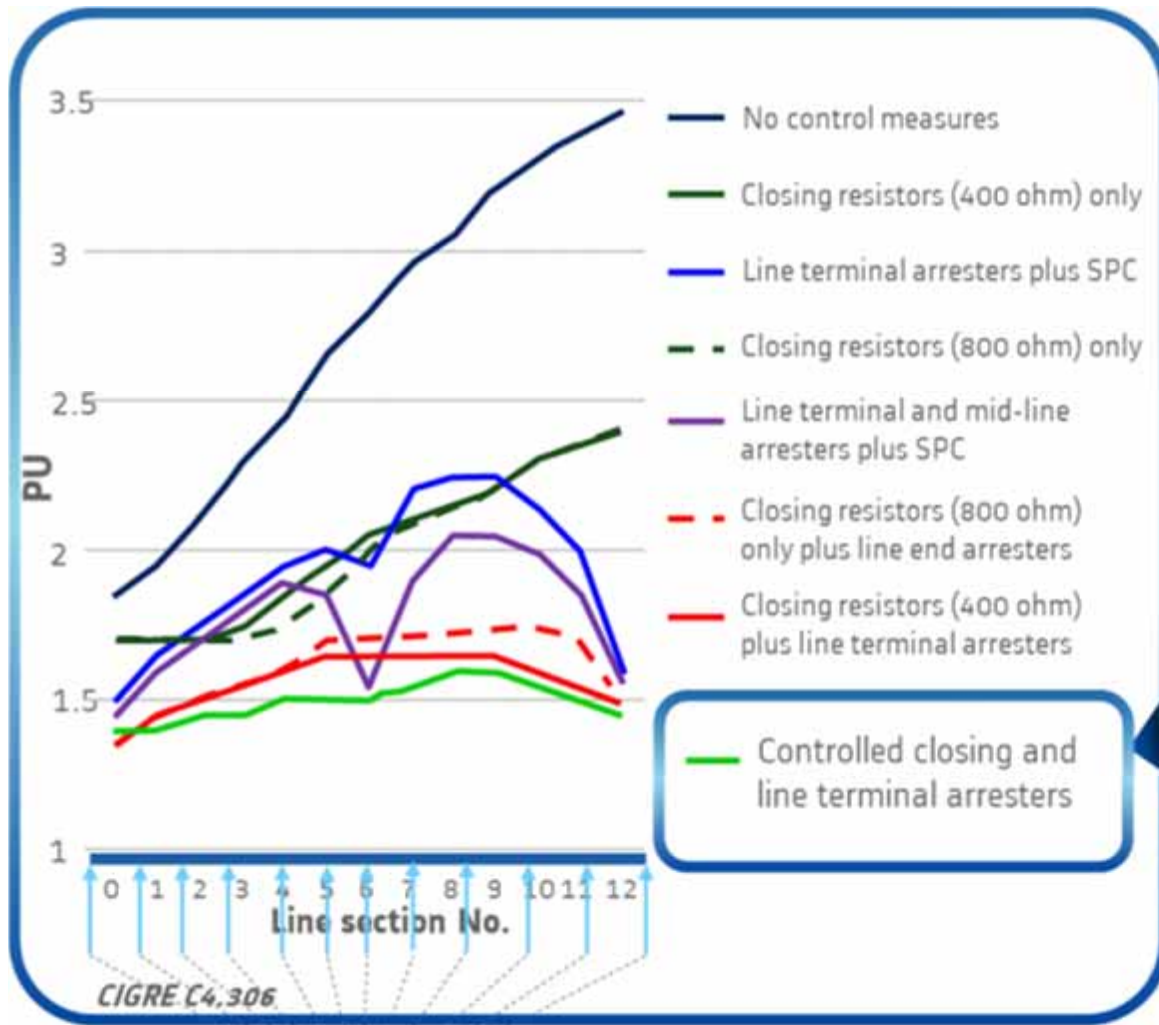

VOLTAGE MEASUREMENT POINT

Point-on-wave switching

No-load transformer switching

5/9
1/3

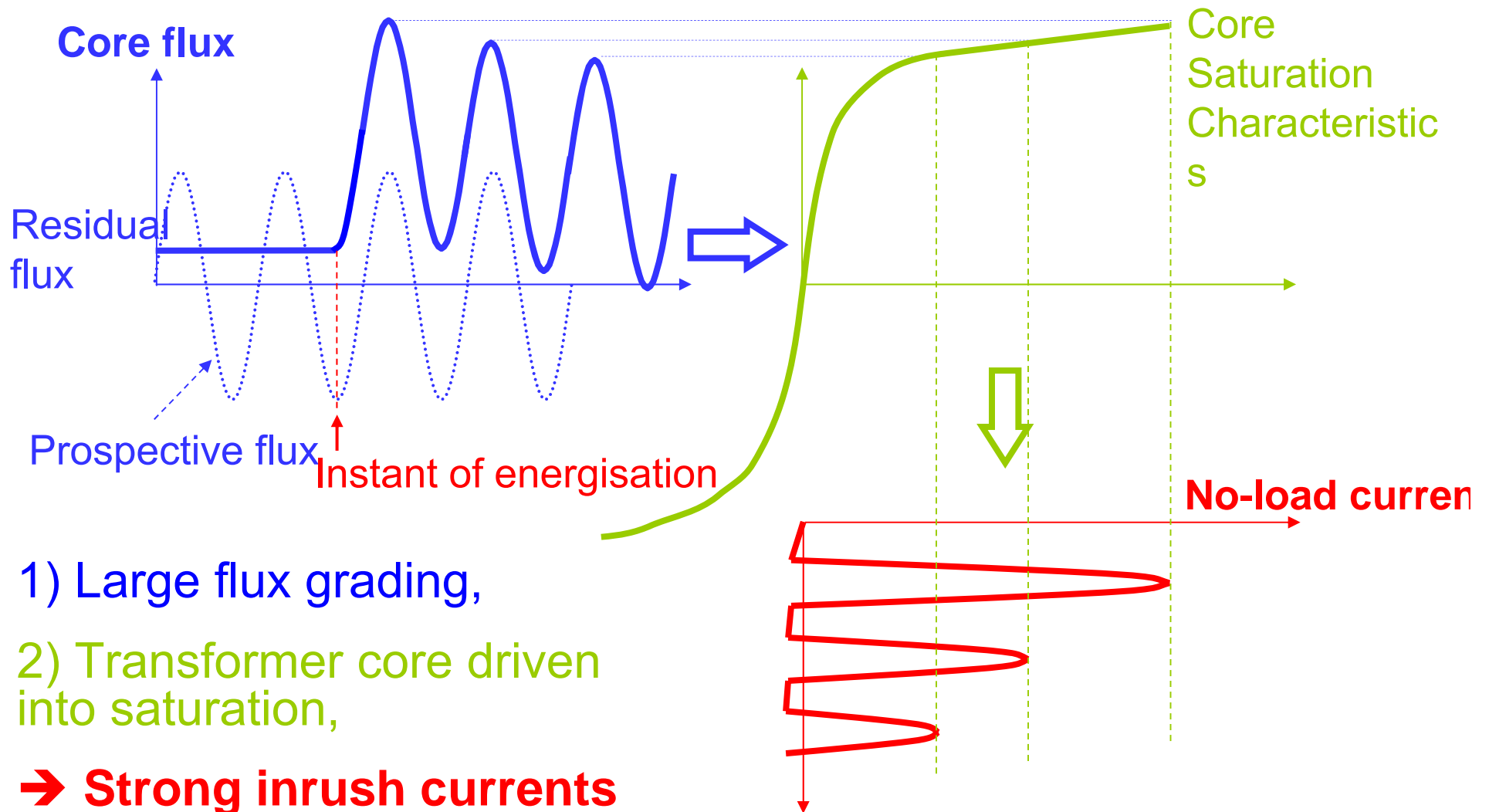

Point-on-wave switching

No-load transformer switching

6/9
2/3

- Random closing following random opening
- Inrush current peak value = 4500 A

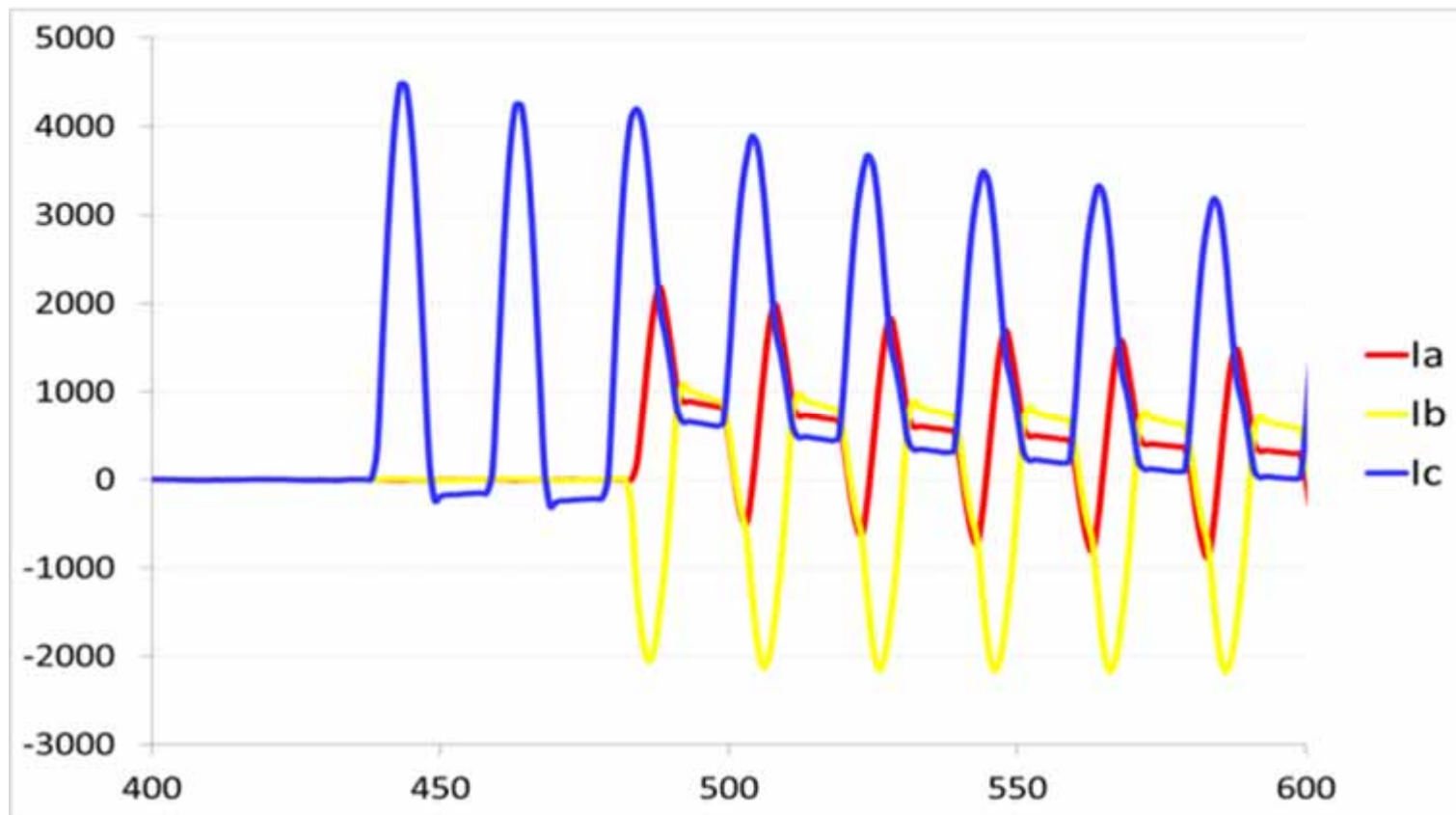

Point-on-wave switching

No-load transformer switching

7/9

3/3

- Controlled closing subsequent to controlled opening
- Inrush current peak value = 500 A

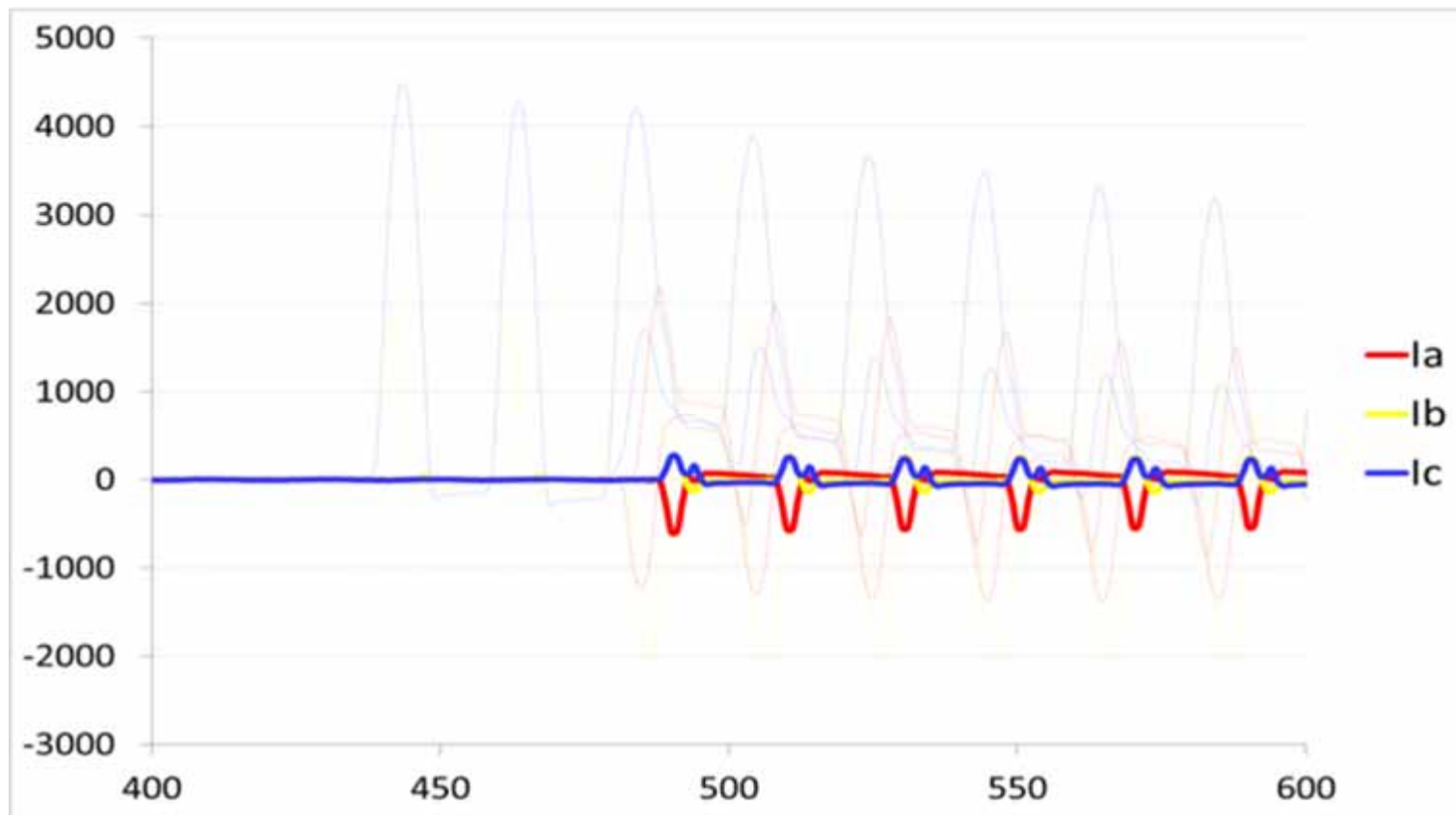

Point-on-wave switching Reactor switching

8/9
1/1

- Main issue: Current re-ignition during breaking
- POW will trigger opening in order to avoid short arcing times

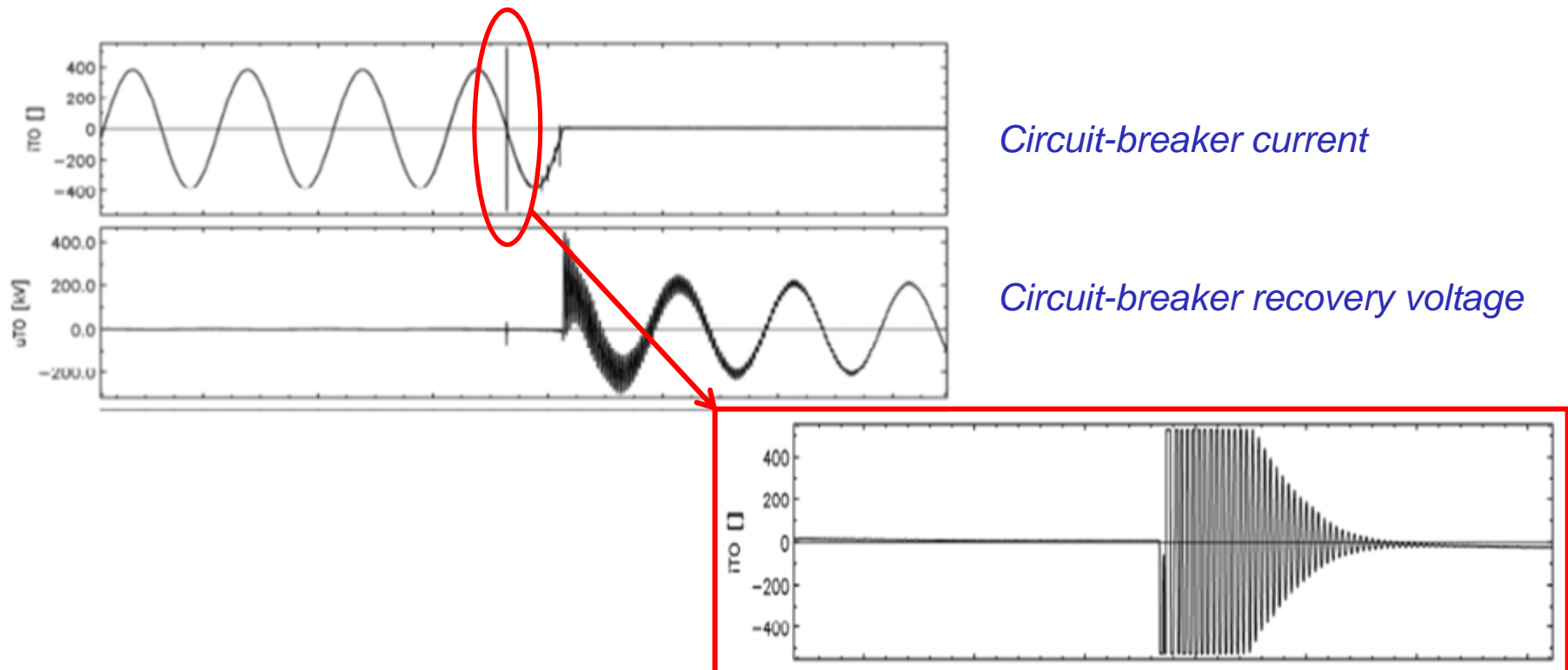

Point-on-wave switching

Capacitor bank switching

9/9
1/1

- Parallel capacitor banks switching entail high inrush currents and overvoltages
- Such phenomena occur upon making (switching-on)
- POW will trigger the closing order in order to make the current when voltage across CB is zero (\Leftrightarrow busbar voltage is zero)
- Such issue is detailed in IEC and IEEE stds
- Long cables can benefit from same technology

Project execution process

RFQ process

1/3
1/1

- RFQ specification
 - Has to specify the functions / features / ratings to achieve
 - Has to let free the ways to get these achievements

Project execution process

Site installation

2/3
1/1



- Supervision of installation by a specialist of the GIS manufacturer is a must for the warranty coming-into-force



Project execution process

Energizing

3/3
1/1

- As far as possible, in order to anticipate a failure (despite the HV tests), energizing shall be made in such a way that a failure would trigger a low short-circuit current
- To achieve the above
 - Length of the supply lines/cables shall be extended as much as possible
 - A low power transformer shall be used to supply the energizing voltage

Protection & Control

1/1

Double busbar SLD - the GIS “anomaly”

1/1

- In case of a failure inside an open BB isolator, both busbars will be tripped (same as in case of a coupler CB failure)
- Fast operation restore requires to shortly find out the faulty disconnecter
- Internal failure localisation system is appropriate to ascertain such a short localisation
- SF6 continuous monitoring can be fitted with appropriate features to provide this function

The “digital substation” IEC 61850

2/8
1/1

- A crucial technology enabler
 - Enables full digitalizing of substation signals, so that large data amounts can be managed and communicated for the real-time management of a modern power grid – a smarter grid.



The “digital substation” Architecture

3/8
1/1

The digital substation architecture can be divided into three levels

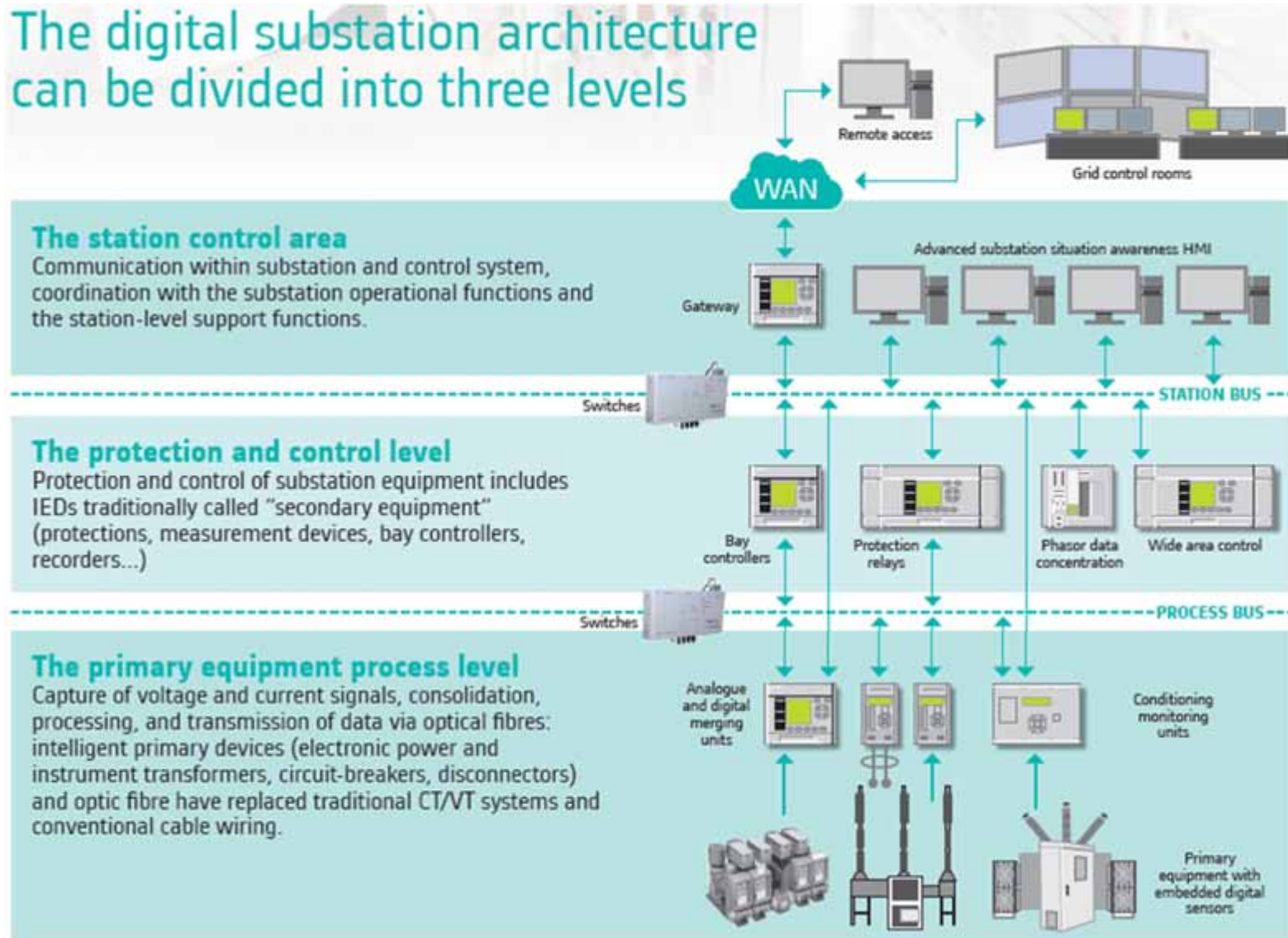

The “digital substation” Measuring

4/8
1/1

- Rogowski sensors dispense with the conventional CT core and instead implement windings as tracks on a multi-layer printed circuit board. The sensor output is a low level voltage, which is accurately correlated to the primary current.
- Capacitive dividers dispense with the conventional VT. Capacitors are built from special electrodes laid inside the enclosure.



The “digital substation” Conversion

5/8
1/1

Converters

Alstom Grid digital substations optimise the amount of electronics residing in potentially harsh outdoor environments.

The primary converters convert analog signals from the primary equipment into digital signals. Primary converters can be installed either directly in primary plant hardware or in cubicles.

Digital controllers (switch control units) are the fast, real-time interface to switchgear, mounted close to the plant which they command. They replace the hardwiring of inputs and outputs with an Ethernet interface to the yard.



Primary converter

Merging units

Merging units perform all the digital data processing necessary to produce a precise, time-aligned output data stream of sampled values according to the IEC 61850-9-2 standard. This processing includes tasks such as sampling, analog to digital conversion, scaling, precise real-time referencing and message formatting.

The design may vary with the applied technology of the instrument transformers (eg: optical, Rogowski, voltage dividers, or conventional wound instrument transformers), the switchgear type, mounting space available and also with the preferred substation communication architecture.



The “digital substation” Protection

6/8
1/1

• Customer benefits

- Proven algorithms of conventional applications remain unchanged, no need for reapprove
- Time-critical performance is maintained irrespective of the architecture, number of functions enabled, or extent of logic programmed
- Safer test and maintenance operations – no wired CT
- Accurate measurement capabilities
- Station bus communication redundancy available: PRP (Parallel Redundancy Protocol) and RSTP (Rapid Spanning Tree Protocol)



The “digital substation”

Control and monitoring

7/8
1/1

- Issues to be managed
 - Substation automation
 - Redundant architectures
 - Substation/grid control room communications
 - Cyber security



The “digital substation” Asset Health Management

8/8
1/1

- With less wiring and fewer commissioning tests, asset management is grounded on a set of tools that optimize preventive maintenance and extend lifetime
 - Maximize the substation availability
 - Operate assets, more efficiently and safely
 - Optimize maintenance, repair and retrofit, with minimum outages



Alstom Grid team in US

- Clarence Wallace Area Sales Manager
clarence.wallace@alstom.com +1 281 744 2662
- Pablo Gonzalez GIS Sales Specialist USA
pablo.gonzalez@alstom.com +1 484 497 1037
- Paul Benoit Unit Commercial Director, SYS
paul.benoit@alstom.com +1 3012660777
- David C Rains Director Oil & Gas NAM Region
david.c.rains@alstom.com +1 832 757 5491

Speaker

- Jean-Louis Habert GIS PL Marketing Director
 jean-louis.habert@alstom.com +33 479 887 940

Your questions and comments are welcome !

