



WIRE REINFORCEMENT INSTITUTE®

TECH FACTS

Excellence Set in Concrete®

942 Main Street • Suite 300 • Hartford, CT 06103 (800) 552-4WRI [4974]

DESIGN OF SLAB-ON-GROUND FOUNDATIONS

A Design, Construction & Inspection Aid For Consulting Engineers

August 1981

Prepared for:

Copyright, Wire Reinforcement Institute

Wire Reinforcement Institute

942 Main Street

Hartford, CT 06103

Phone (800) 552-4WRI [4974]

Fax (860) 808-3009

Authored By:

Walter L. Snowden, P.E.

2613 Passion Flower Pass

Cedar Park, TX 78613

Phone: 512-331-6159

Fax: 512-331-6002

Email: wlspe@sbcglobal.net

This procedure was developed by Walter L. Snowden, P. E., Consulting Engineer, of Austin, Texas, over a period of some 15 years. It is empirically derived by observing slab performance and writing or modifying equations to give results which approximate the foundations which had been found to give satisfactory results.

In addition, Mr. Snowden, has served on the Pre-Stress Concrete Institute Ad Hoc Committee for the development of "Tentative Recommendations for Pre-Stressed Slabs-on-Ground" and as a Consultant to the Building Research Advisory Board Committee on Residential Slabs-On-Ground.

Designs done by this method should be economical yet give quite satisfactory results with a minimum of deflection and resulting superstructure distress.

While this publication deals only with foundations reinforced with reinforcing bars and/or welded wire reinforcement, the procedure has been developed to be independent of the type of reinforcing used.

Table of Contents

INTRODUCTION	1
EARLY DEVELOPMENTS	1
SOILS INVESTIGATIONS	2
LABORATORY TESTING	3
DETERMINING THE EFFECTIVE P.I.	5
OTHER PARAMETERS	5
WARNING	6
LOADING CONSIDERATIONS	7
SUPPORT CONSIDERATIONS	7
THE SLAB DESIGN	10
BEAM SPACING AND LOCATION	12
SLAB REINFORCING	13
BEAM REINFORCING	13
SITE PREPARATION	14
SLAB FORMING	15
STEEL PLACEMENT	16
SPECIAL CONDITIONS	19
CONCRETE PLACING	20
INSPECTION	22
SHRINKAGE CRACKS	23
APPENDIX A NOTATION	
APPENDIX B DESIGN EXAMPLES	
APPENDIX C REFERENCES	

INTRODUCTION

Within the last several years there has been a lot of interest in a design procedure for the design of light foundations, particularly for use under single family residences. Reports and recommendations have been undertaken and prepared by several study groups for the purposes of developing design criteria or extending the Criteria for Selection and Design of Residential Slabs-on-Ground, BRAB Report #33. The recommendations derived from these and other studies vary from extremely light to extremely heavy.

It was actually the widespread use of the “post-tensioned” slab-on-ground which induced this interest in design procedure and in many studies of reported slab failures. Such reports have; perhaps, created an over-cautious climate concerning any moves to lighten the design requirements set forth in BRAB Report #33. Many theoretical analyses show that no lessening of the requirements is possible, while other studies and actual field installation indicate that considerable variances are permissible in many areas.

In the design procedure to be presented herein, adjustments are made to the BRAB procedure which allow the use of this simple procedure with larger slabs and further simplify the design engineer’s problem of designing an adequate foundation at a reasonable cost, both in terms of the engineer’s time, and cost of the installation itself.

The intent of this handbook is to provide a design procedure which could be used in any Consulting engineer’s office to give adequate designs for economical construction without the use of large computers, or the necessity for site investigations so extensive as to make the use of engineered foundations economically prohibitive. The following pro-

cedure, with modifications, has been used for the last 15 years in designing foundations in the southwest with excellent results.

EARLY DEVELOPMENTS

In the early 1950’s the use of the monolithic reinforced slab foundation became widespread in the south central portion of the United States. For the most part there were no consistent standards, and many different versions of this foundation were to be found throughout the area. Each office of the Federal Housing Administration had a different version being used in its area, and the differences in cross-section and reinforcing were great. Engineers did not have a generally accepted procedure to analyze the slab, and, therefore, the problem was mostly ignored.

In 1955 the Federal Housing Administration together with the National Academy of Science organized a group of nationally eminent authorities and began a several year research project to develop guidelines for design of slab-on-ground foundations.

The final report, Building Research Advisory Board (BRAB) Report #33 entitled Criteria for Selection and Design of Residential slab-on-ground, was issued in 1968 and was widely discussed by builders. First designs to follow the BRAB Report required foundations heavier even than the San Antonio FHA office standard LAS-22 (Fig. 1). LAS-22 was thought to be the heaviest design ever needed, but a local study showed it was inadequate perhaps 30% of the time. There was naturally, great resistance to the added costs of design and construction required by the BRAB Report.

The next important contribution also occurred in 1968 when a full scale post-tensioned slab was built and tested to destruction. A subsequent report established the feasibility of using post-tensioning in slab-on-ground construction and verified many of the BRAB assumptions.

In 1965 the writer developed a complete, overall design system, later modified to conform, in format, to BRAB Report #33 and further influenced by the work done by H. Platt Thompson, P.E. This system gained wide use in both Austin and San Antonio because of the lower cost which the post-tensioned

slab enjoyed compared to the heavier F.H.A. San Antonio "Standard Slab".

Variations from the BRAB Report #33 were developed to maintain a reasonable ratio between cost of the slab-on-ground and the value of the house it supported. The variations presented later in this paper have been derived empirically.

SOIL INVESTIGATIONS

It is considered imperative that a soils investigation be made on any site on which a design is to be prepared.

RESIDENTIAL SLAB-ON-GROUND CONSTRUCTION FEDERAL HOUSING ADMINISTRATION SAN ANTONIO~ TEXAS INSURING OFFICE

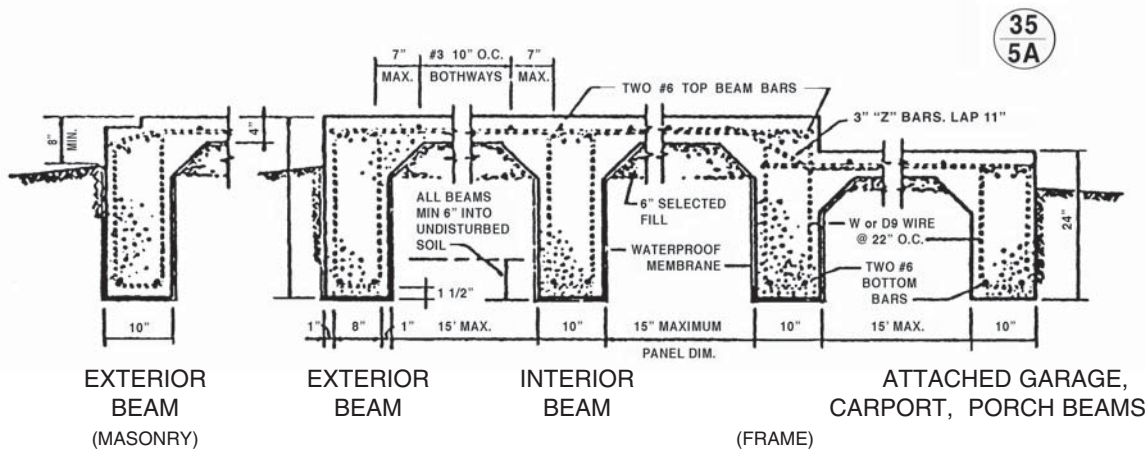

ALL RESIDENTIAL SLAB-ON-GROUND CONSTRUCTION SHALL COMPLY WITH THESE MINIMUMS. VARIATIONS ARE ACCEPTABLE WHERE SOIL INVESTIGATION OF THE BUILDING SITE, CLIMATIC RATINGS, AND ENGINEERING ANALYSIS INDICATE A SLAB OF LIGHTER OR HEAVIER DESIGN IS SUITABLE.

CONCRETE: 2500 PSI MIN. COMPRESSIVE STRENGTH. LAPS OR SPLICES: MINIMUM 30 DIAMETERS.

SLAB: 4" MINIMUM THICKNESS WITH W OR D9 WIRE 10" O.C. BOTH WAYS. MAXIMUM CLEAR PANEL BETWEEN BEAMS IS 15 FEET. BEAMS: 10" WIDE BY 30" DEEP. (24" DEEP FOR ATTACHED GARAGE. CARPORT, OR PORCH BEAMS) REINFORCE WITH TWO #6 BARS TOP AND TWO #6 BARS BOTTOM, CONTINUOUS. SPACE ALL STIRRUPS 22" O.C. ALL BEAMS SHALL PENETRATE MINIMUM 6" INTO UNDISTURBED SOIL.

CORNER BARS: PROVIDE #6 CORNER BARS IN ALL CORNERS OF THE PERIMETER OR EXTERIOR BEAMS. INSTALL ONE AT TOP, OUTSIDE. AND ONE AT BOTTOM, OUTSIDE.

FIGURE 1

For a small site with one structure, the minimum is obviously one test boring, which should be made where the worst soil condition is anticipated; ie, where fill is located, or where the worst clay is suspected. If it is not obvious, then more than one test hole is indicated. In no case should a design be attempted without an adequate soils investigation of the site.

For large sites with large structures or more than one structure, several test holes must be used. In planning the investigation, plan for the worst. It is always possible to omit borings in the field, based on data as it develops.

For a subdivision, there can be no fixed minimum number of borings. The work done should be that which is required to get the answer. In general, locating holes about one to every four or five lots, if the subdivision is reasonably uniform, will be adequate. Should different materials be encountered, additional borings must be placed to provide more complete information of the underlying soils. In some cases it is necessary to drill each lot. When a contact between a high P.I. soil and limestone is discovered, for instance, each lot which the contact crosses must be designed as though the entire lot were the worst soil condition.















As drilling progresses, samples should be taken at 2' intervals and at each different soil strata encountered, to a depth of at least 15'. If it is likely that some soil will be cut from the lot, borings should be deepened appropriately. Perhaps all borings should be 20 feet deep to allow for any cut, but at present, 15' borings are considered sufficient. Undisturbed samples should be taken, where possible, to allow evaluation of unconfined strengths of the various strata. As

unconfined strength of 1 ton is usually sufficient for single story frame houses such as those under consideration. For commercial and multi-story, 2 tons is usually adequate to insure against bearing capacity failure.

During field investigation it is important to make notes of existing fill, trees, thickets, old fence lines, roads, slope of each lot, topography, seeps, sinks, rock outcrops, and any area which may require fill to bring it up to grade before construction. Grading and drainage plans, when available, may be helpful in identifying some of these significant features. Note these fill lots or even suspected fill lots in the report so that proper care may be exercised by the insuring agency, city officials, design engineers, et. al. Uncompacted fill under the beams of an engineered slab will almost certainly create problems. Specify that all fill be acceptable material, properly compacted. H.U.D. projects and subdivisions are supposed to require that fill be placed in accordance with "Data Sheet 79-G".¹⁵

LABORATORY TESTING

After the proper field investigations have been made, it is necessary to run laboratory tests on samples from the various strata taken in the field. It is important that all strata be correctly identified and tested. Identification should be in accordance with the unified soil classifications chart shown in Fig. 2. Such terms as "caliche," "fat clays," "loam" and other colloquialisms should be avoided or used only as extra comment. Plotting liquid limits and plasticity indices on the classification chart will confirm field evaluations. If proper testing and identification are done, some degree of uniformity can be applied to Slab-on-Ground designs.

MAJOR DIVISIONS			GROUP SYMBOLS	TYPICAL NAMES
COARSE GRAINED SOILS More than 50% retained on No. 200 sieve*	GRAVELS 50% or more of coarse fraction retained on No. 4 sieve	CLEAN GRAVELS	 GW	Well-graded gravels and gravel-sand mixtures, little or no fines
		GRAVELS WITH FINES	 GP	Poorly graded gravels and gravel-sand mixtures, little or no fines
			 GM	Silty gravels, gravel-sand-silt mixtures
		 GC	Clayey gravels, gravel-sand-clay mixtures	
	SANDS More than 50% of coarse fraction passes No.4 sieve	CLEAN SANDS	 SW	Well-graded sands and gravelly sands, little or no fines
			 SP	Poorly graded sands and gravel-sand mixtures, little or no fines
		SANDS WITH FINES	 SM	Silty sands, and-silt mixtures
			 SC	Clayey sands, sand-silt mixtures
FINE GRAINED SOILS 50% more passes No. 200 sieve*	SILTS AND CLAYS Liquid limit 50% or Less	 ML	Inorganic silts, very fine sands, rock flour, silty or clayey fine sands	
		 CL	Inorganic clays of low to medium plasticity, gravelly clays, sandy clays, silty clays, lean clays	
		 OL	Organic silts and organic silty clays of low plasticity	
	SILTS AND CLAYS Liquid limit greater than 50%	 MH	Inorganic silts, micaceous or diatomaceous, fine sands or silts, elastic silts	
		 CH	Inorganic clays of high plasticity, fat clays	
		 OH	Organic clays of medium to high plasticity	
Highly Organic Soils		 PT	Peat, muck and other highly organic soils	

* Based on the material passing the 3 -in. (75-mm) sieve.

Figure 2

DETERMINING THE “EFFECTIVE P.I.”

The BRAB report bases its design procedure on the soil plasticity index (P.I.). This design procedure also uses the P.I. because it is a relatively simple-ple test which is routinely performed in all testing laboratories.

Since the soil is not always constant with depth, it is necessary to find the “effective P.I.” of the underlying 15 Feet. BRAB Report #33 suggests a weighing system (Fig.3).

rock layers can reduce the “effective P.I.” excessively making it appear to be a very innocuous site. It is probably best never to use zero for a P.I. Since BRAB recognizes 15 as a breaking point for Type III slabs, some minimum value such as 15 should always be used for those layers with little or no P.I. BRAB recognized the problem by utilizing the P.I. immediately below the slab if it was higher than the P.I. of the lower layers. This very conservative approach will always yield good, safe designs, considerably oversized.

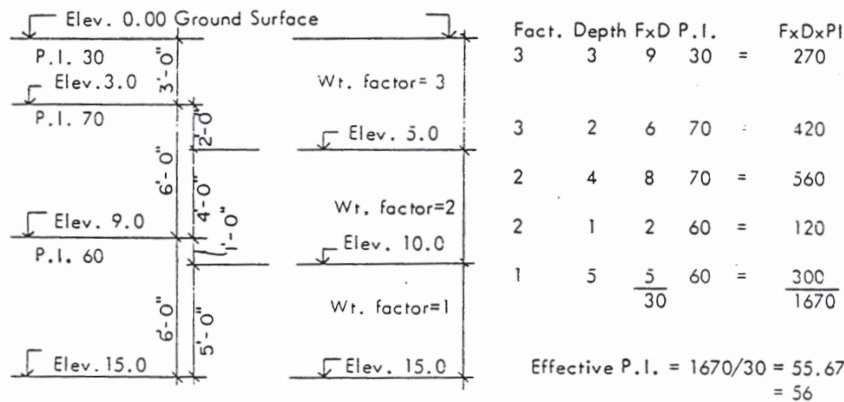

Figure 3

This seems as valid as any weighting method, as McDowell's^{16,17} procedure for calculating potential vertical rise also indicates that the upper few feet is the most active. The activity then decreases with depth due to confining pressure and protection from seasonal moisture change, etc. Any system that gives more attention to the surface soils is probably satisfactory. One place where this system might give erroneous results would be in formations which contain sand stringers or are overlaid by porous sand which would provide quick, easy routes for water to reach underlying or interbedded CH clays.

Another case would be high P.I. clays overlying rock. Using a zero (0) P.I. for these

OTHER PARAMETERS

Once the “effective P.I.’s” for each boring are calculated, they need to be modified by some other parameters. The slope of the lot should be used to increase the “effective P.I.” Figure 4 can be used to determine coefficients based on slope.

The degree of over-consolidation of the natural material can be estimated from the

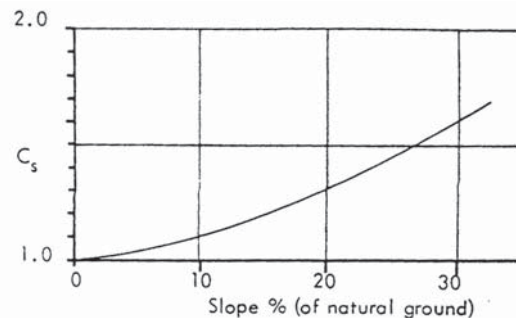

Slope of natural ground vs. Slope Correction Coefficient

Figure 4

unconfined compressive strengths. By using Fig. 5 a coefficient for over-consolidation can be determined.

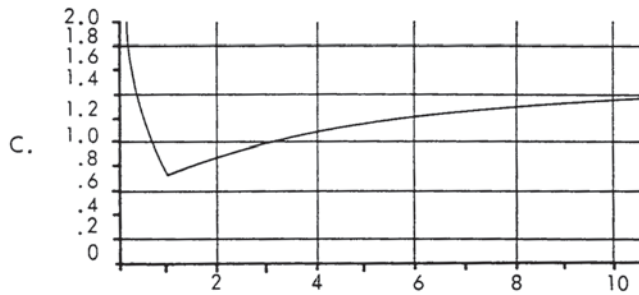

Unconfined Compressive Strength (q_u) TSF

Figure 5

Other factors are known to require consideration; moisture condition at time of construction, geologic formation, percentage of soil passing #40 sieve, percentage passing #200

sieve, all of these affect the potential volume change of the underlying soil. The correct value of “effective P.I.” is that from the equation:

$$\text{Eff. P.I.} () = \text{Effective PI} \times C_s \times C_o \times C_y \times C_z \dots C_n$$

Much work needs to be done in this area.

The ultimate performance of a slab reflects how well the soil analysis was done. Slab design is only as good as the soil data on which it is based. Some engineers say they do not need soil data to do a design. They are either deceiving themselves or are over-designing their slabs in which case they delude their clients and ultimately, the purchaser of the structure. There are few circumstances where the engineer is justified in over-designing and wasting the client’s money. There are no circumstances where the engineer is justified in under-designing--even at the client’s request.

WARNING

It should be recognized that there are certain conditions which neither this procedure nor any other will be able to anticipate. Examples of such problems which might cause difficulty, even to a well designed slab, would be the location of an old fence row beneath the foundations, a broken water pipe, improper drainage away from the foundation, a slab located on top of of previously existing tree or thicket, massive erosion or loss of support due to lack of compliance with proper site preparation standards, poor maintenance, or improper installation. There are numerous documented cases where slabs have exhibited less than the desired results due to one or more of these causes. Most of the causes mentioned above can be mitigated by proper construction and inspection. The others, such as old fence lines, trees, or thickets are generally unknown to the Soils Engineer and the Design Engineer, and, in many cases, cannot be anticipated at all. It is felt that the present state of the art make these conditions fall beyond those for which the designer can properly be considered responsible. The problem with this line of reasoning is that by the time it becomes apparent there is a problem with the slab, it is not possible in most cases to determine that the problem is one of those which could not be anticipated. The owner is having difficulty, and he is seeking relief, and quite often, revenge and restitution. These cases usually end up being decided by a jury. This is one very good reason for not trying to reduce the design standards too far and for trying to get a good standard adopted so it will be clearly defined when the engineer has done all that he can be reasonably expected to do.

LOADING CONSIDERATIONS

First look at a small slab for a single story house, trussed roof construction, masonry veneer, fire place and one car garage. What do the loads look like? (see Fig. 6)

1. Roof LL & DL, stud wall, brick veneer and ceiling loads
2. Brick chimney load
3. Stud wall and brick veneer
4. Wheel loads
5. Floor live loads (including non bearing partition allowances)
6. Concentrated loads from beam spanning garage doors

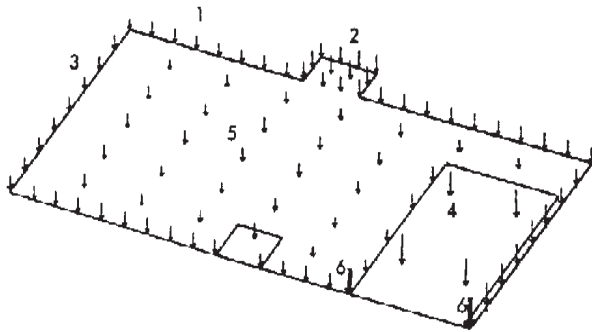

Superstructure Loads
Figure 6

Loads in Fig.6 are only the loads applied to the top of the slab. To these must be added the weight of the slab, edge beams, and interior stiffening beams. (see Fig.7).

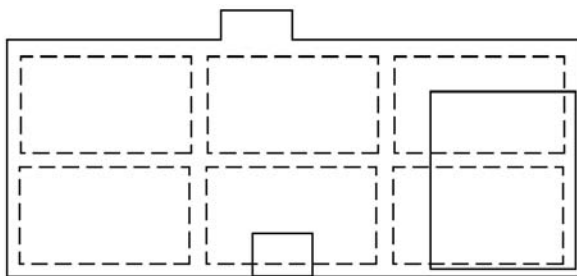

Slab Configuration
Figure 7

To the soil underneath, these loads are not nearly so clearly defined. For the small slabs

generally used under houses and small commercial buildings the loads can be assumed to be uniform. When the unconfined strength of the soil is less than 1 ton/sq. ft., settlement or bearing can be a problem and should be considered, but on stiff expansive clays any distress in the slab and superstructure will be caused by the volumetric movement of the soil due to moisture change. If the soil did not change, the weight of the house or small building would be transmitted directly through the slab and into the under-lying soil which with the exception mentioned above, can easily carry the weight since it is usually less than 500 lbs. per sq.ft.

Since the loads are small, it seems justified to use the simplifying assumption of a uniform load. This has given good results on single story residences.

SUPPORT CONDITIONS

Prior to the time the BRAB report was issued, the writer had been working on the problem some years and had developed a working design procedure.

The procedure involved an area of loss of support, (Fig. 8) the diameter of which was a function of the soil (P.I., degree of compaction, etc.) and which was allowed to move to any position under the building. The most critical locations, of course, were under load bearing walls and columns. The equation had been adjusted to give both positive and negative movements.

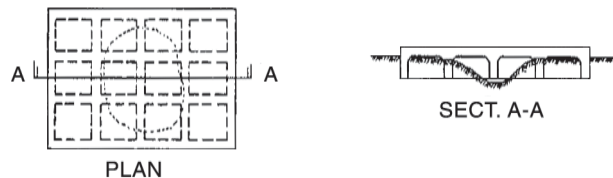

Area of Support Loss
Figure 8

This procedure was developed entirely from looking at slabs that seemed to work and those which did not and writing an equation which would produce sections equal to those which had been performing satisfactorily. Formulas had been developed which took into account loss in the center as shown above, loss at edges and corners. Also, there were provisions for inclusion of concentrated loads.

This procedure designed only one or two beams at a time. The BRAB report showed support conditions (see Fig.9) which allowed all beams in a given direction to be considered at one time. This simplified the design procedure, and, when the two design procedures were compared, they were found to give similar results. The BRAB procedure produced heavier-designs, but, with minor modifications, they could be adjusted

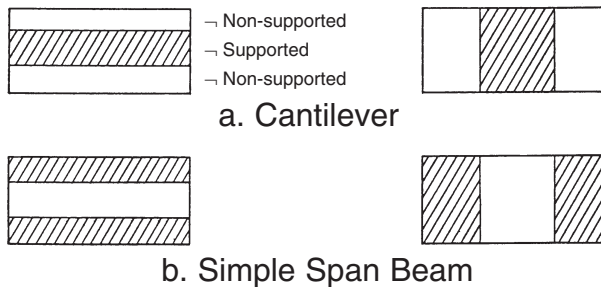

Assumed Support Conditions
Figure 9

The moment equations developed by BRAB give a maximum moment, both positive and negative at midspan (Fig. 10). This is not a simple cantilever moment. For short slabs it is a reasonable analysis. For longer slabs it quickly becomes excessive.

To eliminate the problem, several alternatives have been discussed:

- a. Design all slabs, longer than a certain

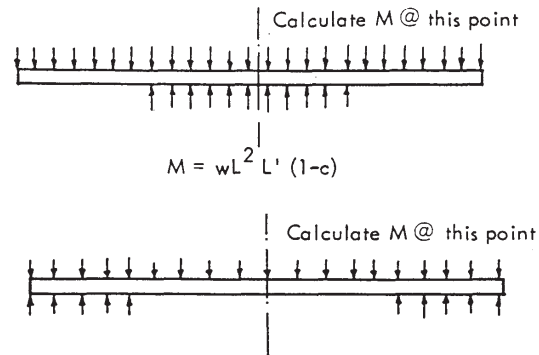

Location of Maximum Moment (BRAB)

Location of Maximum Moment
Figure 10

length, for a maximum moment based on that length and all slabs less than that, for their exact length (Fig. 11a)

- b. Use an effective length in the original BRAB equations. (Fig. 11b)
- c. Design all slabs for both positive and negative bending based on some cantilever length. (Fig. 12)

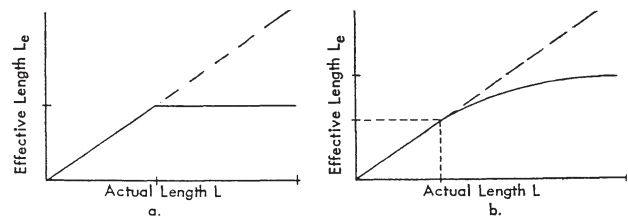

Length Modification Assumptions
Figure 11

Note that with Figure 11a there is no increase in design moment beyond the assumed maximum length. Obviously, as the slabs get longer, more reinforcing needs to be added to compensate for friction losses, drag, etc. P.C.I. goes into great detail to calculate these losses. By using an effective value for "L" as shown in Figure 11b, these losses are automatically covered. While this was a com-

pletely empirical approach, it was easy to use and gave good results.

It has been noted during previous research concerning slab-on-ground construction that the large slabs tend to reach an equilibrium in the center portion and fluctuate only with seasonal moisture change.

Some routine testing during the time of the soils investigations can reasonably define the depth of the zone of seasonal moisture change which, many say, is roughly equal to the horizontal distance moisture may pene-trate under a slab and cause differential movement or pressure. While this does indeed give a cantilever action such as was previously described, the point of maximum moment is not located at a distance from the edge equal to the depth of the seasonal moisture change and nato distance of $L(1-C)$. Much work has been done trying to ² define this cantilever distance. This design procedure has developed an empiri-cal curve which, when used with the equa-tions set out later, gives good results. Again, it makes no difference whether the cantilever theory is used or the BRAB equations are used, so long as the proper input is supplied for either criteria.

The BRAB equations utilizing an effective length, as opposed to the total length, were used for years and gave good results. Since the P.C.I. and P.T.I. have advocated a can-tilever approach, this procedure has been modified to use a cantilever (see Fig. 12) which gives the same results as the modified BRAB equations. Note that in cases both positive and negative reinforcing are sup-plied.

There is, at this time, a great deal of dis-cussion concerning the relative equality of

the positive and negative moments used in design. It seems that a large number of engi-neers feel that the positive moment is not as significant a design parameter as is the negative moment. Numerous proposals have been offered for the reduction of the positive moment. A look at the loading conditions on most slabs will offer support to this reduction theory, and some experimental work has been undertaken by this firm to evaluate this proposal. The results observed indicate that some reductions are justified and allowable. To date, no findings have been brought forth, backed by any performance data, to indicate what magnitude of reduction should be con-sidered.

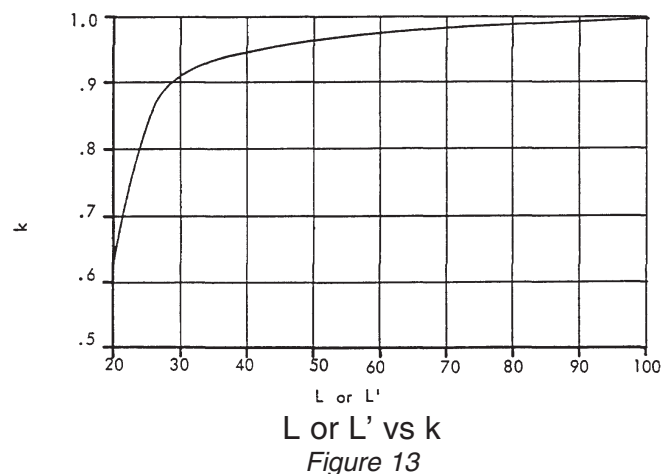
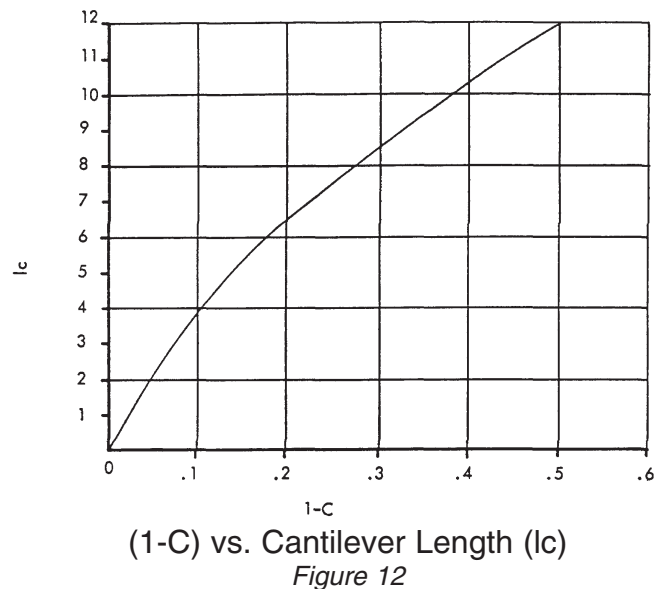

THE SLAB DESIGN

The proper procedures for soils investigations and reporting have been mentioned in this report, and, assuming that the proper information is available, an actual foundation design can be begun. The design procedure begins by determining a unit weight of the building including its foundation. Assume that such weight is distributed uniformly over the entire foundation area. Those conditions where concentrated loads are felt to be of such magnitude that they must be considered, are not covered in this paper.

As previously stated, the weight of the structure is not so significant as the support conditions of the underlying soil material, however, the weight calculated in these procedures is generally indicative of the amount of differential movement which can be tolerated by the superstructure. The heavier the unit weight, the more brittle and sensitive to movement is the superstructure material in general. Also, heavier loads generated by multi-story buildings indicates that additional

stiffness must be supplied to the foundation because of the sensitivity of multi-story buildings to differential movement. A very light wood frame structure with wood siding and no masonry would be far less susceptible to structural and cosmetic damage than would be a heavy all-masonry or brick veneer type building. Use of these increased unit weights automatically generates additional moment and deflection criteria to satisfy the need for additional stiffness and strength.

These criteria, incidentally, apply to residential and small commercial construction and not to the more monumental type structures such as banks, churches, and highrise building. These same design procedures could be used for these types of buildings, reducing the allowable deflections and stresses, and including allowances for high concentrated loads to produce the more rigid foundations necessary for this type construction.

In any event, assume that for this criteria the calculated weight of the house, including the foundation for one story brick veneer type construction, is "w" lbs. per sq. ft. (The value 200 can be used for almost any single story woodframe, brick veneer type construction and not be too far from the actual weight of the house).

With the weight of the house known, refer to Fig. 14 which is extracted directly from BRAB report to select the climatic rating for the city in which the house is to built. The values for Texas range

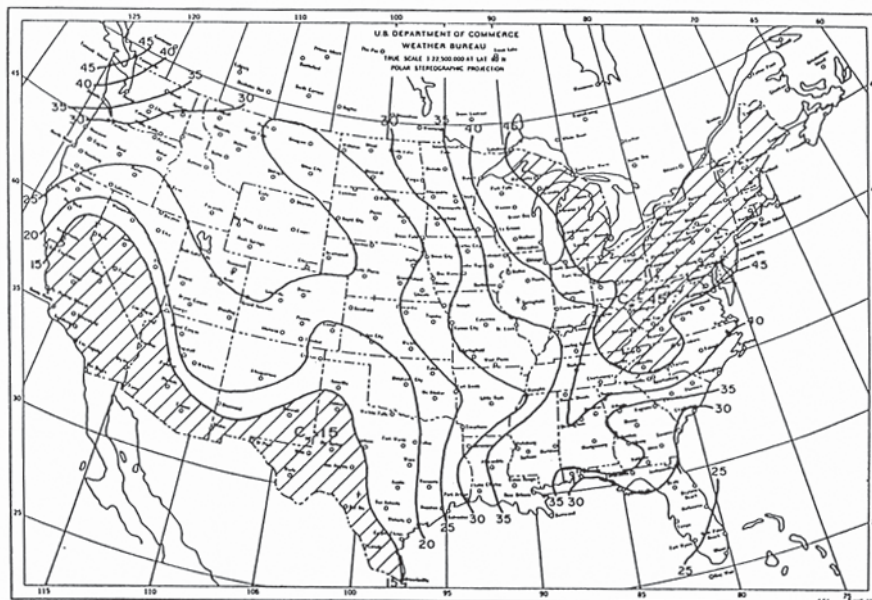

Climatic Rating (C_w) Chart
Figure 14

from 15 in west Texas to as high as 30 in east Texas. This chart reflects the stability of the moisture content which may be expected in the soil due to the climatic conditions which may vary from year to year. A very low number indicates an arid climate which will be very low humidity and low ground moisture except for a few weeks or months of the year when a heavy rainfall will occur and the ground will take on a considerable amount of moisture creating a potential for a large volumetric change in a short period of time. The larger numbers, such as those in east Texas, indicate in general a more humid climate where the moisture content of the soil tends to remain more uniform the year round. Refer to the BRAB report for a more complete description of this chart.

The P.I. and the climate conditions now being known, it is possible to select from Fig. 15 the soil-climate support index, indicated as (1-C).

The following formulas will be used to calculate the moment, shear and deflection, using the equivalent lengths shown in Fig. 14 as previously discussed.

$$M = \frac{w L' (Lc)^2}{2}$$

$$\Delta = \frac{w (Lc)^4 L'}{4 E_c I}$$

$$V = w L' Lc$$

Where: M = Moment, positive or negative

Δ = Deflection in inches

V = Total shear

w = Unit weight

L' = Width of slab considered

Lc = Cantilever length (lck)

E_c = Creep modulus of Elasticity of concrete

I = Moment of Inertia of section

These calculations are performed for both the "Long" and "Short" directions. The actual value of L and L' are used when they refer to the width of the slab. The most critical of these is deflection. A slab which deflects too much will cause serious problems for the superstructure, even though the slab does not actually break. In general then, it is best to solve first for "I required".

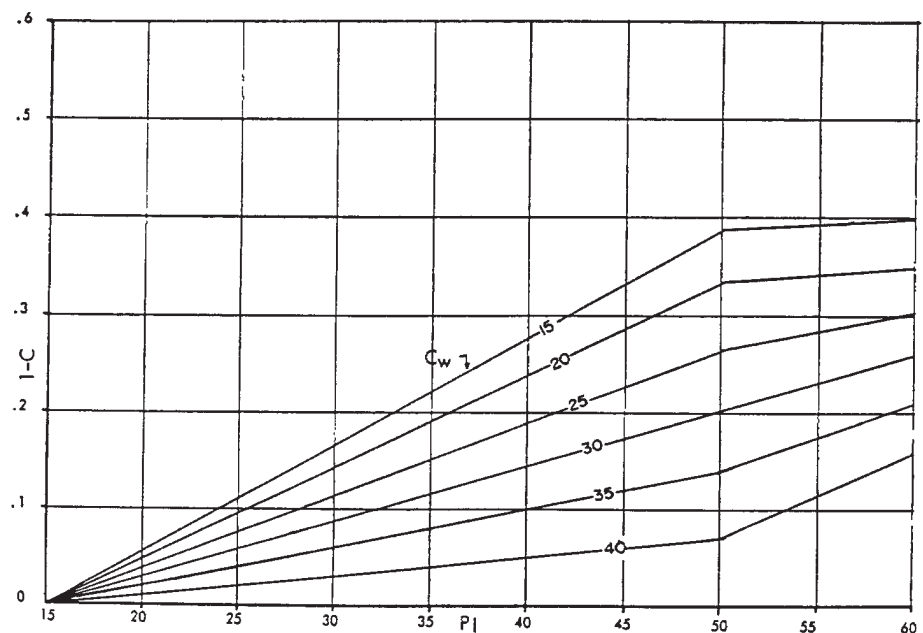

PI vs. (1-C)
Figure 15

The cross. section of slab is not known, but the value of 200 lbs./sq.ft. is almost always adequate to include the slab weight.

BEAM SPACING AND LOCATION

Almost all houses, if not a basic rectangle, can be divided into two or more rectangles. If the building under consideration is a combination of two or more rectangles, a set of calculations must be done for each rectangle. The rectangles are then overlaid and the heavier design governs the common areas as shown in Fig. 16. Obviously there will be times when good engineering judgement is required, as all houses are not nice neat modules.

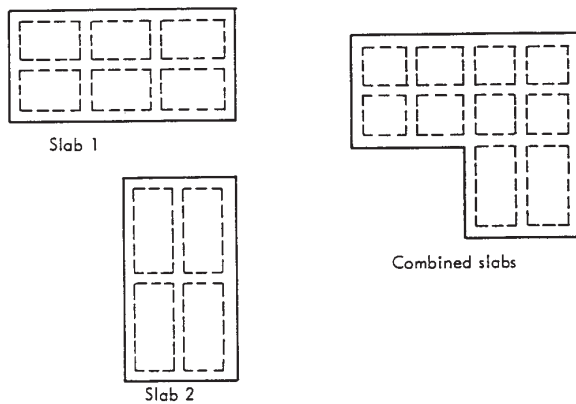

Slab Segments and Combined
Figure 16

On some occasions the geometry of the house will dictate where the beams are to be placed. When this is the case, the beams can be located, and the calculations carried out for width and depth based on the known number of beams in each rectangle.

If the design seems excessively heavy by using the maximum spacing's, it is possible to recalculate beam depths and reinforcing based on supplying additional beams.

Once the spacing and location are known, the size of the beams can be determined by trial and error. BRAB specifies that the maximum face to face distance between beams should be 15'. P.C.I. states the maximum should be 20'. Experience has shown that these are

very conservative values. They are to apply to any slab on soil with P.I. of 15 or above. This is a very rigid requirement. Perhaps a more rational approach is one such as is shown in Fig. 17.

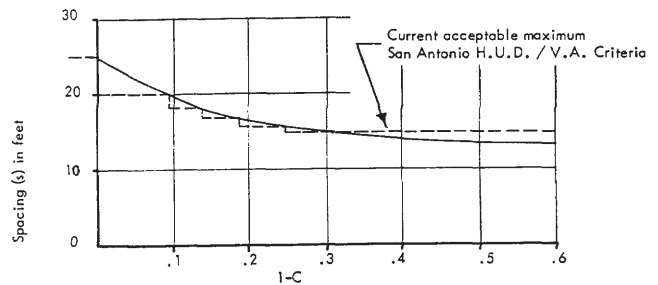

1-C vs. Maximum beam spacing
Figure 17

The designer can then use a chart such as the one shown, or the various maximums to make the first run. The number of beams then will be:

$$\text{No.} = \frac{L}{S} + 1 \quad \text{Where } S = \text{Spacing from the chart}$$

With the number of beams known, a width for each can be selected, and a calculation made for the moment of inertia. If desired, a very good first approximation can be made by using the following formulas.

$$\begin{aligned} \text{Reinforcing Steel} \quad d &= \sqrt[3]{\frac{664 M L_c}{B}} & \text{Where: } d &= \text{Beam Depth} \\ & & B &= \text{Sum of all beam widths} \\ & & M &= \text{Moment in KF} \\ & & L_c &= \text{Cantilever length} \\ \text{Prestresses} \quad d &= \sqrt[3]{\frac{553 M L_c}{B}} \end{aligned}$$

The difference in the two equations takes into account the cracked section moment of inertia vs. the gross section allowed in the prestressed slab. Anyone not wishing to use the gross section moment of inertia can use the reinforcing steel for both type slabs. These equations are good only with beam spacings no greater than those shown in Fig. 17.

These solutions will give you “N” no. of beams “b” inches wide and “d” inches deep which will give you an “I” in the order of magnitude required to limit deflection to 1/480*. It is pointless to argue about the relative merits of 1/360 vs. 1/480. In most cases depths based on 1/360 will not be economical when it comes to selecting reinforcing.

This design moment has been used to select a cross section which will resist deflection. It is now necessary to provide the reinforcing. Referring back to the BRAB (also PCI) it is necessary to provide both positive and negative reinforcing.

* ACI 318-77, Table 9.5 (b) page 12 recommends 1/480 for roof or floor construction supporting or attached to non-structural elements likely to be damaged by large deflections.

SLAB REINFORCING

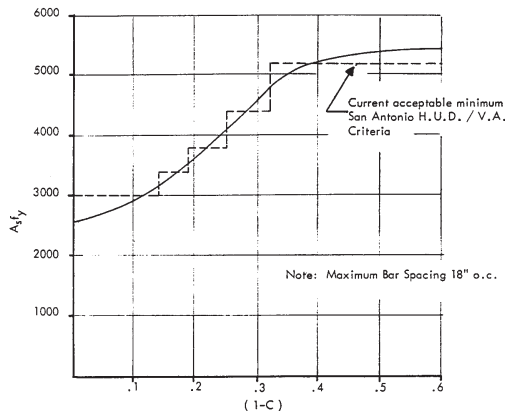

1-C vs. $A_s f_y$
Figure 18

BRAB states again an arbitrary maximum spacing; the only choices are #3 bars at 12” ($A_s f_y = 4400$ lbs./ft. with Grade 40, or 6600 lbs./ft. with Grade 60 bars), or in a 5” slab, or #3 bars at 10” ($A_s f_y = 5200$ lbs./ft. with Grade 40, 7920 lbs./ft. with Grade 60 bars) O.C. in a 4” slab when the beam spacing exceeds 12 feet. Both are excessive in most cases. As long as the beam spacing does not exceed

that shown in Fig. 17, it is possible to use less slab reinforcing.

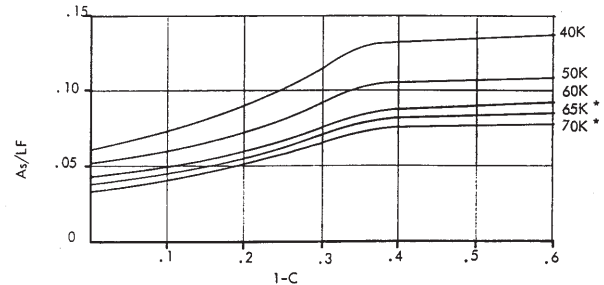

(1-C) vs. A_s/LF
Figure 19

ACI would limit the minimum reinforcing to $A_s f_y = 3840$ for Grade 40 and $A_s f_y = 5184$ for Grade 60 in a 4” slab. That is not realistic. Slabs-on-ground are not as sensitive to temperature change as suspended slabs, and need much less reinforcing. Many slabs have been done with $A_s f_y$ less than 2600 with no ill effects. These are on low P.I. designs, of course. On high P.I. sites, the requirements of $A_s f_y = 5200$ as recommended in BRAB is reasonable. (Fig. 18)

*ACI 318-77 allows $A_s/LF - 0.0018 \times \frac{60,000}{f_y}$ which will further reduce the 0.0020 or 0.0018 requirements when reinforcement with yield strengths exceeding 60,000 PSI measured at a yield strain of 0.35 percent are specified.

BEAM REINFORCING

Solve for top beam steel based on negative moment, include slab steel falling within the cooperating slab area. (see Fig. 20).

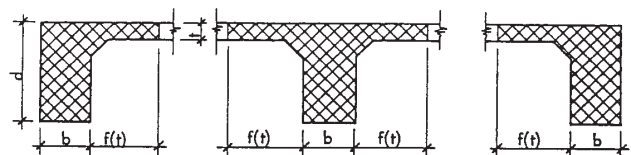

Effective Width of “T” Beams
Figure 20

Solve for the bottom steel based on calculated (reduced if feasible) positive moment. Put the same size bars in a beam if 2 or more are required. It is usually best not to use more than 3 bottom bars in each beam. If that much steel is required, deepen the beams to increase the lever arms or add more beams or both.

SITE PREPARATION

Often the most overlooked part of the entire operation is the site preparation. The proper sequence should include the following:

1. Site clearing
2. Excavation (if any)
3. Fill selection and placement

Inadequate attention to any of these phases can cause foundation problems even years after the slab is built.

It is very important that the site be cleared of all grass, weeds, old decaying or decayed organics, roots and trash. This material when left under the slab can and will continue to decay and cause settlement at later dates. It is surprising how little settlement is required to cause superstructure distress. The removal of approximately six inches of top soil is usually adequate to remove grass, weeds, etc. and their roots. Trees and large bushes generally require grubbing to greater depths to insure adequate removal. This site clearing should be done prior to beginning any required excavation.

Excavation of on-site material can begin after the clearing and grubbing is completed. This allows any acceptable on-site fill material uncovered to be placed or stockpiled without contamination. This is desirable when practical because it is cost effective to handle the material only once. When a continuous,

simultaneous cut and fill operation can be arranged, it will save the owner-developer quite a bit in site preparation costs.

When, for some reason, this operation cannot be arranged, it is necessary to stockpile or waste the excavated material. Stockpiles should be made on prepared sites. They should be cleared the same as a building site. Wasting should be in an area which will not be utilized later for building and which will not be subject to erosion or create drainage blockage.

All on-site material which is not suitable for structural fill should be wasted or removed from the site.

Fill selection is usually governed by the expansive qualities of the natural soil. Fill should always be as good or better than the on-site material on which it is placed. Sometimes more than one type of fill may be used.

In general, lot preparation in subdivisions is poorly done. Side slope lots requiring cut and fill on each lot are usually done without any effort to select the best material or supply any compaction to the fill.

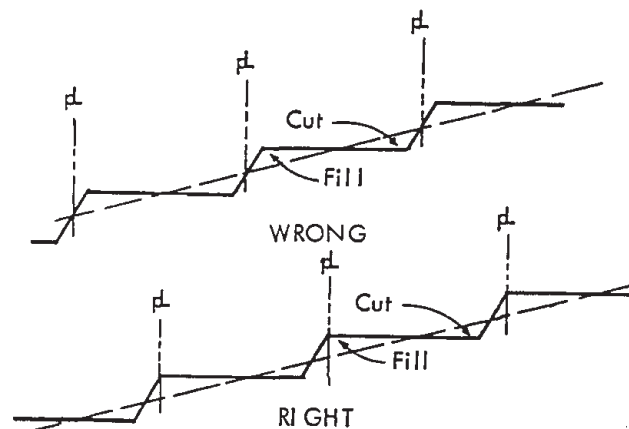

Side Slope Lots
Figure 21

SLAB FORMING

1. Foundation forms are to be built to conform to the size and shape of the foundation, and should be tight enough to prevent leaking of mortar. The bracing must be designed so that the concrete may be vibrated without displacement or distortion of forms.
2. Beams should be formed by one of two methods:
 - a. Single family slabs have been traditionally done by placing loose fill inside the forms and forming the beams with paper sacks filled with sand or fill material. For small, lightly loaded slabs this seems adequate.
 - b. Large slabs such as apartments, warehouse, shopping centers, etc., are often beamed by placing compacted fill to underslab grade and then trenching the beams with a power trencher. This method adds support to the slab and, helps it resist deflection by effectively reducing the potential expansion of underlying soil.

Unless specified on the plans or specifications for single family foundations, it is assumed that the method described in “a” above will be used. Method “b” may be used if desired, but it is not required. For multi-family foundations or commercial work, method “b” should be required.

3. After the beams are Formed, a waterproof membrane should be placed.** Either 6 mil poly or hot-mopped asphalt impregnated felt may be used. The waterproofing

should be lapped adequately to provide a continuous sheet under the entire slab. When poly is used, care must be taken to see that it does not become entangled in the reinforcing. Nailing the beam sides to the fill just before placing helps. At the exterior beam, the poly should be cut off at the bottom inside face of the beam and nailed as shown (Fig. 22), carried up onto the exterior form and nailed (Fig. 23), or lapped with felt and nailed (Fig. 24).

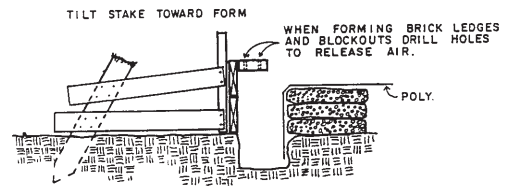

Edge Beam Forming and Staking
Figure 22

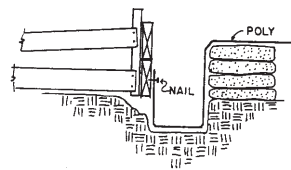

Edge Beam Forming
Figure 23

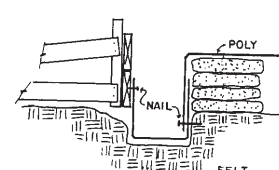

Edge Beam Forming
Figure 24

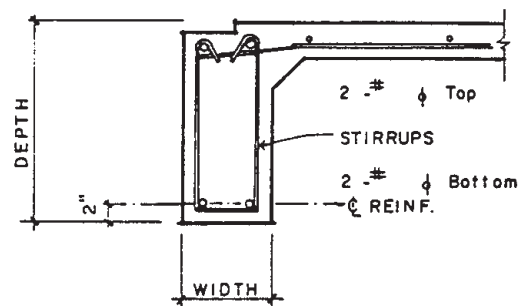

Typical Steel Placement
Figure 25

* Not universally accepted, even by all HUD/VA offices, but currently used in San Antonio-Central Texas area.
**There is much discussion over the membrane requirement, but it currently is a HUD/VA requirement.

STEEL PLACEMENT

1. For the most part, steel placement in the beams will be two bars in the top and two in the bottom (Fig. 25). The bars will be held in position by stirrups at appropriate spacing. The spacing should be that which will assure the proper positioning of the steel. The bottom bars should be set on concrete bricks or blocks to keep them raised above the bottom of the beams. Corner bars equal in size to the larger size (maximum size - #6 bars) of any bars meeting at an exterior corner (Fig. 26) should be provided both top and bottom. Where interior beams dead end into exterior beams, corner bars should be supplied for bottom reinforcing only and should be the same size as the bottom bars in the interior beam or #6 bar maximum. (Fig. 27)

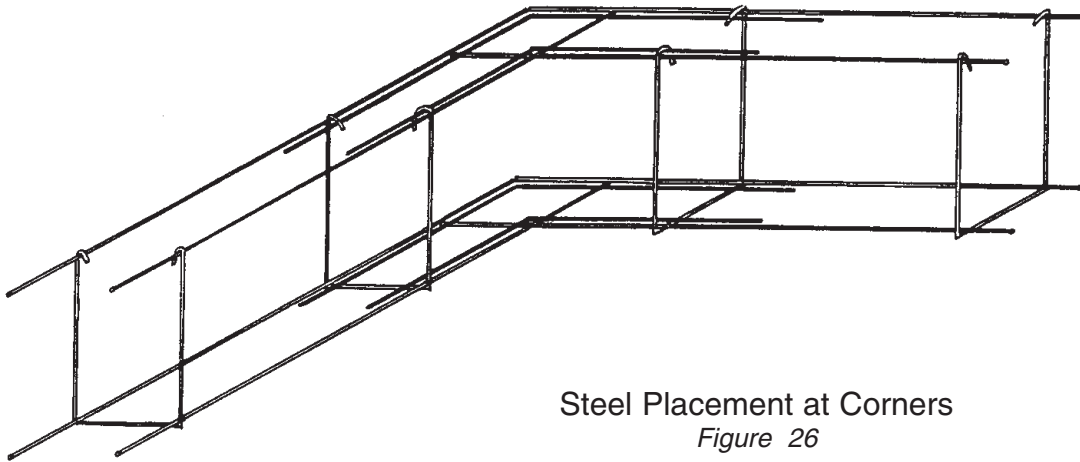

Steel Placement at Corners
Figure 26

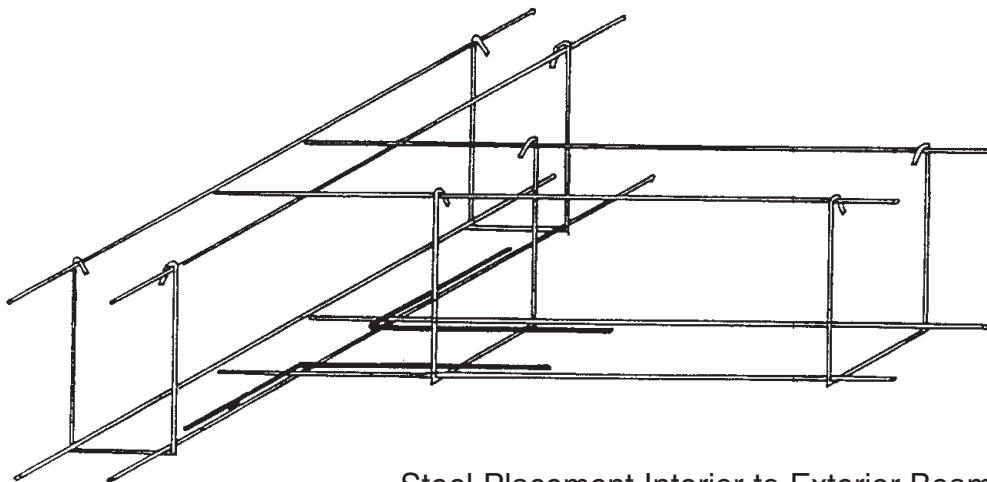

Steel Placement Interior to Exterior Beam
Figure 27

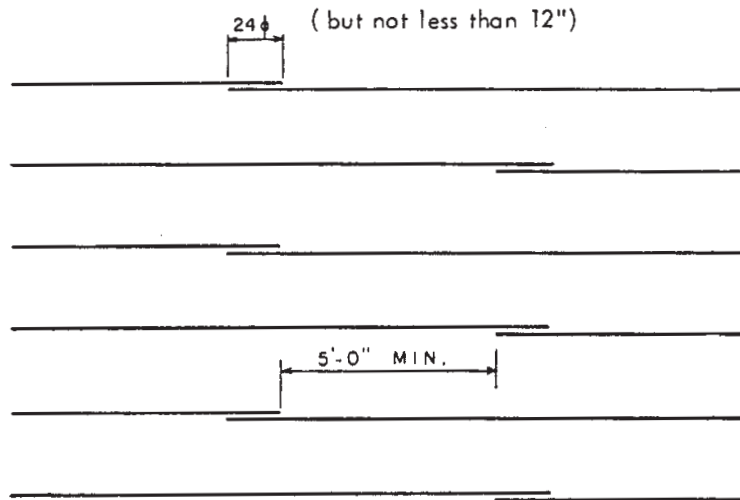

Stagger Laps in Slab Steel
Figure 28

- After the beam steel is in place, the slab steel is placed. If it is necessary to lap slab steel, the laps in adjacent bars should be staggered at least 5' - 0" (Fig. 28)

The slab steel is run continuously from side form to side form (lapping 24 diameters mm. where splices are required), allowing 1-1/2" cover over the ends of the bars. On the edges where the bars run parallel to the form, the first bar should be placed a maximum of 12" from the outside form. All slab steel should be securely tied and blocked up by chairs or concrete briquettes. (Figures 29 & 30)

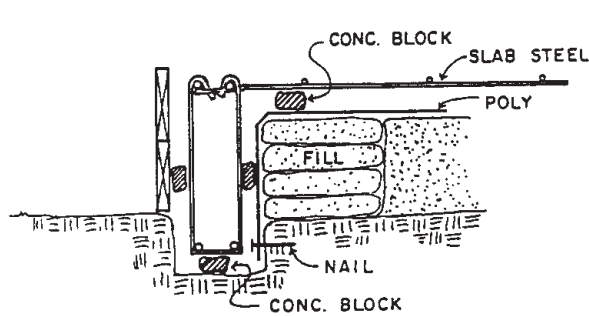

Blocking Steel Exterior Beam
Figure 29

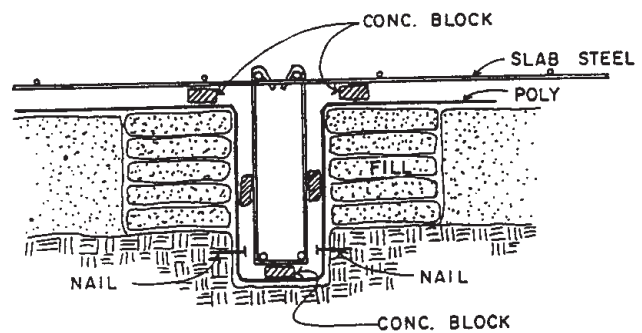

Blocking Steel Interior Beam
Figure 30

- To insure the lowest possible foundation cost the use of welded wire reinforcement for slab reinforcement should be investigated. Different styles of WWR can furnish the same steel area and the following are suggested for design example:

Welded Plain Welded Wire Reinforcement

ASTM Specification A 185, $f_y = 65$ KSI

$$A_s \text{ req'd} = .098 \times 40/65 = .060 \text{ in}^2/\text{ft.}$$

$$\text{Est. wt.} = 42\#/\text{CSF}$$

WWR 4 x 4 - W2 x W2

6 x 6 - W3 x W3

12 x 12 - W6 x W6

12 x 12 - W6 x W6 with 2-W3 outside edge wires @ 4" c/c each side.

Welded Deformed Welded Wire Reinforcement

ASTM Specification A497, $f_y = 80$ KSI

$$A_s \text{ req'd} = .098 \times 40/70 = .056 \text{ in}^2/\text{ft. est.}$$

$$\text{wt. } 36\#/\text{CSF}$$

WWR 16 x 16 - D6.5 x D6.5 with one D3.8 outside edge wire each side.

The two welded wire reinforcement styles with 12" spacing for smooth wire and 16" spacing for deformed wire have been recently developed to further improve the efficiency of welded wire reinforcement. The larger wire spacings make it possible to install the welded wire reinforcement at the desired location in the slab because it permits the workmen to stand in the openings and raise the welded wire reinforcement to place the supports.

All welded wire reinforcement sheets must be spliced at both sides and ends to develop the full design f_y . For smooth welded wire reinforcement ACI 318-77 requires that the two outside cross wires of each sheet be overlapped a minimum of 2 inches and the splice length equals one spacing plus 2 inches with a minimum length of 6 inches or $1.5 l_d$ whichever is greater. For slabs on ground

the one space + 2 inches or 6" minimum will prevail. This means that for a 12" wire spacing the minimum side lap splice would be 14" but by spacing the 2 edge wires at 4" the lap is reduced to the minimum of 6". In addition the lapping of 2 wires in the splice length will provide twice the required steel area. By reducing the area of the 2 edge wires by 50%, the required A_s is provided uniformly throughout the width of the slab. This reduction in wire size does not reduce the capacity of the splice because ASTM Specification A-185 provides that the weld strength shall be not less than 35,000 times the area of the larger wire. These tonnage saving features apply only to side laps but many welded wire reinforcement manufacturers can provide sheets with variable transverse wire spacings and the length of end laps can be reduced even though wire sizes cannot.

The length of splice for deformed welded wire reinforcement is determined by the size and spacing of the spliced wires, and only the outside cross wire is lapped. While the lap length cannot be changed, the size of the outside cross wire can be reduced without changing the strength of the lap. ASTM Specification A497 stipulates that the weld shear strength shall not be less than 35,000 times the area of the larger wire. These engineered welded wire reinforcement styles are not generally available for small foundation slabs, but, when numerous small buildings or large slabs are being considered, it is prudent to check with welded wire reinforcement suppliers because substantial savings in cost can often be accomplished. As with rebar reinforcing, welded wire reinforcement must be chaired or supported on brick or blocks to insure proper placement in the slab.

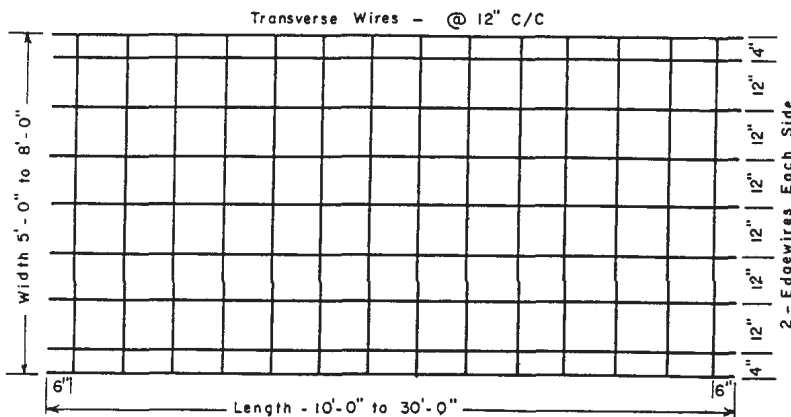

Engineered Welded Wire Reinforcement Sheet with Special Side Laps
Welded Smooth Welded Wire Reinforcement

Figure 31

SPECIAL CONDITIONS

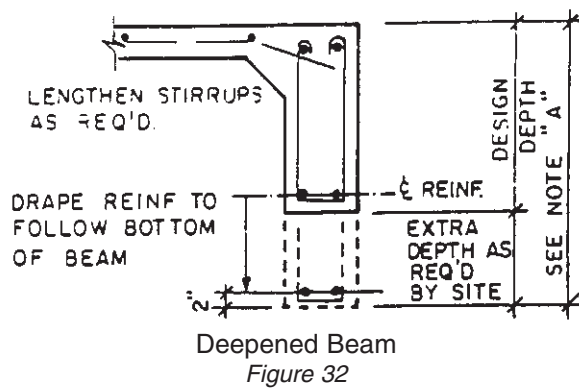

Deepened Beam
Figure 32

NOTE "A"

1. WHEN OVERALL DEPTH EXCEEDS 36" ADD 1 - #3 HORIZONTAL IN EXTERIOR FACE OF BEAM FOR EACH 18". START SPACING 6" FROM THE TOP.
2. FOR BEAMS 36" TO 54" DEEP USE #3 STIRRUPS AT MAXIMUM 24" O.C.
3. FOR BEAMS 54" TO 72" DEEP USE #3 STIRRUPS AT MAXIMUM 18" O.C.
4. FOR BEAMS OVER 72" DEEP CONTACT ENGINEER FOR SPECIFIC DETAILS.

1. Special conditions from time to time will arise which will require modifications to beam depths, forms, etc. Many of these are covered by typical details which illustrate what modifications are allowed without approval from the Engineer. If a special condition occurs, such as a deep

beam, the Contractor needs instructions in the typical details telling how to handle the situation. In the case of the deep beam, deepen the beam by the required amount and relocate steel (Fig. 32). Refer to "Note A" to see if additional steel is required. Obviously, if the beam exceeds 72", the engineer must be contacted for additional information.

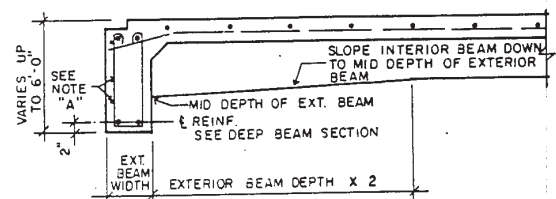

Interior to Exterior Beam
Figure 33

2. When an exterior beam is deepened, some slight changes must be made to the interior beams which intersect the deepened beam (Fig. 33). The bottom of the interior beam should slope down at least as deep as the mid-depth of the deepened exterior beam. If the interior beam depth is already deeper than the mid-depth of the deepened exterior beam, no changes are required to the interior beam.

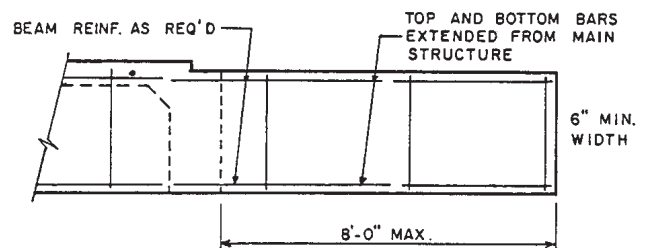

Extended Concrete Beam
Figure 34

3. Extended beams to carry wing walls should be handled as shown in the typical detail (Fig. 34). It is very important that

the additional top reinforcing be added as shown; otherwise the beam may be broken off.

5. Other special conditions may arise from time to time but they are too numerous to be covered here.

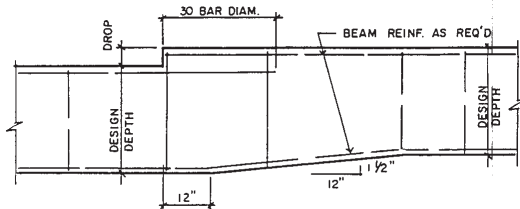

Side View of Typical Beam at Drop
Figure 35

4. Beams that continue through drops must be deepened by the amount of the drop, and the transition sloped (Fig. 35). If the drop is framed as a sharp corner on the bottom of the beam, stress concentrations can occur which may cause difficulties.

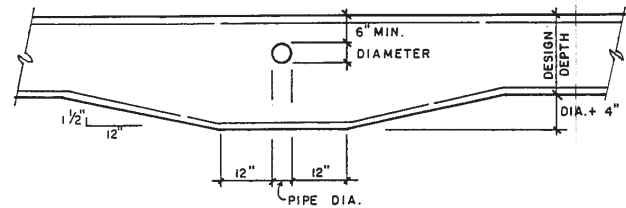

Drop under Sleeve through Beam

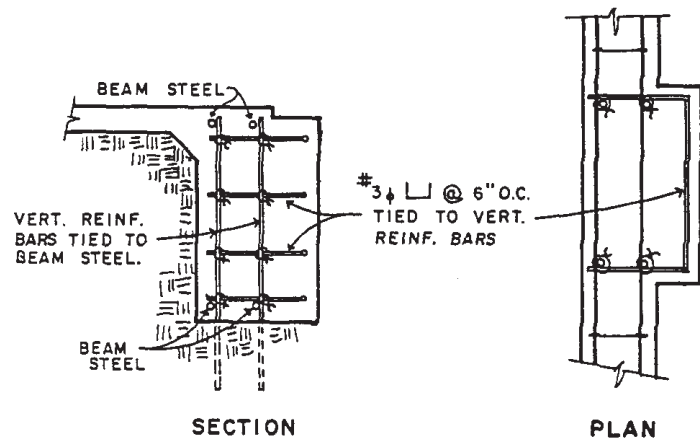

Side View of Typical Beam at Drop
Figure 36

CONCRETE PLACING

Over the years the word “pouring” has come to be used almost exclusively to describe the function of placing concrete. Unfortunately that term is all too descriptive of the practice which has become common throughout the industry. When placing concrete for an engineered foundation, it is imperative that the concrete actually be placed, not “poured”.

Residential floors need to have adequate strength, surfaces that are hard and free of dusting, and the cracking should be held to a minimum. The hardness and finish of the surface will depend on how densely the surface materials are compacted during finishing, and the adequacy of the cement paste.

Cracking however is mainly a function of the drying shrinkage which takes place immediately after placing and is generally more controlled by atmospheric conditions than by the consistency of the concrete itself. This is a gross generalization, however, as high water cement ratios will increase the shrinkage problem. Good concrete for slabs-on-ground should be made from a mix in which the water cement ratio is kept low and should contain as much coarse aggregate as possible at the surface. Compressive strengths for concrete slab-on-ground foundations are generally specified as a minimum of 2500 PSI at 28 days. It is important to note the word minimum. The 2500 PSI should be the minimum strength, not the average strength.

This 2500 PSI is a generally accepted figure in the industry, since it has become an accepted figure for HUD/VA construction.

In keeping the water cement ratio low, add mixtures can be of particular benefit. This is particularly true with respect to air entrainment, retardants and accelerators.

Calcium chloride is a common cold weather additive to accelerate setting and hardening. It should properly only be added to the mix in the mixing water. It is important to emphasize that calcium chloride is not to be used in a foundation which is pre-stressed. The use of calcium chloride in foundations with rebar reinforcing or welded wire reinforcing must be limited to a minimum of 2% by weight of cement.

Several operations need to be completed before beginning the placing of concrete. Screeds should be set inside the form area to establish finished slab grade prior to beginning concrete placing. This will improve the level of the finished slab and eliminate much of the unevenness of the slabs currently found. Keys for joints may, on certain occasions, be used as screeds, since they need to be placed at proper intervals in large slabs to eliminate or control the shrinkage cracking.

When the concrete is delivered it should be placed as close as possible to its final position in the foundation. It should be spread with short handle, square ended shovels and not by the use of rakes. Internal vibration at the time of placing should be mandatory, as this allows a stiffer mix to be used and facilitates placing.

Screeding, tamping, and bull floating will be of course finished prior to the time the bleed water has accumulated on the surface. After

the bull floating, the final finishing should not begin until bleed water has risen and evaporated, and the water sheen has disappeared from the surface. At the time the concrete shall be stiff enough to sustain a man's foot pressure without indentation.

With regard to final finishing operations, the accumulation and evaporation of bleed water will vary considerably with weather conditions and types of mixes. When bleed water is too slow to evaporate, it may be pulled off with a hose, or blotted with burlap. The surface of a foundation should never be dried with what is commonly called dusting. This is a method whereby dry cement and, sometimes, dry cement and sand is placed on the slab to blot the bleed water. This will cause a weak surface and, possibly, subsequent deterioration of the surface.

Immediately after the foundation has been finished, a curing compound should be placed to inhibit further evaporation of water from the concrete mix. This will tend to reduce the amount of shrinkage cracking which will occur in the foundation.

When using a liquid curing membrane, it is important to select a compound that will not interfere with future bonding of floor finishes. There are several such compounds on the market.

Forms should remain on the finished concrete slab for a minimum of 24 hours. Removal prior to that time can cause damage to the concrete. After 24 hours the forms can be carefully removed without damaging the concrete.

INSPECTION

The most general problem encountered was lack of suitable field inspection and control. If the foundations are not constructed in accord with the design drawings and specifications, then benefits to be derived from improvements in codes or the state of the art will be diminished.”²⁰

Before placing, the contractor should call for an inspection by some inspection agency. For FHA-VA single family construction, this is handled by the FHA or VA. For non FHA/VA houses it is, or should be, handled by the city, but most cities, especially small ones, do not have enough staff.

Cities should require adequate inspection,, either by their own forces, or by the design engineer who should, after all, be most familiar with his own design.

When the Engineer is not permitted to check the construction, one of the other inspectors should furnish a certificate to the Engineer that the slab is properly installed in accordance with the Engineer s plan. The following is a partial list of points which should be verified by the inspector.

1. Check number of beams
2. Measure beam width
3. Measure beam depth
4. Check beam spacing
5. Check tightness and alignment of forms
6. Check blocking under beam reinforcement
7. Check compliance with fill penetration or have fill certification
8. Check beams for proper number and size of reinforcing bars
9. Check the slab reinforcing for proper size and spacing.
10. Check to see that all slab reinforcing is adequately blocked to insure proper placement in concrete.
11. Test concrete for maximum 6” slump
12. Make cylinders for strength certification
13. See that concrete is vibrated or rodded
14. Insure adequate curing
15. Check for cracking or honeycombing

SHRINKAGE CRACKS

All concrete has cracks! There is not yet in the industry the ability to produce crack-free concrete. What can best be done is to limit or reduce the amount and kinds of cracks.

Those cracks that occur prior to the hardening of the concrete are generally formed by the movement of the form work, settlement of the concrete during setting, or plastic shrinkage cracks which occur while the concrete is still plastic. Other cracks which can occur after the setting of concrete are shrinkage cracks due to drying of the concrete, thermal cracks due to changes in internal heat of hydration or due to external temperature variations, cracks due to stress concentrations, or cracks due to structural overloads.

The most common cracks which are seen in foundations are plastic shrinkage cracks which occur early after the concrete is placed and are due to the rapid drying of the fresh concrete. Even if plastic cracking does not occur, similar type cracks can form during the early stages of hardening even days after the final finishing has taken place. While curing membranes will not eliminate the plastic shrinkage cracks that occur prior to setting, they can be very beneficial in reducing or eliminating the shrinkage cracks which will occur after finishing.

The effects of temperature, relative humidity, and wind velocity are, in general, beyond the control of the engineer or the contractor and must be accepted as risks when the slab is placed.

It is, therefore, wise to specify the minimum sacks of concrete which will be expected to give the recommended compressive strength, utilize the minimum water content necessary

for workability, and not permit over-wetting of concrete on the job. It cannot be said too often that the use of internal vibration will facilitate placing of concrete and help eliminate internal settlement. The use of a surface curing membrane, placed as soon as possible after final finishing, will help eliminate shrinkage cracks which are caused by drying of the hardened concrete.

It is common practice in commercial work to use control joints to reduce shrinkage crack problems. These are good procedures, but not commonly used in single family construction.

Again, it is important to recognize that all shrinkage cracks cannot be eliminated, given the present state of the art.

NOTATION

A_c	=	Gross Area of Concrete Cross-Section
A_{ss}	=	Area of Steel Reinforcing in Slab
A_{sbb}	=	Area of Steel Reinforcing in Bottom of Beam
A_{stb}	=	Area of Steel Reinforcing in Top of Beam
a	=	Depth of Stress Block (ult. strength)
b_b	=	Width of Beam Portion of Cross-Section
b_s	=	Width of Slab Portion of Cross-Section
B	=	Total Width of all Beams of Cross-Section
C_w	=	Climatic Rating
d_b	=	Depth of Beam Portion of Cross-Section
d_s	=	Depth of Slab Portion of Cross-Section
E	=	Modulus of Elasticity of Concrete
E_c	=	Creep Modulus of Elasticity of Concrete
f'_c	=	28 Day Compressive Strength of Concrete
f_y	=	Yield Strength of Reinforcing
I_g	=	Gross Moment of Inertia of Cross-Section
I_o	=	Moment of Inertia of Segments of Slab Cross-Section
k_l	=	Length Modification Factor-Long Direction
k_s	=	Length Modification Factor-Short Direction
L	=	Total Length of Slab in Prime Direction
L'	=	Total Length of Slab (width) Perpendicular to L
L_c	=	Design Cantilever Length (l_{ck})
l_c	=	Cantilever Length as Soil Function
M_l	=	Design Moment in Long Direction in kft
M_s	=	Design Moment in Short Direction in kft
N_l	=	Number of Beams in Long Direction
N_s	=	Number of Beams in Short Direction
PI	=	Plasticity Index
S	=	Maximum Spacing of Beams
V	=	Design Shear Force (Total)
v	=	Design Shear Stress (Unit)
v_c	=	Permissible Concrete Shear Stress
w	=	Weight per sq. ft. of House and Slab
q_{allow}	=	Allowable Soil Bearing
q_u	=	Unconfined Compressive Strength of Soil
$i-c$	=	Soil/Climatic Rating Factor
Δ_{allow}	=	Allowable Deflection of Slab, in.

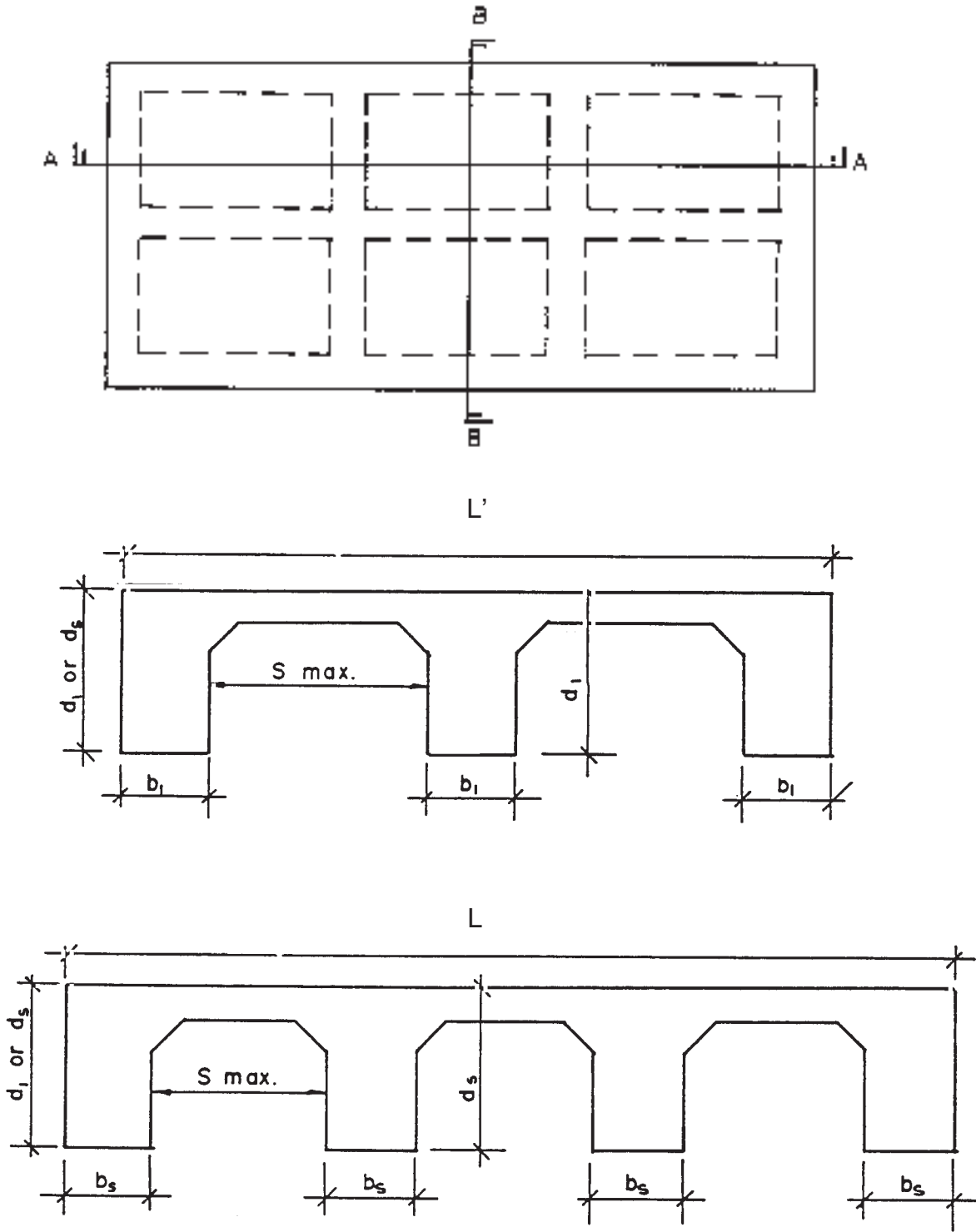

Minimum number, width and depth of beams

DESIGN EXAMPLES

For comparison to BRAB Report #33, assume for a design example the same single story residence located in San Antonio, Texas, which was used in BRAB Report #33.

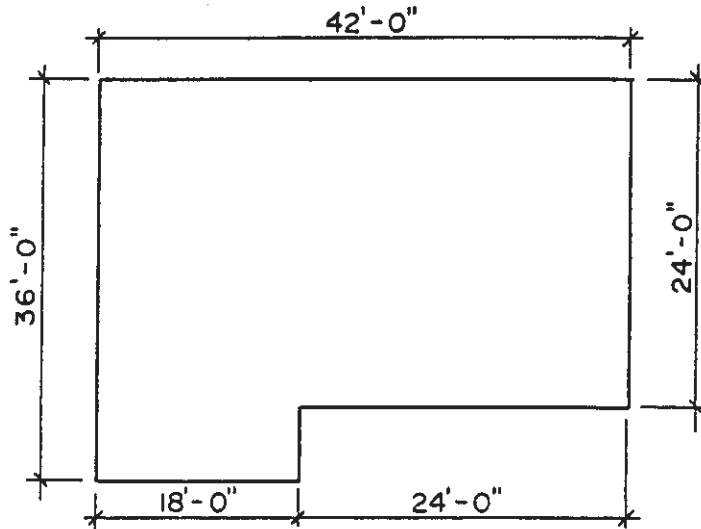

Assume:

Effective P.1. = 37
Climatic rating C = 17
Slope = 0%

3 x 5 x 41 = 615
2 x 5 x 41 = 410
5 x 15 = 75
EPF P.1. = 1100/300 = 36.67

Unconfined compression $q_u = 2800 > 1$ TSF.
Unit weight = 200 lbs./sq. ft.

First divide slab into two overlapping rectangles.

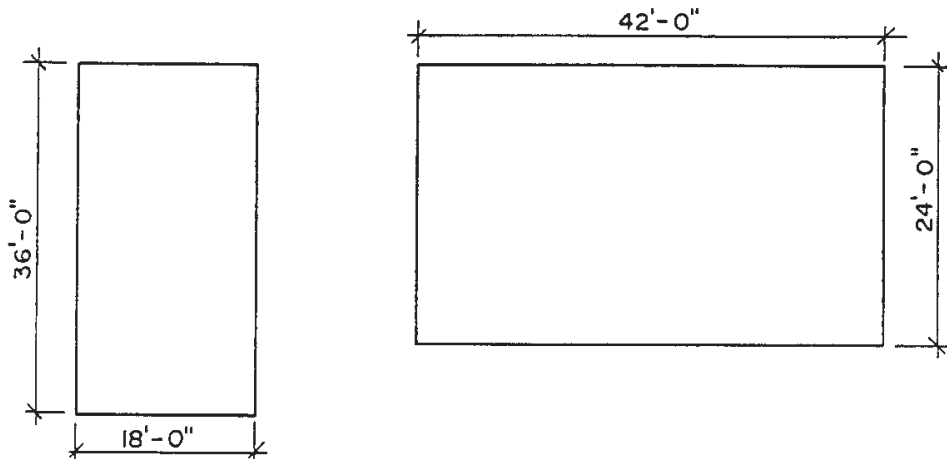

For purposes of example, solve the 24' - 0" x 42' - 0" rectangle

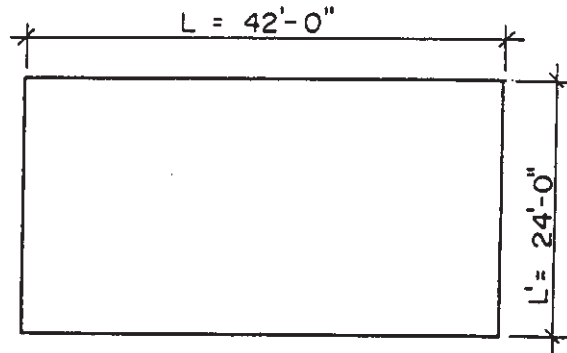

From Fig. 15, $1-C = .23$

From Fig. 17, $S = 16$

From Fig. 12, $l_c = 7$

From Fig. 13, $K_l = .95$ $K_l l_c = .95 \times 7.0 = 6.65$
 $K_s = .80$ $K_s l_c = .80 \times 7.0 = 5.60$

Number of beams in long direction $N_l = \frac{24.0}{16.0} + 1 = 2.5 = 3$

Number of beams in short direction $N_s = \frac{42.0}{16.0} + 1 = 3.6 = 4$

Assume beam widths = 9" each beam

$$B_L = 3 \times 9 = 27''$$

$$B_S = 4 \times 9 = 36'' \text{ Geometry of house causes 5 beams } B_S = 45$$

Solve for long and short moments:

$$M_L = \frac{200 (6.65)^2 \times 24}{2000} = 106 \text{ kf}$$

$$M_S = \frac{200 (5.60)^2 \times 42}{2000} = 132 \text{ kf}$$

Solve for beam depths:

$$d_L = \sqrt[3]{\frac{664 \times 106 \times 6.65}{27}} = 25.9'' = 26''$$

$$d_S = \sqrt[3]{\frac{664 \times 132 \times 5.60}{45}} = 22.2'' = \text{"say 22"}$$

Solve for steel in bottom of beams : Long direction

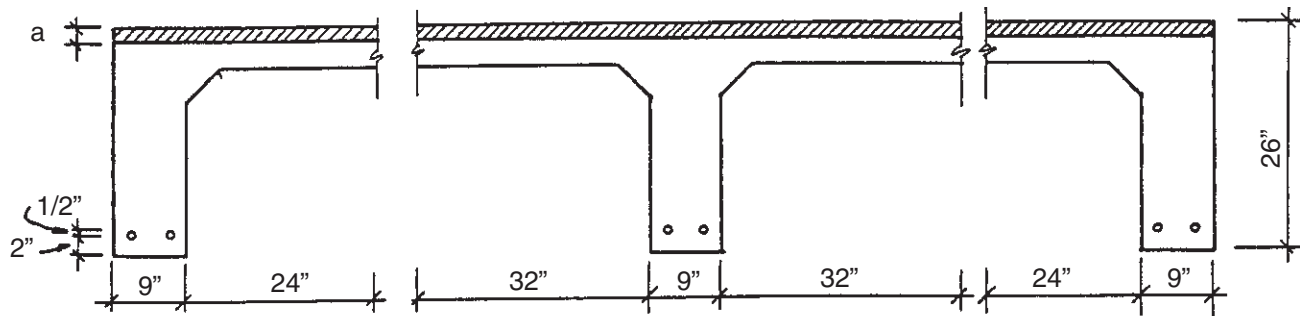

Using $f_y = 60,000$

Assume: 6 - #5 bars $A_s = 1.86$ sq.in.

$$a = \frac{A_s f_y}{0.85 f' c b} = \frac{1.86 \times 60,000}{0.85 \times 2500 \times 139} = 0.378$$

Assume: lever arm for positive reinforcing = $d - 3''$

$$M_U = 1.86 \times 60 (26 - 3) / 12 = 213.9$$

$$M = 213.9 / 1.6 = 133.7 \text{ vs. } 106$$

or using $f_y = 40,000$

Assume: 6 - #6 bars $A_s = 2.64$ sq.in.

$$a = \frac{A_s f_y}{0.85 f' c b} = \frac{2.64 \times 40,000}{0.85 \times 2500 \times 139} = 0.358$$

Assume: lever arm for positive reinforcing = $d - 3''$

$$M_U = 2.64 \times 40 (26 - 3) / 12 = 202.4$$

$$M = 202.4 / 1.6 = 126.5 \text{ vs. } 106$$

$A_s f_y$ for all three of these combinations = 3.85 k/lf

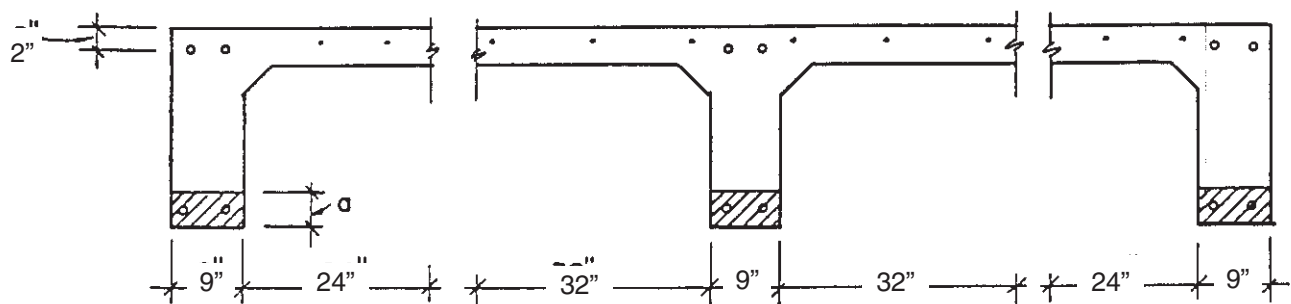

Assume lever arm for negative reinforcing = $d - 4''$

- M_u from slab steel - steel in flanges only

$$112'' / 12 \times 3.85 \times (26-4) / 12 = 65.9 \text{ kf}/1.6 - 41.2$$

$$-M - 41.2 \text{ kf} = \text{Moment to be reinforced for } 106 - 41 = 65 \text{ kf}$$

For $f_y = 60,000$

Assume: 6 - #4 bars $A_s = 1.20$

$$M_u = 1.20 \times 60 \times (26' - 4'') / 12 = 132$$

$$M = 132 / 12 = 82.5 > 64$$

For $f_y = 40,000$

Assume: 6 - #5 bars $A_s = 1.86$

$$A_s f_y = 1.86 \times 40 = 74.4 \text{ k}$$

$$M_u = 74.4 \times (26-4) / 12 = 126.4 \text{ kf}$$

$$M = 136.4 / 1.6 = 85.2 > 64$$

A cross section taken across the slab would then show:

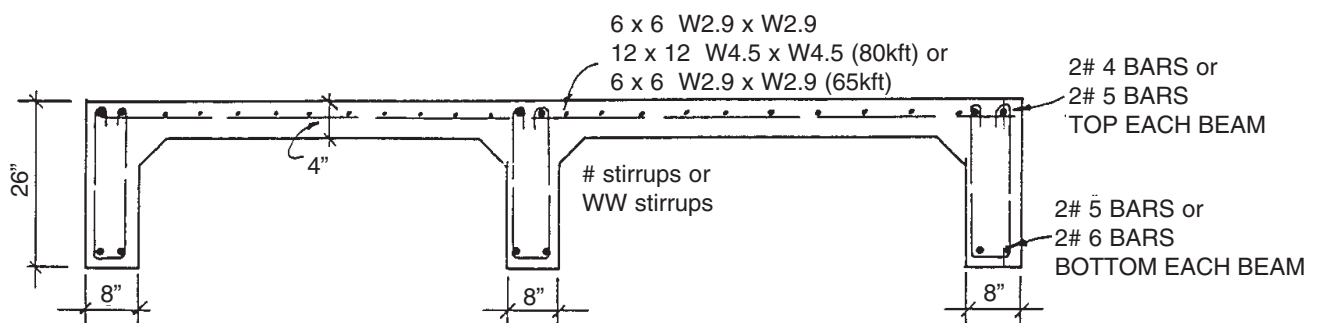

Solve for steel in bottom of beams : Short direction

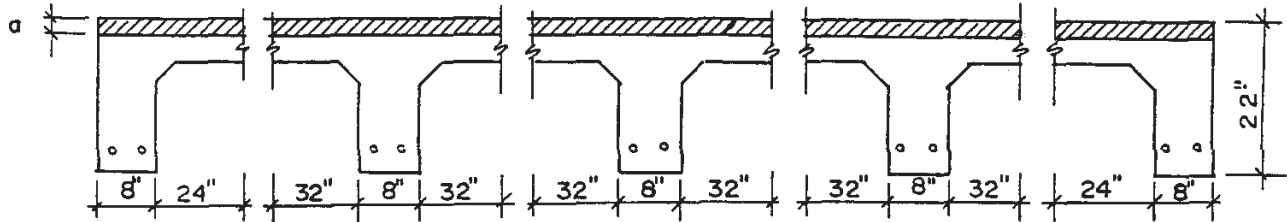

For $f_y = 60,000$

Assume: 10 - #4 bars $A_S = 2.00$

$$a = \frac{2.00 \times 60}{0.85 \times 2.5 \times 240} = 0.235''$$

Assume: lever arm for negative moment = $d-3$

$$M_U = 2.00 \times 60 (22-3) / 12 = 190.0$$

$$M = 190 / 1.6 = 119 \text{ vs. } 132$$

Try increasing two exterior and center beams to 26"

$$M_U (\text{ext. beams}) = 1.80 \times 60 (26-3) / 12 = 138 \text{ kft}$$

$$M_U (\text{int. beams}) = 0.80 \times 60 (22-3) / 12 = 76 \text{ kft}$$

$$\text{Total } M_U = 138 + 76 = 214 \text{ kft}$$

$$\text{Total } M = 214 / 1.6 = 134 \text{ vs. } 132$$

For $f_y = 40,000$

Assume: 10 - #5 $A_S = 3.10 \text{ sq.in.}$

$$a = \frac{3.10 \times 40}{0.85 \times 2.5 \times 240} = 0.243''$$

Assume: lever arm for negative moment = d-3

$$M_u = 3.10 \times 40(22-3) / 12 = 196\text{kft}$$

$$M = 196/1.6 = 122 \text{ vs. } 132\text{kft}$$

Try increasing two exterior beams to 26"

$$M_u \text{ (ext. beams)} = 1.24 \times 40 (26' 3'') / 12 = 95\text{kft}$$

$$M_u \text{ (mt. beams)} = 1.86 \times 40(22' 3'') / 12 = 118$$

$$\text{Total } M_u = 95 + 118 = 213\text{kft}$$

$$\text{Total } M = 213/1.6 = 133 \text{ vs. } 132$$

Solve for steel in top of beams: Short direction slab steel same as long direction

-M slab steel - steel in flanges only

$$M \text{ slab steel } 240 / 12 \times 3.85 (22' 4'') / 12 = 111.6 / 1.6 = 73.5\text{kft}$$

-M -73.5 = 132 -73.5 = 58.5kft moment to be reinforced for.

(This is slightly conservative since beams are deepened)

For $f_y = 60,000$

Assume: top steel to be 10 - #3 bars or W or D9 @ 10" ea. way

$$-M_u = 0.66 \times 60 (26-4) / 12 = 72.6$$

$$0.44 \times 60 (22-4) / 12 = 39.6$$

$$\text{Total } -M_u = 72.6 + 39.6 = 112.2$$

$$-M_u = 112.2 / 1.6 = 70.1 > 58.5$$

For $f_y = 40,000$

Assume: top steel to be #3 bars or W or D9 @ 10" ea. way

$$-M_U = 0.80 \times 40 (22-4) / 12 = 58.7$$

$$1.20 \times 40 (22-4) / 12 = 72.0$$

$$\text{Total } -M_U = 130$$

$$-M = 130.7 / 1.6 = 81.7 > 58.5\text{kft}$$

SUMMARY:

Long Direction Beams

3-9" x 26" beams, reinforced with 2 #4 or 2 #5 bars top, 2 # 5 or

2 #6 bars bottom each beam

Short Direction Beams

2-9" x 26" exterior and center interior beams, reinforced with

2 #3 or 2 #4 bars top, 2 #4 or 2 #5 bars bottom.

2-9" x 22" interior beams, reinforced with 2 #3 or 2 #4 bars top,

2 #4 or 2 #5 bars bottom.

Slab reinforcing to be:

$$f_y = 80,000 - 12 \times 12 - W4.5 \times W4.5$$

$$f_y = 65,000 - 6 \times 6 - W2.9 \times W2.9$$

REFERENCES

1. Tentative Recommendations for Prestressed Slab-On-Ground, Ad Hoc Committee of the P.C.I. Post-Tensioning Committee Chicago.
2. Interim Criteria for Slab-On-Ground Concrete Foundations for Residential Construction”, Construction Research Center, University of Texas at Arlington. Dr. E.L. Buckley, P.E., PhD
3. Criteria for Selection and Design of Residential Slab-On-Ground, Report#33 to the Federal Housing Administration, Publication 1571, National Academy of Sciences, Washington, D.C., 1968.
4. Home Builders Protest New Slab Design Criteria, Engineering News Record, Vol. 176, No.1 Jan.6, 1966,
5. Lytton, R.L., “Stiffened Mat Design Considering Viscoelasticity, Geometry and Site Conditions”, Proceedings, 3rd International Conference on Expansive Clays, Vol.11, Haifa, Israel.
6. Snowden, Walter L., Personal notes and inspection reports, memos and correspondence with others, unpublished, 1967 to present.
7. Dawson, Raymond F., “Movement of Small Houses on an Expansive Clay Soil”, Proceedings. 3rd. International Conference on Soil Mechanics and Foundation Engineering, Zurich, Vol.1, 1953
8. Snowden, Walter L. and Meyer, Kirby T., “Comparison of Performance of Slab-On-Ground Foundations on Expansive and on Non-Expansive Soils”, paper presented to Texas Section American Society of Civil Engineers, Soil Mechanics Division, San Antonio, Texas. 1967.
9. Anderson, R.B. and Thompson, H.Platt, “Analysis of a Prestressed Post-Tensioned Foundation Using the Kelly System”, H.Platt Thompson Engineering Company, Inc., Houston, Texas January 31, 1968.
10. Meyer, Kirby T., and Lytton, R.L., Foundation Design in Swelling Clays”, Texas Section American Society of Civil Engineers, Soil Mechanics Division, Austin, Texas, 1966.
11. Matlock, Hudson and Haliburton, T.A., “BMCOL 29, a program for Finite Element Solution of Beam Columns on Non-Linear Supports”, 1335 Bonham Terrace, Austin, Texas June 15, 1964.

12. Matlock, Hudson, "GRDBM 23, Random Direction Beam System Computer Program", unpublished class notes, The University of Texas, Austin, Texas, 1965.
13. Lytton, R.L., "Analysis for Design of Foundations on Expansive Clays", Geomechanics Journal, Institute of Business Australia, 1970.
14. Lytton, R.L. and Meyer, Kirby T., "Stiffened Mats on Expansive Clays", Journal, Soil Mechanics and Foundation Division, ASCE Vo. 97, No. SM7, July 1971.
15. "Land Development with Controlled Earthwork", Data Sheet 79-G, HUD Handbook 4140.3 Land Planning Data Sheet Handbook, U.S. Department of Housing and Urban Development, Washington, D.C. June 19, 1973.
16. McDowell, Chester, "Interrelationship of Load, Volume Change, and Layer Thickness of Soils to the Behavior of Engineering Structures", Vol. 35, Highway Research Board Proceedings.
17. McDowell, Chester, "Remedial Procedures used in the Reduction of Detrimental Effects of Swelling Soils", TPI-65E, Texas Highway Department.
18. "Structural Failures: Modes, Causes, Responsibilities", A Compilation of Papers Presented at the "ASCE National Meeting on Structural Engineering", Cleveland, Ohio, April 1972.
19. Thornwaite, C.W., 1948, "An Approach Toward a Rational Classification of Climate", Geographical Review, V.38
20. Olson, Ray E., "A Study of Foundation Failures & Distress", Report for National Bureau of Standards, Gaithersberg, Maryland, July, 1973.
21. ACI Committee 318, "Building Code Requirements for Reinforced Concrete (ACI 318)", American Concrete Institute, Farmington Hills, MI.



WIRE REINFORCEMENT INSTITUTE®

TECH FACTS

Excellence Set in Concrete®

TF 700-R-03
Update

942 Main Street • Suite 300 • Hartford, CT 06103 (800) 552-4WRI [4974]

DESIGN OF SLAB-ON-GROUND FOUNDATIONS

An Update

A Design, Construction & Inspection Aid For Consulting Engineers

March, 1996

Prepared for:

Copyright, Wire Reinforcement Institute

Wire Reinforcement Institute

942 Main Street

Hartford, CT 06103

Phone (800) 552-4WRI [4974]

Fax (860) 808-3009

Authored By:

Walter L. Snowden, P.E.

2613 Passion Flower Pass

Cedar Park, TX 78613

Phone: 512-331-6159

Fax: 512-331-6002

Email: wlspe@sbcglobal.net

This report is furnished as a guide to industry practice. The Wire Reinforcement Institute (WRI) and its members make no warranty of any kind regarding the use of this report for other than informational purposes. This report is intended for the use of professionals competent to evaluate the significance and the limitations of its content and who will accept the responsibility for the application of the material it contains. WRI provides the following material as a matter of information and, therefore, disclaims any and all responsibility for application of the stated principles or the accuracy of the sources other than material developed by the Institute.

INTRODUCTION

In 1981 “DESIGN OF SLAB-ON-GROUND FOUNDATIONS, A Design, Construction & Inspection Aid for Consulting Engineers” was first published. The design procedure set forth in that publication had at that time been in use by the author for about 15 years. After this publication, it was subsequently adopted by the Uniform Building Code (UBC) as Standard 29-4(l). Copies of this work have been distributed by WRI for 22 years to consultants all across the nation. Feedback has been most favorable with no comments of design inadequacy. In a few cases there have been suggestions that this procedure produced extra conservative designs, but this guide is intended to always produce a safe, serviceable foundation. Engineers who care to are free to exercise their judgement and to adjust the results in either direction.

SOILS INVESTIGATIONS

It is still mandatory that soils investigation be made on any site to set out the necessary conditions for design. The original recommendation of a minimum of one boring for each isolated site is still valid, but many insuring agencies have specified at least two borings in areas where expansive clay is found. Large sites and subdivisions will need a specific planned program utilizing several borings. Subdivisions will usually average about one boring for every 3 or 4 contiguous lots. Borings should be a minimum of 15 feet deep in most cases, and in some instances will need to be deeper. The soils Engineer should be sure to obtain adequate information to cover any grading changes which can be anticipated. Fill should be identified and noted. Uncompacted fill placed on a site, and improper drainage have been found to be the largest contributors to unsatisfactory foundation performance. Either one or both are guarantees of foundation problems.

During the last 22 years, many alternatives to an adequate on-site investigation have been proposed; soils maps, adjacent data, guesses, and something called a “max design”. A “max design” is supposedly a design for the maximum soil condition in the area. How is that known unless an on-

site investigation has been done? That is another name for a guess.

What remains true is that the performance of the slab is influenced primarily by the underlying soil. If the severity of the soil is underestimated, the foundation will not be satisfactory. It is therefore essential to know what type soil conditions exist, and that can only be known through an adequate site investigation.

LOADING CONDITIONS

For one, two, and even three story wood frame construction such as homes and small commercial buildings, the assumption of uniform load works well with the design equations. If there are large concentrated loads or numerous columns, attention must be paid to the location of stiffening beams or thickened areas of the slab so that the load can be spread out. Buildings which are carried totally on columns need a different analysis from a uniform loading assumption.

DESIGN ASSUMPTIONS

The design procedure presented originally by The Building Research Advisory Board (B.R.A.B.) in their Report 33, assumed a loss of support at the edges (Fig 1a) and a loss of support at the center (Fig 1b).

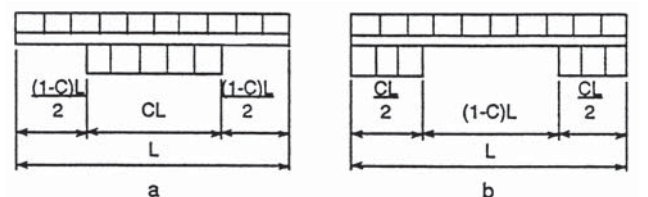

Figure 1

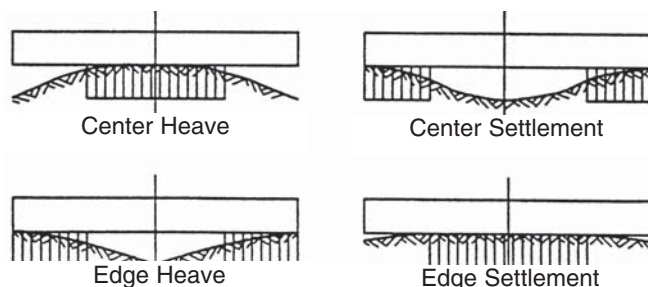

Figure 2

These conditions approximated the conditions of center heave or edge settlement and center settlement or edge heave as shown in Figure 2.

By making some simplifying assumptions it was possible to analyze the foundation slab by applying the loading conditions in both the long and short directions (Figure 3).

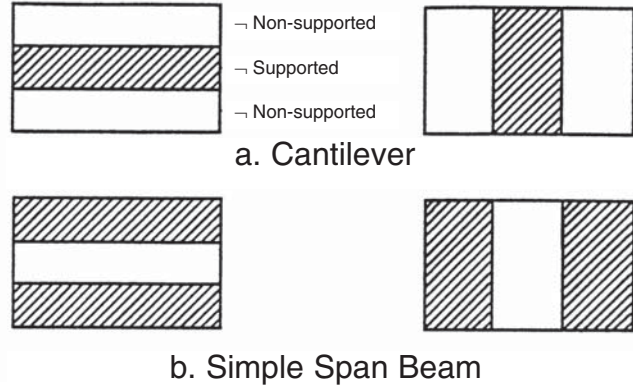
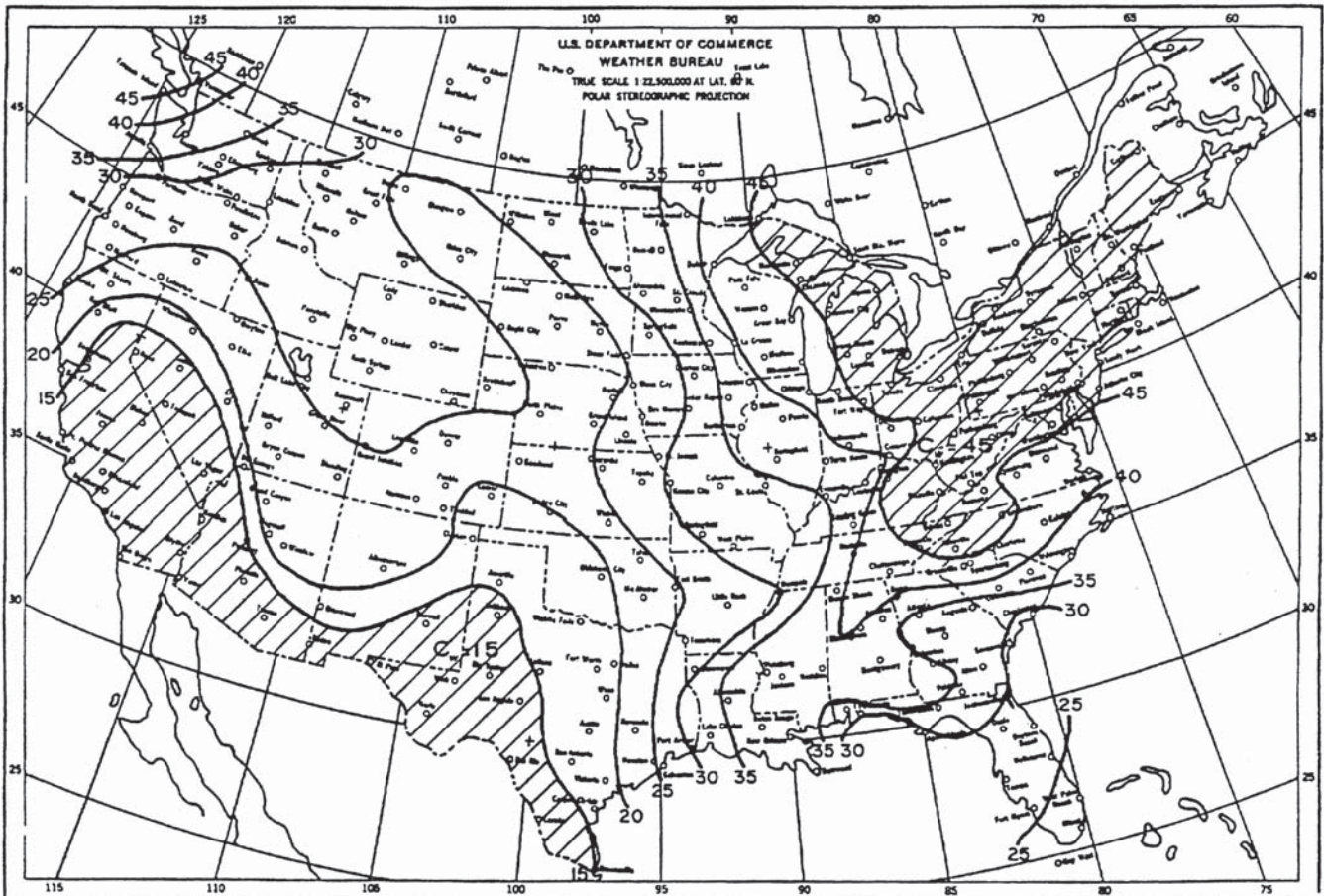

Figure 3

GEOGRAPHIC CONSIDERATIONS

BRAB utilized the Climatic rating (see Figure 4) of the locality to reflect the stability of the moisture content in an expansive soil. While there are other methods of accounting for the seasonal moisture change potential, this system has seemed to work well.



Climatic Ratings (C_w) for Continental United States

Figure 4

DESIGN LENGTH

Looking at the various loading conditions above and slabs in the field, it became apparent that the foundations were very sensitive to the changes at the edges. It was decided that a cantilever distance, (l_c) would be used as a basis for this design procedure to replace the L(1-C) utilized by BRAB. Figure 5 gives a cantilever design length for a given soil condition (PI) in a given climatic rating (C_w).

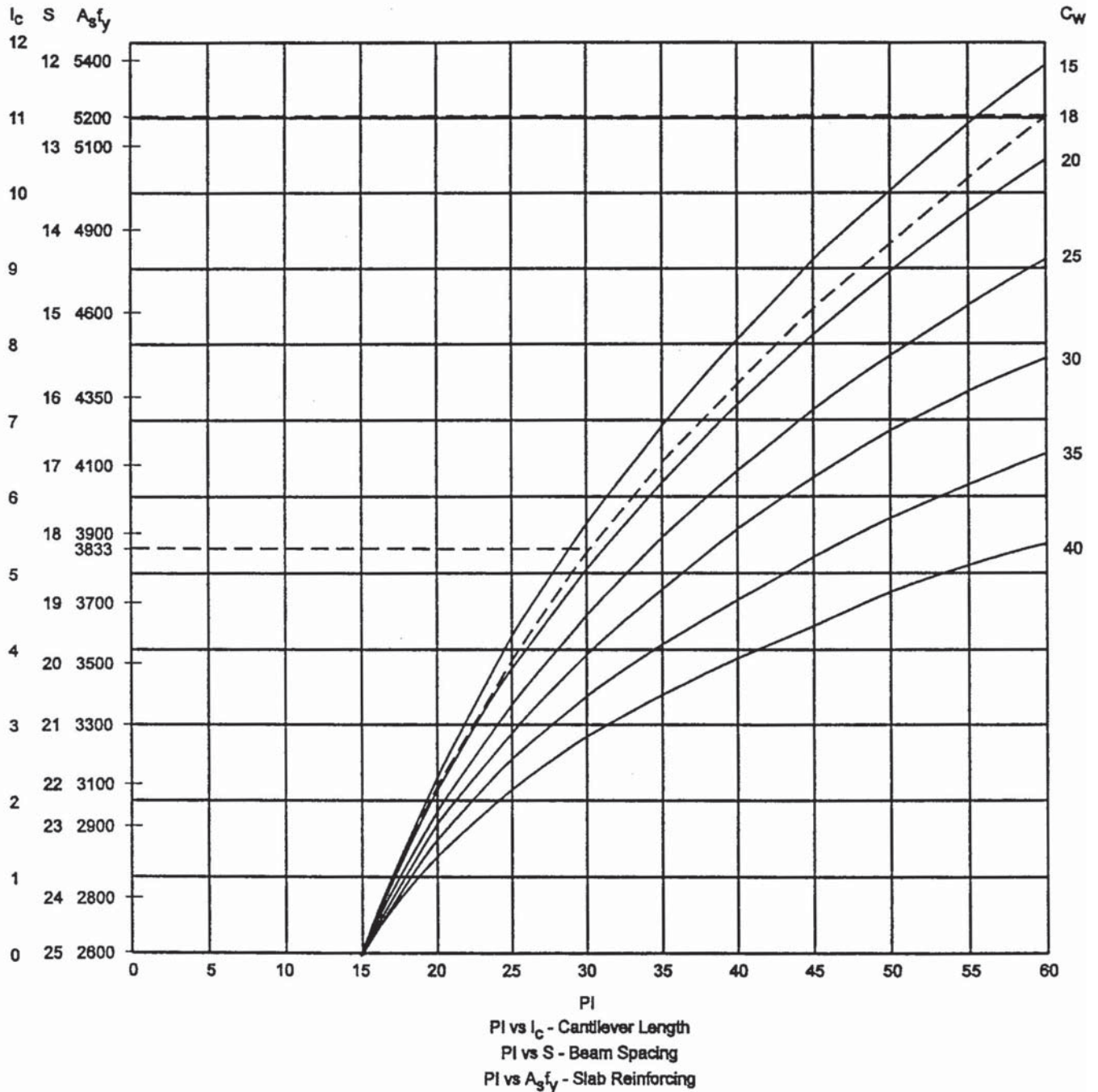

Figure 5

It seems apparent that the size of the foundation must also be considered. The values given in Figure 5 for the cantilever length are for large slabs. Figure 6 gives a modification coefficient which will adjust the cantilever length for smaller slabs depending on the slab size.

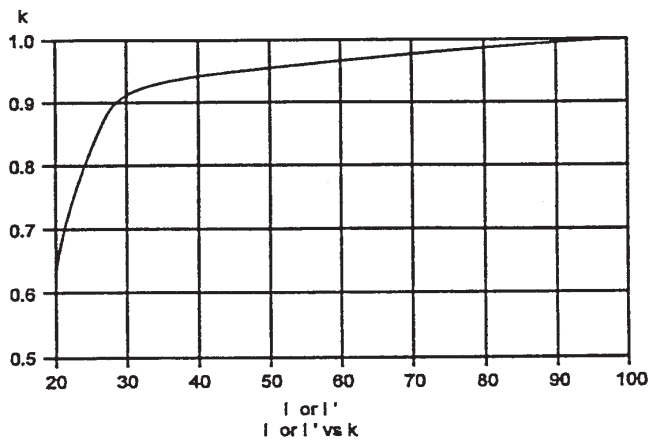

Figure 6

SOIL CONDITIONS

The design procedure shown in this report is based on the use of the “effective P.I.” (PI_D). It has long been known that the Plasticity Index (PI) of the soil can be used as an indicator of the Potential Volumetric Activity of a given soil. It has the added advantage of being a test which is familiar and inexpensive to perform.

Obviously, different soils have different PIs, and the PI may change with depth at any one location. To account for this, the design procedure first calculates an “equivalent” or “weighted” PI. It is necessary to use the weighing system shown in Figure

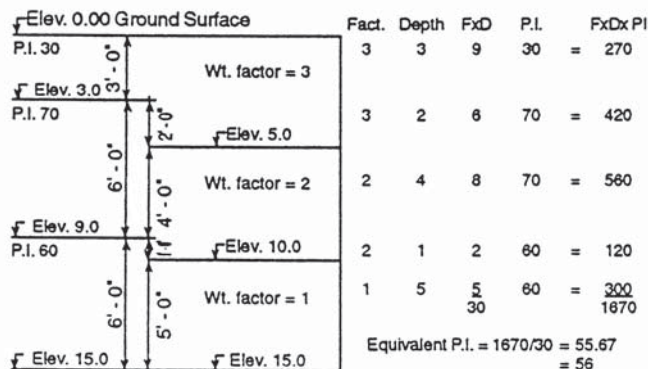

Figure 7

7 to be compatible with this design procedure. This weighing method gives more attention to the upper soils where the soil would have the opportunity for more activity, and reduces the activity potential with depth due to confining pressure and protection from seasonal moisture changes, etc. This is not the only way to weight this effect, but it has proved to be very satisfactory, and must be used for this procedure.

There are instances where this weighing system might give unconservative results. One would be where the underlying formations might contain sand stringers or are overlaid by porous sand which would provide quick, easy routes for water to reach any underlying or interbedded expansive clays.

A second case would be where highly expansive clays overlaid a rock formation. Using a zero (0) P.I. for these rock layers can reduce the equivalent P.I. excessively, making it appear to be a very stable site. It is recommended that to eliminate this problem, a minimum P.I. of 15 be used for any layers which have little or no P.I.

OTHER PARAMETERS OF CONCERN

Other factors to be considered are slope and degree of consolidation. Figures 8 and 9 present modification coefficients to be used with the “equivalent” PI to obtain the “effective” PI.

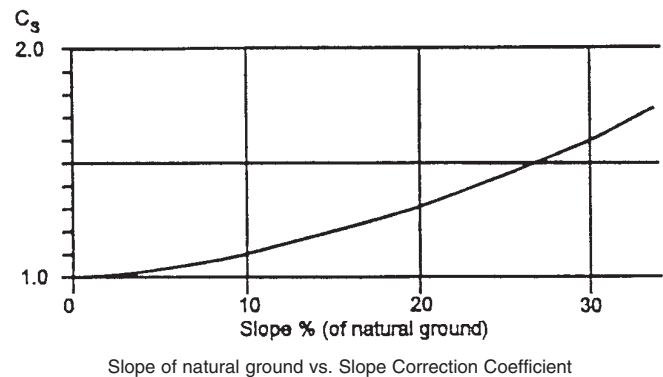
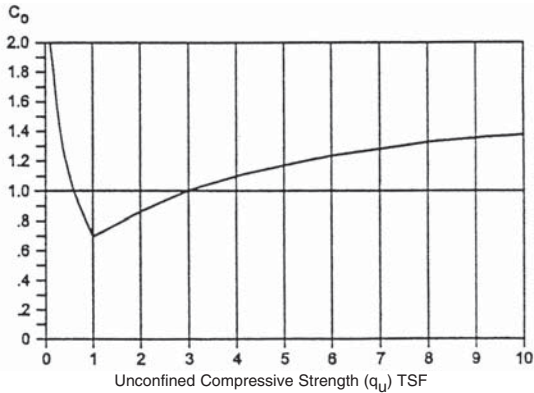

Figure 8



Unconfined Compressive Strength vs. Consolidation Correction Coefficient

Figure 9

The effective PI then is:

$$PI_o = \text{equivalent PI} \times C_5 \times C_o$$

Where: C_5 is the slope correction coefficient

C_o is the consolidation correction coefficient

As an example: assume -

- Equivalent (or weighted) PI = 30
- 10% ground slope C_5 (Fig. 8) = 1.1
- 6 TSF Unconfined C_o (Fig. 9) = 1.2
- $PI_o = 30 \times 1.1 \times 1.2 = 39.6$

Use an Effective Plasticity Index of 40 for design purposes

HOUSE GEOMETRY AND LOADS

It is best to calculate the total weight of house and foundation, but in lieu of that, or as a starting point it is possible to use the following for most conventional wood frame houses with no unusual features (tile roofs, floors, high masonry loads, etc).

- 1 story - 200 lb/sq.ft.
- 2 story - 275 lbs/sq.ft.
- 3 story - 350 lbs/sq.ft.

Most houses can be subdivided into several rectangles and each section then be analyzed and

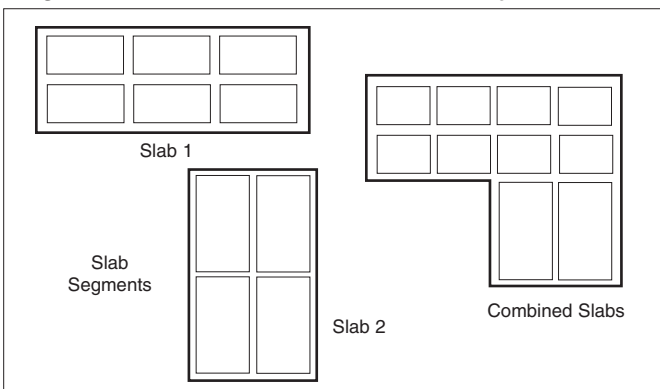

Figure 10

then overlaid as shown in Figure 10.

To begin the analysis the number of beams must be determined. Sometimes the geometry of the house will dictate the number of beams (N) required, sometimes the following equation will be used.

$$\frac{L'}{N} = S + 1 \quad \text{Where: } S = \text{Spacing ft (m) from Fig. 5}$$

$$L' = \text{width of slab, ft (m)}$$

$$d = \sqrt[3]{\frac{664 M I_C}{B}}$$

Where: d = Beam depth, in (mm)
 B = Sum of all widths, in (mm)
 M = Moment, kip-ft (N-m)
 I_C = Cantilever length, ft (m)

Once N is known, a very good first approximation of the depth of the beams can be determined by the equation:

Using these equations yields a starting point with N number of beams, b inches wide and d inches deep which will give a Moment of Inertia (in^4) adequate to limit deflection to the order of magnitude of 1/480. This deflection ratio is greater than the usual 1/360, but it usually furnishes beam depths which allow the reinforcing requirement to be two or three bars of moderate size top and bottom. Of course, if the reinforcing requirement is still extremely large, try deepening all or some of the beams to lessen the reinforcing required.

In calculating the actual I of the slab, the sections shown in Figure 11 should be used. As can be seen, the exterior beams can be deepened, or all beams can be deepened. It is felt that deeper exterior beams are more effective, but as long as the slab is kept symmetrical it does not seem to matter.

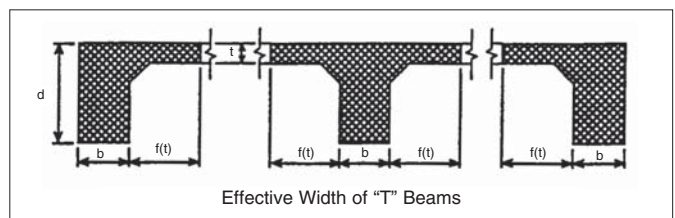

Figure 11

DESIGN CALCULATIONS

Now that the conditions have been defined, the following formulas can be used to calculate the moment, deflection and shear.

$$M = \frac{wL' (l_c)^2}{2}$$

$$\Delta = \frac{w (l_c)^4 L'}{4E_c I}$$

$$V = wL' l_c$$

Where: M = Moment + or -, kip-ft (N.m)

Δ = Deflection, in (mm)

V = Total shear, lbs (kg)

w = Unit weight, psf (kg/m²)

L' = Width of slab, ft (m)

l_c = Cantilever, (l_c k) ft (m)

E_c = Creep Modulus of Elasticity
of concrete, psi (MPa)

I = Moment of Inertia, in⁴ (mm⁴)

Naturally, these calculations will be performed in both the long and short directions.

TEMPERATURE AND SHRINKAGE REINFORCEMENT FOR CRACK CONTROL

The greatest number or reported complaints comes in the form of “cracked slabs”. Of course all concrete will crack. Shrinkage crack prevention has spawned a plethora of papers, documents and books. The engineering community understands shrinkage cracking for the most part, but the general public sees each crack as a “structural failure”. It is therefore very important to properly address the subject of minimum reinforcing to minimize shrinkage cracking and control crack widths.

The amount of reinforcing needed to control crack formation and width has been found to increase with the expansive potential of the site. Over the years greater need has developed to provide crack control to alleviate homeowners worries. When the

beam spacings are near those shown in Figure 5, the minimum reinforcing shown also in Figure 5 is usually adequate. While this will not prevent shrinkage cracking, it will provide adequate reinforcing to hold cracks to a minimum width during deflection. In the field, actual deflection is a function of the expansive nature of the soil, and the stiffness of the slab, so the soil and the beam spacing together influence the deflection. Since the beam spacing is based on the soil (PI) and climate (C_w), the minimum slab reinforcement can also be based on the same factors.

HIGH STRENGTH WELDED WIRE REINFORCEMENT

The use of welded wire reinforcement in concrete has a long history. For this procedure it is strongly recommended that sheets of welded wire, plain or deformed be used. This will provide positive placement in the slab. Welded wire reinforcement sheets can be placed with the same degree of accuracy as tied reinforcing bars. Sheets with larger wires and wider spacing are more readily available, and are easily positioned. The use of high strength welded wire has been accepted by code and some real economies can now be realized, not only in material costs, but in placement costs.

Use of WWR actually provides the engineer a large number of choices as can be seen by the comparison below. Assuming a moderate soil condition and climatic conditions noted, the reinforcing in Chart 1 would be acceptable.

On higher PI soils, it would seem advisable to go to heavier slab reinforcing, even though the stiffness of the slab should be such that cracks would not tend to open any more than at lower PIs. To see how that would look for a higher PI soil, compare Chart 1 to Chart 2.

COMPARISON OF REINFORCING (1)

PI=60 $C_w = 18$ $A_8 f_y = 3833$
Yield Stress Size Spacing** Style
 f_y A_8 (W-D)

60000	.064	W6.4	12"O.C.	12x12-W6.4xW6.4
65000	.059	W5.9	12"O.C.	12x12-W5.9xW5.9
70000	.055	W5.5	12"O.C.	12x12-W5.5xW5.5
75000	.051	W5.1	12"O.C.	12x12-W5.1xW5.1
80000	.048	W4.8	12"O.C.	12x12-W4.8xW4.8

Chart 1

COMPARISON OF REINFORCING (2)

PI=60 $C_w = 18$ $A_8 f_y = 5200$
Yield Stress Size* Spacing** Style
 f_y A_8 (W-D)

60000	.086	W8.6	12"O.C.	12x12-W8.6xW8.6
65000	.080	W8.0	12"O.C.	12x12-W8.0xW8.0
70000	.074	W7.4	12"O.C.	12x12-W7.4xW7.4
75000	.069	W6.9	12"O.C.	12x12-W6.9xW6.9
80000	.065	W6.5	12"O.C.	12x12-W6.5xW6.5

Chart 2

These values will approximate requirements of ACI 318, which allows for designs with yield strength up to 80,000 psi.

Use of the higher yield strengths will result in savings due to steel weight. Further savings can be realized by utilizing small edge wires closely spaced as shown in Figure 12. Savings will vary with specific areas, but some studies have shown that for each 5000 psi increase in f_y , about 8% in steel weight is reduced. The use of small edge wires closely spaced can save an additional 3% or more. Perhaps the greatest saving will be in placing where costs have been reported to be reduced 50% and more over other conventional steel reinforcing.

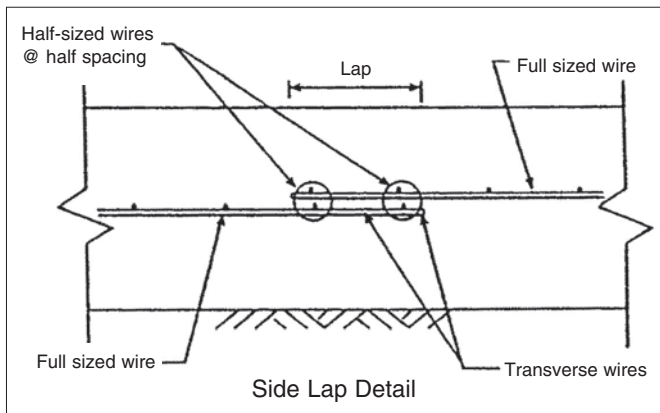

Figure 12

A DESIGN EXAMPLE

* W = plain wire, also can be prefix D for deformed wire.

** Wire spacings are available in 2" to 18" in either or both longitudinal and traverse directions. Contact individual welded wire producers for specific styles and spacings of WWR

This design example utilizes welded wire reinforcement for slab-on-ground foundations over soils with high PI values:

Given: PI = 60
 $C_w = 18$

$A_8 f_y = 5200$ lbs ($f_y = 75,000$ psi)
Slab Thickness = 4"

Then: $A_8 = \frac{0.0018 \times 60,000 \times (4 \times 12)}{75,000} = 0.069$ in.²/ft of concrete cross section

Check strength level required: $A_8 f_y = 75,000 \times 0.069 = 5175 = 5200$ OK

CONCLUSIONS

This design procedure, which has been in use about 37 years at this time, has produced satisfactory foundations for single family housing and small commercial applications. This update is meant to make it easier for the consultant to use by combining several tables into one (Fig 5). The Effective PI, and the Climatic Rating are all that need be known to obtain a cantilever length for design.

This paper is a condensation of more detailed work. Engineers may obtain copies of the original work by contacting the WRI. Copyright, Wire Reinforcement Institute Wire Reinforcement Institute 942 Main Street, Suite 300, Hartford, CT 06103 Phone: 800 552-4WRI(4974) • Fax: 860 808-3009 The Author Walter L. Snowden, P.E. Cedar Park, Texas

Phone: 512-331-6159

Fax: 512-331-6002