

**** CAUTION ****
OUTDATED INFORMATION
- USE AT YOUR OWN
DISCRETION

DESIGN DATA POURED GYPSUM ROOF DECKS

(GA 300-73)

**GYPSUM ROOF DECK
FOUNDATION**



**GYPSUM
ASSOCIATION**

201 North Wells Street, Chicago, Illinois 60606
1800 N. Highland Ave., Hollywood, Calif. 90028

TYPICAL CONSTRUCTION

BULB TEE SUBPURLINS
WELDED OR WOVEN WIRE MESH
REINFORCEMENT

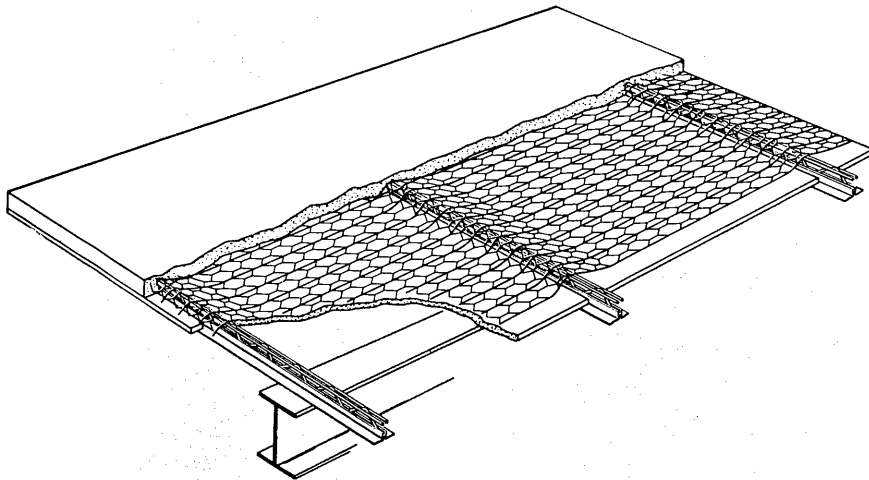
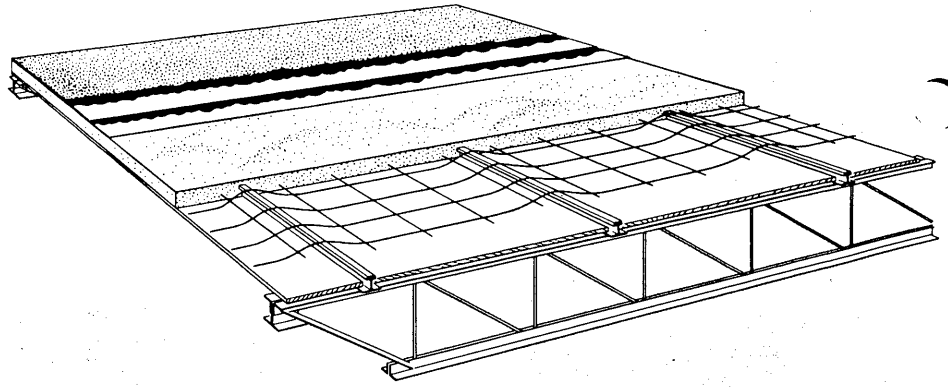

TRUSS TEE SUBPURLINS
WELDED OR WOVEN WIRE MESH
REINFORCEMENT

GYPSUM FORMBOARD
WELDED WIRE MESH
REINFORCEMENT

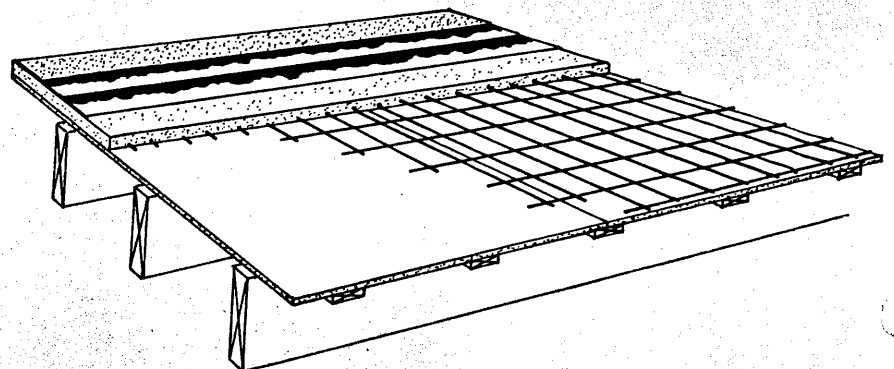

DESCRIPTION

A gypsum concrete roof deck consists of a reinforced gypsum concrete slab which has been poured on permanent forms that may or may not be supported by subpurlins. These lightweight systems offer low cost construction, two-hour fire ratings, and acoustical ceiling values. Quick-setting gypsum concrete is poured in place over galvanized reinforcing mesh and formboards supported by steel subpurlins. When completed, the deck will provide a structurally strong, monolithic roof deck ready for immediate roofing. These high-strength systems meet normal live and dead load requirements for roofs and, in addition, provide high safety factors for vertical loads and seismic forces.

Gypsum concrete roof decks have proved themselves for over 50 years to be ideally suited for use over steel roof framing on flat or nearly flat roofs. They are readily adapted to low-pitched or geometric roof constructions where roof framing is steel, concrete, or wood.

GYPSUM CONCRETE

Gypsum concrete is a factory controlled mixture of gypsum and wood chips, shavings or mineral aggregate. It requires only the addition of water at the job site. Gypsum concrete is poured in place over permanent formboards to an average thickness of not less than 2 inches. Once in place, it forms a lightweight roof deck having many advantages over competitive systems.

STEEL SUBPURLINS

Steel subpurlins (bulb tees, truss tees, or others) are welded transversely to the primary framing and support the formboards and the gypsum concrete roof slab. They anchor the deck against uplift forces, restrict deck movement due to temperature changes, and provide lateral bracing for the main roof purlins. Subpurlins vary in size, weight and shape and are selected on the basis of the span between main purlins and the required total safe load of the deck.

FORMBOARDS

The several types of permanent formboards are described on page 10. Formboards are nonstructural components of the roof deck and usually are not considered in the load carrying capacity of the slab. They serve as a form and remain in place to provide a functional underside of the roof deck. Various types of formboards are available to provide fire resistance, light reflection, insulation, sound absorption or economy as required.

REINFORCING MESH

Two types of "reinforcing fabric" are generally recommended as a reinforcement for gypsum concrete. They are galvanized woven wire mesh or galvanized welded wire mesh. The wire mesh is laid or placed in the gypsum slab in long continual lengths. Once the deck has been poured, the reinforcement mesh will provide added strength and shear resistance to the deck.

Other types of reinforcing mesh may be used if they provide adequate bond and corrosion resistance and if their effective cross-sectional area is not less than 0.026 sq. in. per foot of slab width.

FUNCTION - UTILITY

LIGHT WEIGHT

Gypsum concrete roof slabs weigh approximately one third as much as stone concrete. Including the gypsum slab, formboard, reinforcing and subpurlins, the total dry dead load does not normally exceed 11.5 lbs per sq ft. This low dead load allows design and use of a lighter structural steel frame.

STRENGTH

Gypsum concrete forms a slab of high compressive strength with a hard surface. Gypsum concrete decks built to specifications and tested at an independent laboratory supported uniformly distributed loads in excess of 450 lbs per sq ft when wet and over 700 lbs per sq ft when dry.

APPEARANCE

The variety of formboard available for use with gypsum concrete roof decks provides a wide choice of functional and attractive under surfaces. They are ideal for almost every type of roof deck need, including churches, gyms, schools, warehouses, apartment buildings and manufacturing plants. Gypsum formboards can be decorated to provide color when desired (see page 4).

LOW COST

The ease of construction plus the structural rigidity, fire protection, functional utility, and light weight of gypsum concrete help keep over-all construction costs to a minimum.

DURABLE

Proven in use for over half a century, gypsum concrete is chemically inert and will not rot, burn or decay.

ADAPTABILITY

Gypsum concrete roof decks can be installed on virtually any roof shape, size, or configuration (warped, sloped, sawtooth, curved or pitched). Primary framing may be wood, steel or concrete. Alterations can be readily made at any time.

When gypsum fill is sloped to an inside drain, 1/16" to 1/8" per foot slope drop is considered to result in the most economical and most satisfactory drainage. Drainage slope systems, however, are not structural roof decks and the gypsum manufacturer should be consulted for ventilation and expansion and construction details.

NONCOMBUSTIBLE - INSURANCE

Gypsum concrete roof decks poured over gypsum asbestos or glass fiber formboards are classified as *noncombustible*. These decks are given very low insurance rates since all components are noncombustible.

When wood fiber formboards are used the classification is still noncombustible but generally insurance deficiency penalties are imposed.

NONCOMBUSTIBLE — INSURANCE (continued)

Regardless of the formboard used a gypsum concrete roof deck provides substantial protection against ignition of combustibles above the deck.

FIRE RESISTANCE

Gypsum concrete slabs 2 inches thick on gypsum and mineral fiber formboards qualified for 1 and 2 hour fire resistance ratings in tests conducted in compliance with ASTM E 119 at a nationally recognized laboratory. (See page 5 for details and reference test numbers.)

SOUND CONTROL

Recent tests conducted by a nationally recognized independent acoustical laboratory show that the combination of 2 inches of gypsum concrete over 1/2 inch gypsum formboard will result in a 46 STC rating. When 1 inch glass fiber formboard is used with 2 inches of gypsum concrete, an NRC range of .75 to .85 can be achieved.

INSULATING

Gypsum concrete roof deck systems offer a wide choice of construction assemblies to meet the insulation requirements of any building. Insulation characteristics can be incorporated in the formboard (see page 9).

SEISMIC

Gypsum roof decks have a high ability to resist lateral forces. Based upon extensive test data, horizontal diaphragm shear values in excess of 1100 pounds per lineal foot are allowed by each of the following regulatory jurisdictions:

- International Conference of Building Officials—
Uniform Building Code
- City of Los Angeles—
General Approvals 22107 and 23267
- City of San Francisco—*Approval 400G10.1*
- Departments of the Army, The Navy, and The Air Force—
Seismic Design for Buildings (Tri-Service Manual)

Each approval gives criteria for computing allowable shear and includes a table listing allowable values for several conventional gypsum deck assemblies. Each approval also gives values for bolts, dowels, or trussed tees when used for shear transfer to vertical elements.

The Pacific Fire Rating Bureau, earthquake insurance rating office, and the State of California, Office of Architecture and Construction, also allow gypsum roof deck assemblies to be used as horizontal diaphragms. Typical details of deck construction and methods of shear transfer to vertical elements are shown on page 13. Specific design requirements should be obtained from the applicable approval governing each project.

SPEED OF ERECTION

Gypsum concrete sets fast. The roof slab may be used as a working surface within 30 minutes after pouring. Construction goes fast with an average rate of 10,000 to 30,000 sq. ft. per day. Decks can be poured during the coldest weather in which men normally work.

INSTALLATION SERVICE

Gypsum concrete roof deck contractors are trained and equipped to provide high quality construction on schedule. Accurate shop drawings can be provided by the roof deck contractor. A specialist in roof deck construction, the gypsum roof deck contractor is skilled in coordinating his work with other trades on the job.

RECOMMENDATIONS

UPLIFT RESISTANCE

Uplift forces are often created when high winds or hurricanes create a low pressure area above a roof deck. For design purposes, the total dead load of the roof deck is considered part of the total resistance to uplift forces. Gypsum concrete roof decks resist this uplift action by four times the normal requirement (35 lbs. per sq. ft.) when constructed with subpurlins welded to the primary framing. This is one of the few roof deck systems which has passed the UL Class 90 uplift test. Roof decks not using tee subpurlins welded to the steel framing or roof decks over bar joists without subpurlins should have supplementary anchorage.

EXPANSION OR CONTRACTION

The welding of the subpurlins to the structural framing effectively limits slab movement perpendicular to the subpurlins in gypsum concrete constructions. The reinforcing mesh resists movement in the other direction, parallel to the subpurlins. Coefficients of expansion of gypsum concrete average 0.0000085 in. per in. per °F.

However, special provisions for relief of expansion and contraction should be considered for all poured roof decks of substantial area. Some guideposts are:

1. Wherever an expansion joint occurs in the main structure, one should be provided for the deck.
2. Wings of "L", "U" or "T" shaped buildings should be separated from main building with expansion joints.
3. Where direction of the structural framing changes, relief should be provided.
4. Long narrow buildings should have expansion joints through the structural frame and the roof deck (minimum 200 ft. o.c.).
5. At parapet walls, stacks, etc., expansion strips should be placed between roof slab and wall.

DRYING AND VENTILATING

After the gypsum concrete is poured adequate ventilation is recommended to remove the excess moisture introduced into the building not only by the slab, but also by concrete floors, masonry, plastering and other similar construction work. Adequate provisions should be made to permanently vent any enclosed space between the ceiling and the slab.

DECORATING

The underside of the poured gypsum deck is usually not decorated because the formboard provides a presentable surface. If painting is desired, it should be deferred until the formboard and the slab are dry.

DECORATING (continued)

The paint specified and used should be a non-sealing, non-bridging type and should be fortified with adequate mildew inhibitor.

CEILINGS

Suspended ceilings should preferably be hung from the primary framing itself. They can be hung from the subpurlins only if a design check is made to determine whether the added weight of the ceiling will not cause more subpurlin deflection than that allowable for the roof deck or ceiling design, or more stress than allowable by code or subpurlin design. In no case should hangers be fastened into or through the poured gypsum concrete slab or the formboards. Similar precautions should be followed for any suspended units such as heaters, light troffers, and piping.

ROOFING

Application of the roof membrane should follow the pouring of the deck as soon as possible (within 48 hours). The general contractor, roof deck contractor and roofing contractor should coordinate the roof membrane and roof deck construction to accomplish this.

Unless otherwise specified by the roofing manufacturer, the first course should be a minimum 40 lb. coated base sheet applied with the long dimension parallel to the subpurlins and laid dry. Nail in a pattern recommended by the manufacturer of the roofing material.

The nailing procedure will provide immediate and positive attachment of the roof membrane to the gypsum concrete deck, isolate the roof membrane from localized deck movement, and allow for lateral dissipation of water vapor pressure. Succeeding roofing felts are to be applied in accord-

ance with the manufacturer's specifications.

Where roof insulation is required, a vapor barrier consisting of a minimum 40 lb. coated base sheet should be applied dry to the deck and nailed using a proper fastener. The roof insulation shall be applied next, followed by the roof membrane in accordance with the roofing material manufacturer's specifications.

Perimeter edges should be provided with wood nailing strips.

LIMITATIONS

EXCESSIVE MOISTURE OR TEMPERATURE

Poured gypsum concrete, when exposed to unusually high and continuous humidity or intermittent or extended high temperatures, may not be satisfactory. The gypsum concrete manufacturer should be consulted in these cases for special recommendations.

ACIDS

Acid fumes generally do not affect gypsum concrete any more adversely than they do other constructions. If acid fumes are contemplated, the manufacturer of the gypsum concrete should be consulted for special recommendations.

HEAVY LOADS

Heavy concentrated loads such as water tanks, large fan bases, and cooling towers, should be supported independently of the roof deck by the walls or by primary framing members.

All trades using the deck as a work platform should exercise caution so as not to exceed the design capabilities of the deck.

NAIL HOLDING POWER

Description of Nail	48 lb. min. density Gypsum Concrete			38 lb. min. density Gypsum Concrete		
	removal - 1 day	removal - 7 days	removal - slab dry	removal - 1 day	removal - 7 days	removal - slab dry
1½" - plain finish (1¼" penetration)	67 ⁽¹⁾	77	136	60 ⁽¹⁾	67	141

(Resistance to direct pull, in pounds, for plain finished nails placed 24 hours after pouring slab).

1. Provides min. 40 lbs. immediate holding power required by roofing manufacturers.

- Notes:
- A. Tests were conducted by a gypsum manufacturer's research center. Nails were removed hydraulically from poured gypsum slabs with 2" minimum thickness.
 - B. Dry density of gypsum concrete was 48 lbs. per cu. ft. Dry density of lightweight gypsum concrete was 38 lbs. per cu. ft. Nail holding power of fill decreases at densities less than those cited.
 - C. Nails must be driven into wet slabs as soon as possible because most nails depend on rusting to increase holding power.
 - D. Any approved fastener which will withstand a 40 lb. immediate withdrawal resistance may be used.

DESIGN DATA



On the next four pages are shown the physical properties of the components of Gypsum Concrete Roof Decks as well as properties of the composite deck.

The safe total loads shown on page 7-9 are based on the properties of the subpurlin without consideration for the structural contribution of the gypsum slab or reinforcement. This contribution is considerable, thus reflecting a probable higher factor of safety.

These tables are based on the subpurlins being continuous (3 spans or more— $M = \frac{WL}{11.7}$). Conversion factors are shown to enable selection of the appropriate subpurlin when it is a simple beam ($M = \frac{WL}{8}$) or when continuous over two spans ($M = \frac{WL}{8.9}$).

These safe total loads are based on the total load carrying capacity of the subpurlin, live and dead load uniformly distributed. When other loads such as suspended ceilings are supported by the subpurlins their selection will be influenced by these additional loads.

To determine the maximum eave overhang of a subpurlin, a safe total load of 45 lbs. per sq. ft. is generally assumed and length of overhang is calculated by the formula $M = \frac{wL^2}{2}$. However the selection of the subpurlin will be affected by the location and weight of wood nailers, angles, gutters or soffits supported by the subpurlins (treat as point loads-cantilever beams).

fs = fiber stress (psi)

S = section modulus

I = moment inertia

W = total load

d = deflection

E = modulus elasticity (30 x 10⁶ psi for steel)

w = uniform load

L = length of span

1. Maximum allowable bending moment (M)

$$M = fs \times S$$

2. Safe uniform load (w)

$$w = \frac{11M}{L^2} \quad (\text{continuous or 3 span conditions})$$

$$w = \frac{8M}{L^2} \quad (\text{single or two span conditions})$$

$$w = \frac{2M}{L^2} \quad (\text{eave overhang})$$

3. Maximum deflection (assuming uniform loading)

$$d = .006884 \frac{wL^4}{EI} \quad (\text{continuous or three span conditions})$$

$$d = .005416 \frac{wL^4}{EI} \quad (\text{two span conditions})$$

$$d = .013020 \frac{wL^4}{EI} \quad (\text{single span conditions})$$

$$d = \frac{wL^4}{8EI} \quad (\text{true cantilever overhang only})$$

$$d = \frac{wa}{24EI} (4a^2L - L^3 + 3a^3) \quad (\text{beam overhang, one interior span only.})$$

L = length of interior span and a = length of overhang

Characteristics, properties or performance of materials or systems herein described are based on data obtained under controlled test conditions. The Gypsum Association and the member companies make no warranties or other representations as to their characteristics, properties or performance under any variation from such conditions in actual construction. Test conditions details will be furnished by the Gypsum Association or the appropriate member company on request. In cases where industry practices have changed so that standard descriptions no longer accurately describe products used in tests, the standard descriptions used in this manual are those that are deemed to most closely describe the product. This manual is intended to serve only as a guide. For complete information on systems and component parts used in tests the test report and testing agency should be consulted.

BULB TEE SUBPURLIN PROPERTIES AND DIMENSIONS

	Size	112	158	168	178	218	258
	Weight Per Foot, lbs.	1.40	1.47	1.65	1.95	3.00	4.67
	Moment of Inertia, in. ⁴ (1)	0.123	0.170	0.286	0.349	0.598	1.388
	Section Modulus, in. ³ (S)	0.126	0.172	0.245	0.318	0.520	1.057
	Maximum Eave Overhang See Note 7, below.	2' 2"	2' 9"	3' 4"	3' 11"	4' 10"	6' 10"
	B-2 Inches	3/8	3/8	7/16	9/16	11/16	5/16
	B Inches	1 1/2	1 9/16	1 1/2	1 5/8	2 1/8	2 1/4
	D Inches	1 1/2	1 5/8	2	2	2 1/8	2 5/8
	B-1 Inches	0.109	0.121	0.109	0.109	0.125	0.140
	D-1 Inches	0.109	0.121	0.109	0.109	0.140	0.140
	D-2 Inches	0.522	0.635	0.832	0.901	0.975	1.312
	D-3 Inches	0.978	0.990	1.168	1.099	1.150	1.312
	Design Stress	39,600 PSI					33,000 PSI
Min. Yield Point	60,000 PSI					50,000 PSI	
Min. Tensile Stress	80,000 PSI					80,000 PSI	

NOTE: All properties shown are taken from data furnished by manufacturers and are published for information only. The Gypsum Association assumes no responsibility for the accuracy thereof.

NOTES

- Total safe loads are based on design stresses of 39,600 or 33,000 psi for steel bulb tees acting alone. (see table below).
- Deflection loads are based on the bulb tee acting with the slab in composite action and consider live load deflection only.
- Where 0 loads are shown the *dead load* of the slab during erection will cause a deflection of the tee greater than L/240.
- To determine loads for 20,000 psi design stress, multiply safe loads by 0.505 for 112, 158, 168LW and 178LW subpurlins. Multiply by 0.606 for 218 and 258 subpurlins.
- To determine loads for tee spacing of 24" o.c. multiply safe loads by 1.325.
- To determine loads for def/360 multiply def/240 load by 0.67. For def/180 load multiply def/240 by 1.325.
- The eave overhang values shown are for a total load of 45 pounds per square foot. Bending moment $M = \frac{1}{2} wL^2$ spaced as indicated based on manufacturer's tee with minimum section modulus.

Caution must be used in selecting sub-purlins because eave overhangs and soffits are supported by sub-purlins. Where those conditions are noted, the maximum eave overhang for a given sub-purlin must be checked by calculating the maximum moment developed, since loads applied beyond or at the end of the sub-purlin greatly increase the total moment. Deflection should also be taken into account on overhang designs.

$$\text{Safe uniform load: } w = \frac{2M}{L^2} \text{ (eave overhang)}$$

$$\text{Max. Bending Moment: } M = fsS$$

$$\text{Deflection eave overhang (assume uniform loading): } d = \frac{wL^4}{8EI}$$

TOTAL SAFE UNIFORM LOAD IN POUNDS PER SQUARE FOOT (CONTINUOUS OR THREE-SPAN CONDITION)

SUBPURLIN	SPAN													
	5'-0"	5'-6"	6'-0"	6'-6"	7'-0"	7'-6"	8'-0"	8'-6"	9'-0"	9'-6"	10'-0"	10'-6"	11'-0"	
112	60	49	43											
158	90	74	62	53	46									
168		107	90	77	66	58	51							
178			115	98	84	73	64	57	51					
218							91	80	72	65	58	53	48	
258												107	97	

NOTE: For spans greater than 11' 0", consult the manufacturer for recommendations.

DEFLECTION TABLES

Deflection Limits	1 — SPAN				2 — SPAN			3 — SPAN		
	Live Load	20 PSF	30 PSF	40 PSF	20 PSF	30 PSF	40 PSF	20 PSF	30 PSF	40 PSF
	Subpurlin				Load Governs					
1/180 of span	112	5'-8"	4'-11"	4'-6"	"	6'-7"	6'-0"	7'-0"	6'-1"	5'-7"
	158	6'-6"	5'-8"	5'-1"	"	7'-7"	6'-11"	8'-0"	7'-0"	6'-4"
	168	7'-7"	6'-8"	6'-0"	"	8'-11"	8'-1"	9'-5"	8'-2"	7'-5"
	178	8'-1"	7'-0"	6'-5"	"	9'-5"	8'-7"	10'-0"	8'-8'	7'-11"
	218	9'-9"	8'-6"	7'-9"	"	11'-5"	10'-4"	12'-0"	10'-6"	9'-7"
	258	12'-2"	11'-1"	10'-0"	"	Load governs	13'-5"	15'-8"	14'-1"	12'-10"
1/240 of span	112	5'-1"	4'-6"	4'-1"	6'-11"	6'-0"	5'-5"	6'-4"	5'-6"	5'-0"
	158	5'-10"	5'-1"	4'-8"	8'-1"	6'-11"	6'-2"	7'-3"	6'-4"	5'-9"
	168	6'-11"	6'-1"	5'-6"	9'-3"	8'-1"	7'-4"	8'-6"	7'-5"	6'-9"
	178	7'-4"	6'-5"	5'-9"	9'-10"	8'-7"	7'-10"	9'-0"	7'-11"	7'-2"
	218	8'-10"	7'-8"	7'-0"	11'-10"	10'-4"	9'-5"	10'-11"	9'-6"	8'-8"
	258	11'-1"	9'-9"	9'-1"	15'-0"	13'-3"	12'-2"	14'-3"	12'-10"	11'-7"

TRUSSED-TEE SUBPURLIN PROPERTIES AND DIMENSIONS

SPECIFICATIONS AND DESIGN PROPERTIES												
	Top Chord and Truss	Bottom Chord										
Yield f_y psi	80,000	50,000										
Design f_d psi	48,000	30,000										
Size No.	5-6-17-1 3/4	5-6-17-2	4-5-17-2	2-5-17-2	1-5-17-2	2-3-17-2 1/2	1-3-17-2 1/2	00-5-15-2	00-3-15-2 1/2	000-5-14-2	000-3-14-2 1/2	
Gauge of Chord Wires, No.	5	5	4	2	1	2	1	00	00	000	000	
In. Dia of Chord Wires	.2070	.2070	.2253	.2625	.2830	.2625	.2830	.3310	.3310	.3625	.3625	
In. ² Area of 2 Chord Wires	.0673	.0673	.0797	.1082	.1258	.1082	.1258	.1720	.1720	.2064	.2064	
Gauge of Truss Wires, No.	6	6	5	5	5	3	3	5	3	5	3	
In. Dia of Truss Wire	.1920	.1920	.2070	.2070	.2070	.2437	.2437	.2070	.2437	.2070	.2437	
In. ² Area of Truss Wire	.0289	.0289	.0337	.0337	.0337	.0466	.0466	.0337	.0466	.0337	.0466	
Gauge of Chord Angles, No.	17	17	17	17	17	17	17	15	15	14	14	
In. Thickness of Chord Angles	.0538	.0538	.0538	.0538	.0538	.0538	.0538	.0673	.0673	.0747	.0747	
In. ² Area of Chord Angles	.1883	.1883	.1883	.1883	.1883	.1883	.1883	.2355	.2355	.2615	.2615	
d_1 Inches	.1726	.1726	.1726	.1726	.1726	.1726	.1726	.1834	.1834	.1870	.1870	
d_2 Inches	.3880	.4537	.5098	.6186	.6752	.8010	.8754	.6968	.9097	.7198	.9404	
d_3 Inches	1.0859	1.2702	1.2049	1.0775	1.0107	1.3951	1.3105	.9543	1.2432	.9119	1.1913	
d_4 Inches	.1035	.1035	.1127	.1313	.1415	.1313	.1415	.1655	.1655	.1813	.1813	
E Inches	.6875	.6875	.6875	.6875	.6875	.6875	.6875	.6875	.6875	.6875	.6875	
D Inches	1 3/4	2	2	2	2	2 1/2	2 1/2	2	2 1/2	2	2 1/2	
C Inches	2 1/8	2 1/8	2 1/8	2 1/8	2 1/8	2 1/8	2 1/8	2 1/8	2 1/8	2 1/8	2 1/8	
B Inches	9/16	9/16	19/32	21/32	23/32	23/32	3/4	13/16	27/32	7/8	29/32	
A Inches	3 1/2	3 1/2	3 1/2	3 1/2	3 1/2	4 1/2	4 1/2	3 1/2	4 1/2	3 1/2	4 1/2	
Resisting Moments, inch lbs.	4,776	5,583	6,578	8,832	9,523	11,429	12,333	11,665	15,198	12,801	16,722	
Lbs. Per Lineal Ft. of Subpurlin	1.03	1.03	1.10	1.20	1.26	1.27	1.32	1.58	1.64	1.78	1.85	

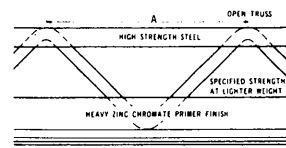
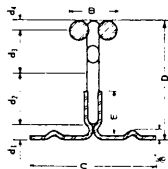

TRUSS TEE SIZE RECOMMENDATIONS
LIVE LOAD DEFLECTION 1/240 OR LESS
POUNDS PER SQUARE FOOT TOTAL LOADS FOR CONTINUOUS OR 3-SPAN CONDITIONS

(For decks with 2" Gypsum Concrete over: 1/2" Gypsum Formboard, 1" and 1 1/2" Formboards)

SUBPURLIN STYLE	Span Length											
	5'-0"	5'-6"	6'-0"	6'-6"	6'-8"	7'-0"	7'-6"	8'-0"	8'-6"	9'-0"	9'-6"	10'-0"
5-6-17-1 3/4	65	54	45									
5-6-17-2	76	63	53	45	43	39						
4-5-17-2	89	74	62	53	50	45	40					
2-5-17-2	119	98	82	70	67	60	53	46				
1-5-17-2	129	107	90	76	73	66	57	50	45	40		
2-3-17-2 1/2			106	91	86	78	68	60	53	47		
1-3-17-2 1/2			116	99	94	85	74	65	58	52	46	42
00-5-15-2			110	94	89	81	70	62	55	49	44	40
00-3-15-2 1/2						106	92	81	71	64	57	52
000-5-14-2						89	77	68	60	54	48	43
000-3-14-2 1/2							101	89	78	70	63	57

Notes: A. Loads are based on subpurlin spacing of 32 3/4" O.C. For 24 3/4" spacing multiply loads by 1.32. For two span conditions multiply loads by 0.8. For single span conditions multiply loads by 0.72.

B. No load value above exceeds the maximum stress of the subpurlin acting by itself. Live load deflection is based on the composite section of the roof deck system. Because of their design, Keydeck Truss Tee Subpurlins imbedded in the deck system form a composite section which reacts as a beam under load utilizing the compressive strength of the other components in the system as established by tests.

DATA ON COMPONENT PARTS FOR GYPSUM CONCRETE ROOF DECKS

DESIGN WEIGHT AND INSULATION—"U" VALUES (1)

Deck System	Dry Deck Weight psf (3)	Wood or Mineral Fiber Roof Insul. Thick-in.	"U" Values-Exposed Formboard	"U" Values-5/8" Mineral Panels or Tile (4)			"U" Values 3/4" Mineral Tile (4)		
				No. Added Insul.	Plus 2" Wool Batts	Plus 3" Wool Batts	"F"	"db"(1)	"db"(2)
2" Gypsum Concrete 1/2" Gypsum Formboard	11	0	.36	.18	.08	.06	.17	.13	.07
		1/2	.24	.15	.07	.06	.14	.11	.06
		1	.18	.12	.06	.05	.12	.09	.06
		1 1/2	.14	.10	.06	.05	.10	.08	.05
2" Gypsum Concrete 1" Mineral Fiber Formboard	10	0	.16	.11	.06	.05	.11	.09	.05
		1/2	.14	.10	.06	.05	.10	.08	.05
		1	.11	.09	.05	.04	.09	.07	.05
2" Gypsum Concrete 1" Acoustical Formboard	10	0	.22	—	—	—	—	—	—
		1/2	.17	—	—	—	—	—	—
		1	.14	—	—	—	—	—	—
2 1/4" Gypsum Concrete 1/4" Asbestos-Cement Formboard	12	0	.40	—	—	—	—	—	—
		1/2	.26	—	—	—	—	—	—
		1	.19	—	—	—	—	—	—
		1 1/2	.15	—	—	—	—	—	—
2" Lightweight Gypsum Concrete 1/2" Gypsum Formboard	8	0	.30	.17	.07	.06	.16	.12	.06
		1/2	.21	.14	.07	.05	.13	.10	.06
		1	.16	.11	.06	.05	.11	.09	.05
		1 1/2	.13	.10	.06	.05	.10	.08	.05
2" Lightweight Gypsum Concrete 1" Mineral Formboard	8	0	.15	.11	.06	.05	.10	.09	.05
		1/2	.13	.09	.06	.05	.09	.08	.05
		1	.11	.08	.05	.04	.08	.07	.05
2" Lightweight Gypsum Concrete 1" Insulation Formboard	8	0	.18	.12	.06	.05	.12	.09	.06
		1/2	.15	.10	.06	.05	.10	.08	.05
		1	.12	.09	.06	.05	.09	.08	.05

(1) Btu./sq. ft./hr./deg. F. temp. diff. (includes built-up roofing; for winter conditions — heat flow up, except as noted (2) Summer conditions — heat flow down (3) Weight of subpurlin or

roofing is not included. Gypsum concrete density is 50 lb. per cu. ft. Lightweight gypsum concrete density is 39 lb. per cu. ft. (4) Mechanically suspended.

"U" VALUES FOR GLASS FIBER FORMBOARD:

Thickness	3/4"	1"	1 1/4"	1 1/2"	1 3/4"	2"
Winter "U" Value	.18	.15	.13	.12	.10	.09

2" poured gypsum decks over exposed glass formboard. Show various winter condition "U" values in BTU/(hr.) (sq. ft.) (deg. F.) with varying thicknesses of formboard.

FORMBOARD CHARACTERISTICS

Formboard	Gypsum Formboard	Insulation Formboard	Mineral Fiber Formboard	Asbestos Formboard	Fiber Glass Formboard
Thickness	1/2"	1"	3/4" to 2"	1/4"	3/4" to 2"
Width	32" or 48" (3)	32" 36" 48" (3) only	32" and 24"	32"	32" and 24"
Length	up to 12' max.	up to 12' max	up to 6'8" max.	48"	48"
Flame Spread	15-20(1)	(3)	0-5(2)	0-5	10-15
Noise Reduction Coefficient	—	(mill primed) .25	.40-.75	—	.70 - .85
Light Reflection Coefficient	66%	(mill primed) 78%	—	40%	40% to 60%
Specification Compliance	ASTM C-318-55 C-472-64	Federal Spec. SS-L-30c Type V	ASTM 208-55 Class A	Federal Spec. (4) SS-S-118a Class 25 (Incombustible)	Federal Spec. SS 118 a Class 25 (Incombustible)

(1) Flame spread ratings determined by ASTM E84, "Methods of Test for Surface Burning Characteristics of Burning Construction."
 (2) Insulation formboard gypsum decks are usually classed as noncombustible with a deficiency penalty when combustible form-

board is used. (3) 48" wide formboard may be used with light subpurlin sections only if main supporting steel is spaced not to exceed 36" o.c. (4) Also meets Federal Spec. HH-1-564, Type II.

DETAILS

POURED GYPSUM ROOF DECKS

APPLICATION OVER BEAMS AND BAR JOISTS

EAVES

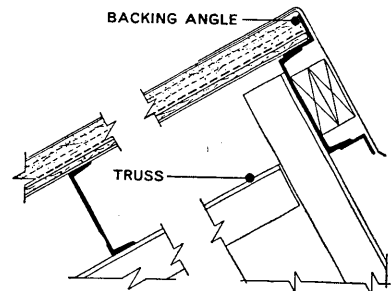
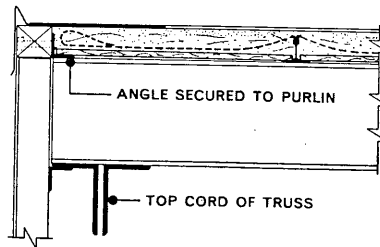
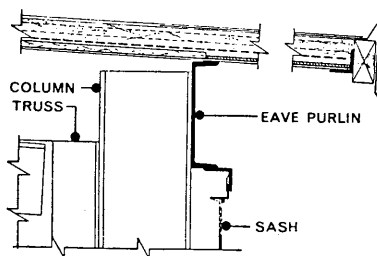

EAVE & GABLE OVERHANG (OVERHANG BASED ON 45° TOTAL LOAD)

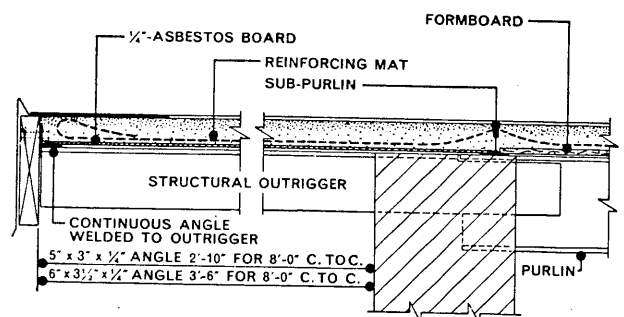
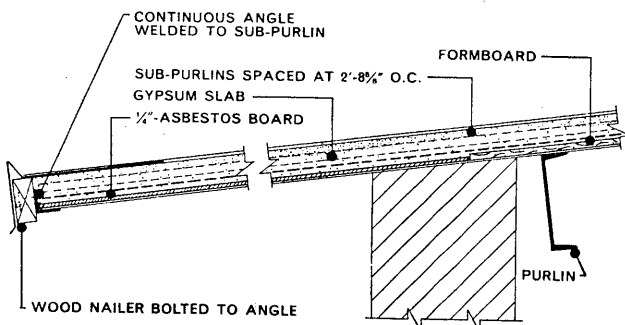

APPLICATION OVER WOOD FRAMING

EAVE VENTING

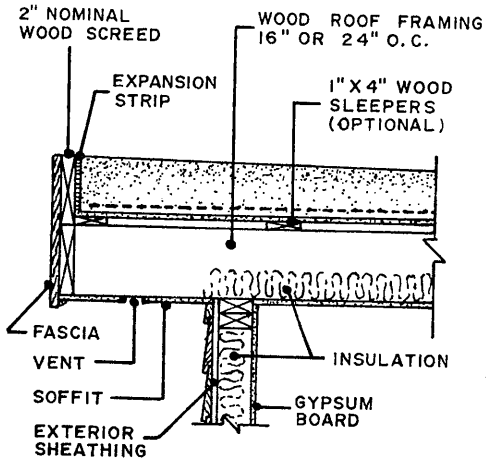

FIREWALL

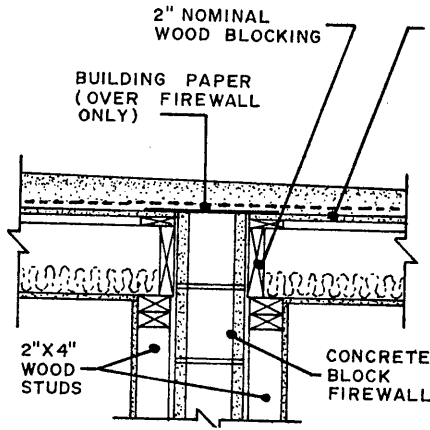

ROOF DRAIN

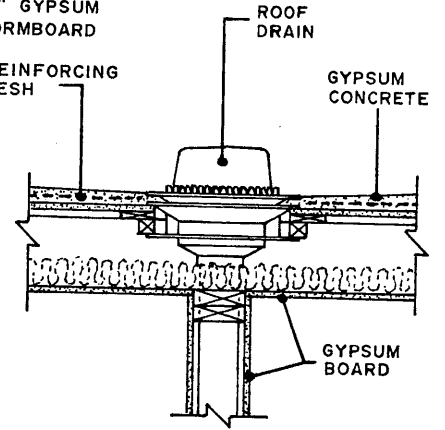

WALL DETAILS

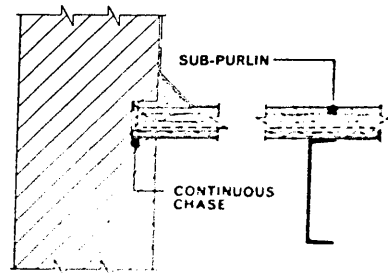
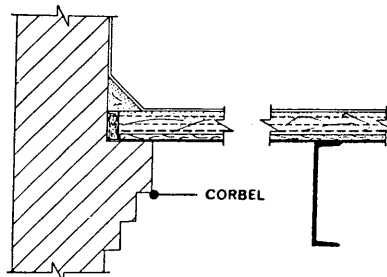
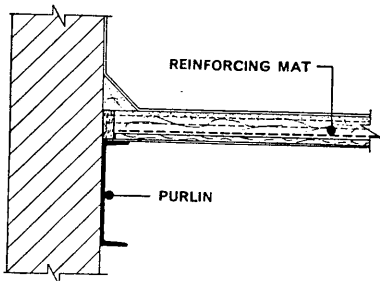
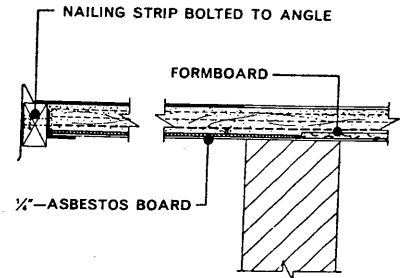
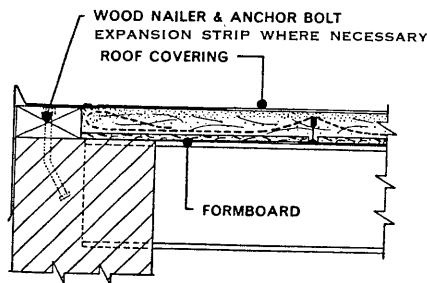
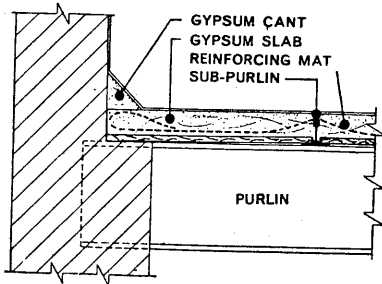

CURB DETAIL

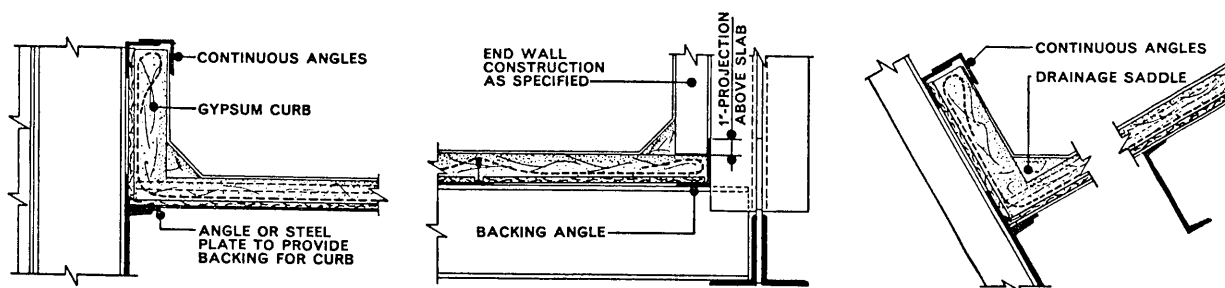

RIDGE DETAIL

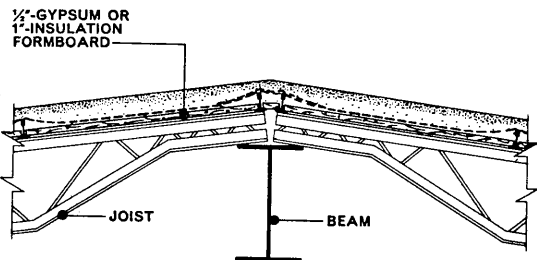

VALLEY DETAIL

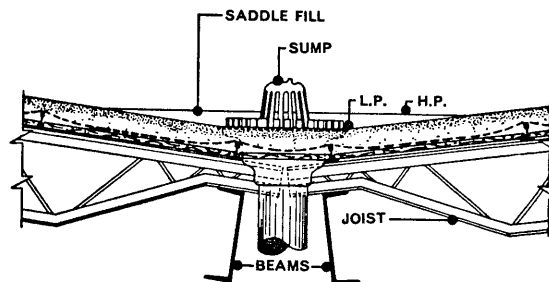

EXPANSION JOINT

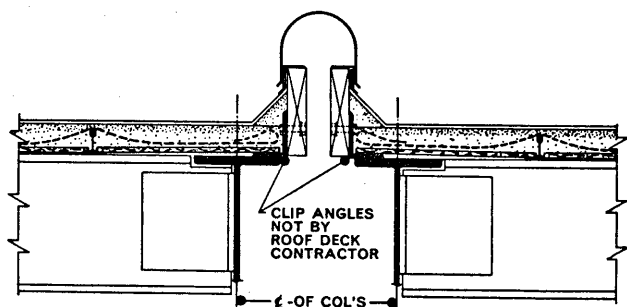

SKYLIGHT DETAIL

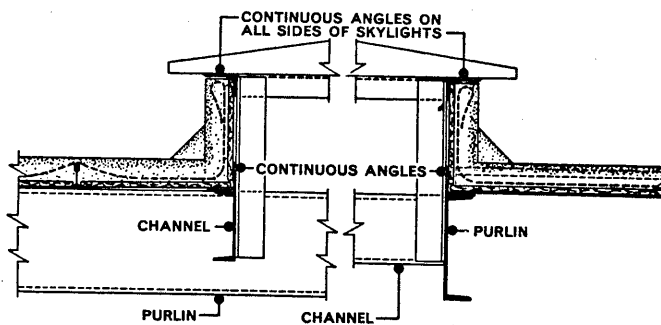

TYPICAL SEISMIC DETAILS SHOWING SHEAR TRANSFER DESIGNS OVER STEEL FRAMING*

SUB-PURLINS PARALLEL TO SHEAR RESISTING ELEMENTS

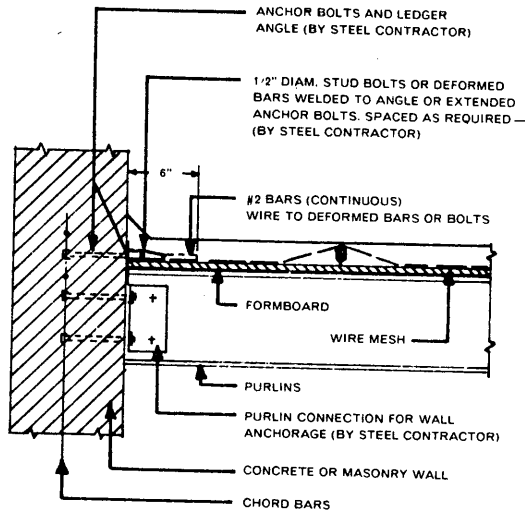

ROD DOWEL ATTACHMENT

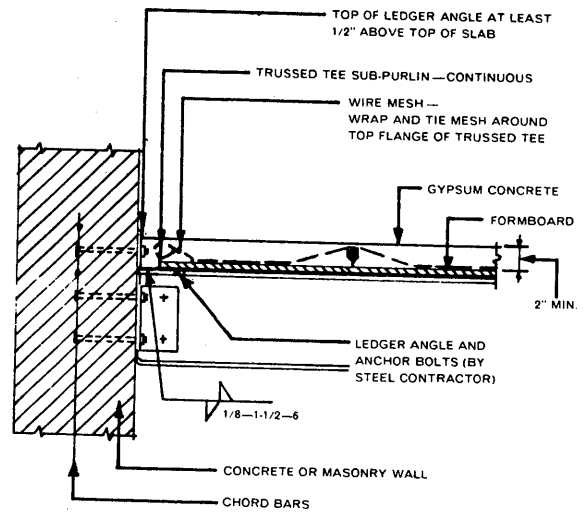

TRUSSED TEE ATTACHMENT

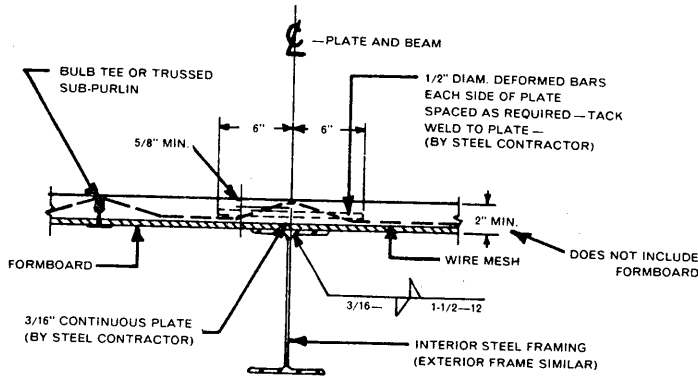

ROD DOWEL AT BEAM

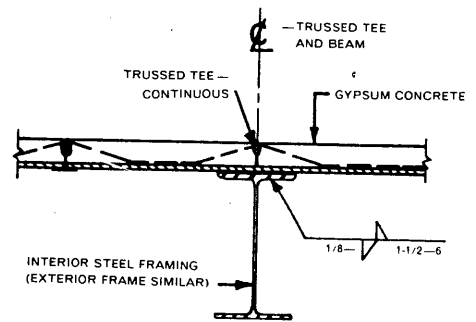

TRUSSED TEE AT BEAM

SUB-PURLINS PERPENDICULAR TO SHEAR RESISTING ELEMENTS

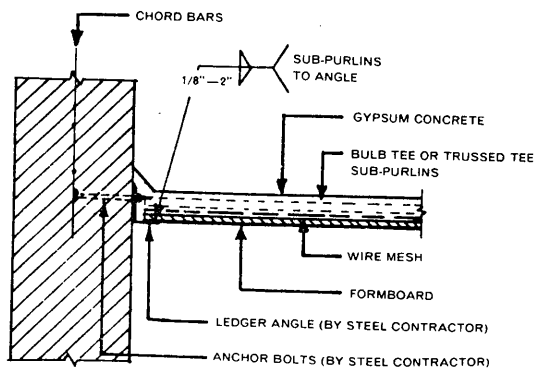

EXTERIOR WALL

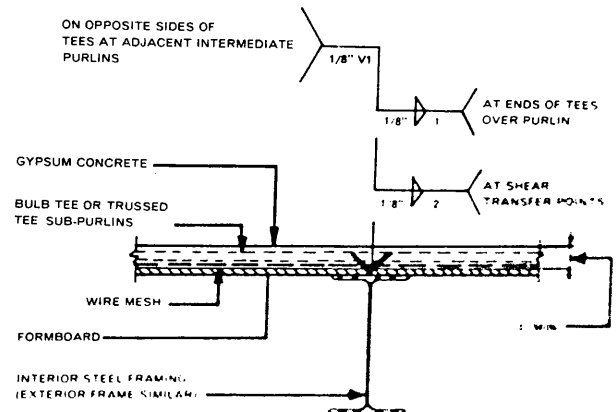

STEEL FRAMING

*BY S. B. BARNES AND ASSOCIATES

SPECIFICATIONS

WITH SUBPURLINS

1. SCOPE

The contractor shall furnish all labor, material and equipment to complete the installation of the poured gypsum concrete roof decks, together with cants, curbs and drainage fills as shown and specified. Approved shop drawings may be required before work proceeds.

2. MATERIALS

- A. *Subpurlins* – steel subpurlins shall be standard structural tees, special section bulb tees, or trussed tees. They shall be of proper weight and section to support the required dead and live loads. They shall be shop painted with one coat of approved paint.
- B. *Permanent formboards* shall be one of the following:
- 1) 1/2" gypsum formboard 32" wide in lengths equal to main purlin spacing. Where purlin spacings are 10' - 0" or greater, formboard should be one-half of the length of purlin spacing with approved galvanized or painted tees to support cross joints between subpurlins;
 - 2) 1", or 1 1/2" insulation formboard, 32" wide, in lengths equal to main purlin spacings;
 - 3) 3/4", 1", 1 1/4", 1 1/2", 1 3/4" or 2" glass or mineral fiber formboard, 24" or 32" wide (end joints should be supported by main purlins or sheet metal cross tees except where concealed by a ceiling);
 - 4) 1/4" x 32" x 48" asbestos formboard. End joints not supported by main purlins should be supported by galvanized or painted sheet metal cross tees.
- C. *Reinforcing mesh* shall be:
- 1) a galvanized woven wire reinforcement having a minimum tensile strength of 70,000 psi – 2" hexagonal mesh of No. 19 gauge and No. 16 gauge wires woven longitudinally every 3" across face of the mesh; or

- 2) welded galvanized wire mesh equivalent to No. 12 gauge longitudinal wires spaced 4" on centers and No. 14 gauge transverse wire spaced not over 8" on centers; or
- 3) an approved equivalent type mesh having an effective cross sectional area of not less than 0.026 sq. in. per foot of slab width.

- D. *Gypsum concrete* shall be calcined gypsum mill-mixed with wood chips, shavings, or mineral aggregate as desired. Only clean water shall be added. Compressive strength: Class A – 500 psi; Class B – 1,000 psi.

3. INSTALLATION

- A. *Subpurlins* shall be placed to fit formboard widths and welded to each main purlin using a fillet weld (1/2" minimum) placed on alternate sides of subpurlins.
- B. *Formboards* shall be placed on subpurlin flanges with all end or cross joints supported by main purlins or special cross-tees unless formboards are designed to prevent leak-through of the gypsum concrete at the joints during pouring. Formboard shall be cut to fit neatly all walls, curbs and openings as required.
- C. *Reinforcing mesh* shall be laid with the longitudinal wires at right angles to the subpurlins. Lap ends of mesh not less than 6". Sides of mesh shall not be lapped. Cut mesh to fit at walls, curbs and openings and carry mesh into all areas where gypsum concrete is to be poured.
- D. *Gypsum concrete* shall be mixed only with clean water at the job and poured in place over the forms and reinforcing to an average thickness of not less than 2". (The minimum cover over subpurlins shall be 1/4"). Screed all surfaces to a smooth even plane, ready to receive roof covering. Pour cants, curbs and drainage fills as shown or as required. After the slab has been poured, roof shall be left free and clean for other trades.

APPENDIX A

METHOD FOR DETERMINING COMPRESSIVE STRENGTH OF GYPSUM CONCRETE FROM FIELD SPECIMENS

(NOTE: Use only 2 in. split cube molds or 2 x 4 in. cylinders)

SCOPE

1. This method covers the procedure for preparing samples and testing the compressive strength of gypsum concrete as it is poured in place on the job.

SAMPLING

2. (a) The sample shall be obtained by passing a clean, dry, non-absorbent container through the stream of concrete as it is deposited in place upon the formboard from the hose, buggy or other conveyor.
- (b) Each sample shall consist of sufficient material to make a complete set of specimens as described in Section 4.
- (c) Each day's pour shall be sampled. At least one sample shall be taken for each 20,000 sq. ft. of slab that is poured. The location in the work where the sample is taken should be noted for future reference.
- (d) The procedures used in sampling shall include the use of every precaution which will aid in obtaining samples representing the true nature and condition of the concrete sampled.

MOLDS

3. Molds shall be made of non-absorbent material and shall be substantial enough to hold their form during the molding of test specimens. Molds shall be 2-in. split cube molds meeting

the requirements of ASTM Designation C472, or 2 x 4-in. open-end cylinder molds. Cylinder molds shall not vary from the standard diameter by more than one per cent, nor from the standard length by more than two per cent. Smooth and level plates at least 1/8 in. thick, of metal or plate glass, shall be provided for the molds.

NUMBER OF SPECIMENS

4. At least five specimens shall be made from each sample.

MAKING SPECIMENS

5. The molds, base and cover plates shall be cleaned and lightly coated with mineral oil. (Note: paraffined cardboard cylinders need not be coated with oil). The molds shall be filled as soon as possible (not more than five minutes) after the sample is taken using a spatula or rod to puddle the concrete as required to prevent entrapment of air and formation of voids. The molds shall be slightly overfilled, with the surplus material rounded at the top. The cover plates shall then be placed on the tops of the molds and firmly pressed down so as to squeeze out the surplus material while avoiding entrapment of air bubbles. This operation shall be completed before the concrete has begun to set. The cover plates shall be removed as soon as practicable but not until the concrete has set. As an alternative to the use of cover plates of the molds may be screeded smooth and leveled using a broad knife.

TESTING PROCEDURE

6. (a) The specimens may be removed from the molds as soon as they have hardened, and must be removed from the molds before drying and testing. The specimens shall be protected from freezing and delivered to the testing laboratory within seven days from the time they are made.
- (b) Before testing, the specimens shall be dried by storing them in moving air at a temperature of not less than 90°F. nor more than 110°F., at a relative humidity of not more than 50 per cent. Weigh the specimens at one-day intervals until the weight change between successive readings is not more than one per cent. Remove the specimens when dry, place them in a desiccator over anhydrous calcium chloride for 24 hours, remove and test immediately. The dry density shall be determined in accordance with ASTM Designation C472.
- (c) The testing machine shall be of any type of suitable capacity which will provide the rate of loading pre-

- scribed in Paragraph 6 (e).
- (d) If the specimens are cubes, they shall be positioned in the testing machine so that the load is applied on the surface formed by the faces of the molds, not on the top and bottom.
- (e) The load shall be applied at a constant rate without shock and within the range of 15 to 40 psi per sec. Increase the load until the specimen fails and record the maximum load carried by the specimen.

REPORT

7. Calculate the load as lb. per sq. in., and report the average compressive strength of the specimens from each sample, expressing the result to the nearest five lb. per sq. in. Report the dry density of each specimen as determined in accordance with Paragraph 6 (b) above. Any specimen in a test showing manifest evidence of improper sampling, molding, storage or testing shall be discarded, and the remaining strength averaged. If the number of remaining specimens is less than three, the results from the entire sample shall be discarded.

FIRE RESISTANCE RATINGS

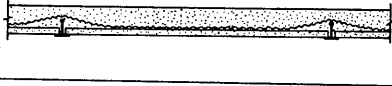
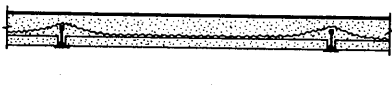
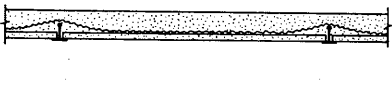
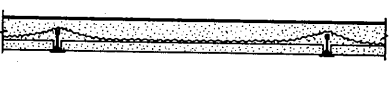
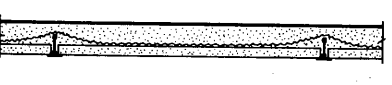
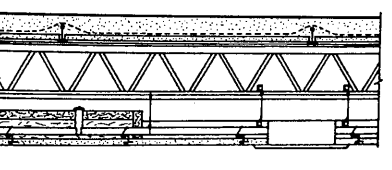
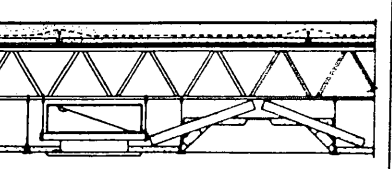
Fire Rating	Construction Type	GA Code	SKETCH	CONSTRUCTION DETAILS	Fire Test Reference
1 HR	Gypsum Concrete Gypsum Formboard Subpurlins	RD 1110		2" gypsum concrete reinforced with 48-1214 welded wire fabric on 1/2" gypsum formboard on exposed subpurlins (bulb tees) with no ceiling.	NBS-400
	Gypsum Concrete Gypsum Formboard Subpurlins	RD 1210		2" gypsum concrete roof reinforced with 19 ga. reinforcing mesh and covered with asphalt-saturated felt roofing. Deck laid on 1/2" gypsum formboards supported by trussed tee subpurlins over steel beam not more than 9 feet apart. No ceiling. (Passed 90 minute fire test.)	UL R 5790-1 Design RC-4-1 1/2
2 HR	Gypsum Concrete Gypsum Formboard Subpurlins	RD 2110		2 1/2" thick gypsum concrete, reinforced with 48-1214 welded wire fabric (1/2" self-furring or furred 1/2" above formboard). 1/2" gypsum formboard on exposed subpurlins (bulb tees) with no ceiling. 2 hour restrained or unrestrained assembly.	NBS-406
	Gypsum Concrete Mineral Fiber Acoustical Formboard Subpurlins	RD 2210		2" lightweight gypsum concrete reinforced with woven wire mesh on 1" mineral fiber acoustical formboard or 1" insulation formboard. Trussed tee subpurlins spaced 32 3/4" o.c. with 1" long welds each side of subpurlin over steel beams not more than 7' apart. No ceiling.	UL Design RC-15-2 or P 677
	Gypsum Concrete Gypsum Formboards Subpurlins	RD 2310		2" gypsum concrete roof deck reinforced with 19 ga. reinforcing mesh and covered with an asphalt-saturated 3-ply felt roof. Deck laid on 1/2" gypsum formboards supported by trussed tee subpurlins over steel beams with 1 1/2" welds each side of subpurlins. Beams not more than 8 ft. apart. No ceiling.	UL R 5790-1 Design RC-23-2 or P 676
	Gypsum Concrete Gypsum Formboard Insulation Formboard Subpurlins Acoustical Ceiling	RD 2420		2" lightweight or regular gypsum concrete reinforced with 48-1214 welded wire fabric on 1/2" gypsum formboard or 1" insulation formboard supported by bulb tee subpurlins on bar joists. Suspended ceiling acoustical tile. Two hour restrained assembly, one and one half hour unrestrained assembly.	UL R 4351-17 Design RC-13-2 or P 002
		RD 2460		1 1/2" (min.) gypsum concrete reinforced with 48-1214 welded wire fabric on 1/2" gypsum formboard or 1" insulation formboard supported by steel bulb tees welded, or sheet metal tees clipped to bar joists. Suspended ceiling of acoustical ceiling board, listed by UL for Design RC-6-2. Two hour restrained assembly, one and one half hour unrestrained assembly.	UL R 4351-6 Design RC-6-2 or P 207